

Anritsu Advancing beyond

Field Master™

Handheld RF Spectrum Analyzer

MS2080A

9 kHz to 4 GHz

9 kHz to 6 GHz



Introduction

Anritsu is proud to introduce the next line in handheld spectrum analyzer with real-time spectrum analysis. With frequency coverage up to 6 GHz, the new Field Master™ MS2080A completely redefines the standards for portable handheld analyzers, setting another new industry benchmark for performance and accuracy. The new MS2080A is the culmination of over 60 years of microwave test and measurement equipment development, using the very latest technologies to deliver accuracy and precision in measurements previously reserved only for benchtop instruments.

Instrument Highlights

- Modulation Bandwidth: 20 MHz standard
40 MHz with Option 102
- Dynamic Range: > 105 dB Typical
- DANL: -167 dBm Typical with Preamp On
- Sweep Speed: 45 GHz/s (Option 102)
- Residual Spurious: <-120 dBm, preamp on
- Resolution Bandwidth (RBW): 1 Hz up to 5 MHz
- RTSA with 2.5 μs POI
- Built In Preamp In Included as Standard
- Battery Life > three hours
- Level Accuracy: ±1 dB

Capabilities and Functional Highlights

- 5GNR FDD/TDD FR1 Analyzer
- Real-Time Spectrum Analyzer
- LTE FDD and TDD Analyzer
- WCDMA FDD Measurement
- IQ Waveform Capture/Streaming
- Spectrogram
- Gated Sweep
- AM/FM Audio Demodulation
- Field Strength
- EIRP
- Occupied Bandwidth
- Channel Power
- Adjacent Channel Power
- Spectral Emissions Mask
- Signal Strength and RSSI
- Carrier Aggregation
- Coverage Mapping in SPA, 5GNR, and LTE
- Carrier-to-Interference
- Channel Scanner
- Trace Recording/Playback
- High Accuracy Power Measurements (external sensor sold separately)
- Cable and Antenna Analyzer
- Time Domain Reflectometry (TDR) measurements (Ohm/Linear)
- Interference Finder
- Multi-language Support
- Built-in PDF Report Generator

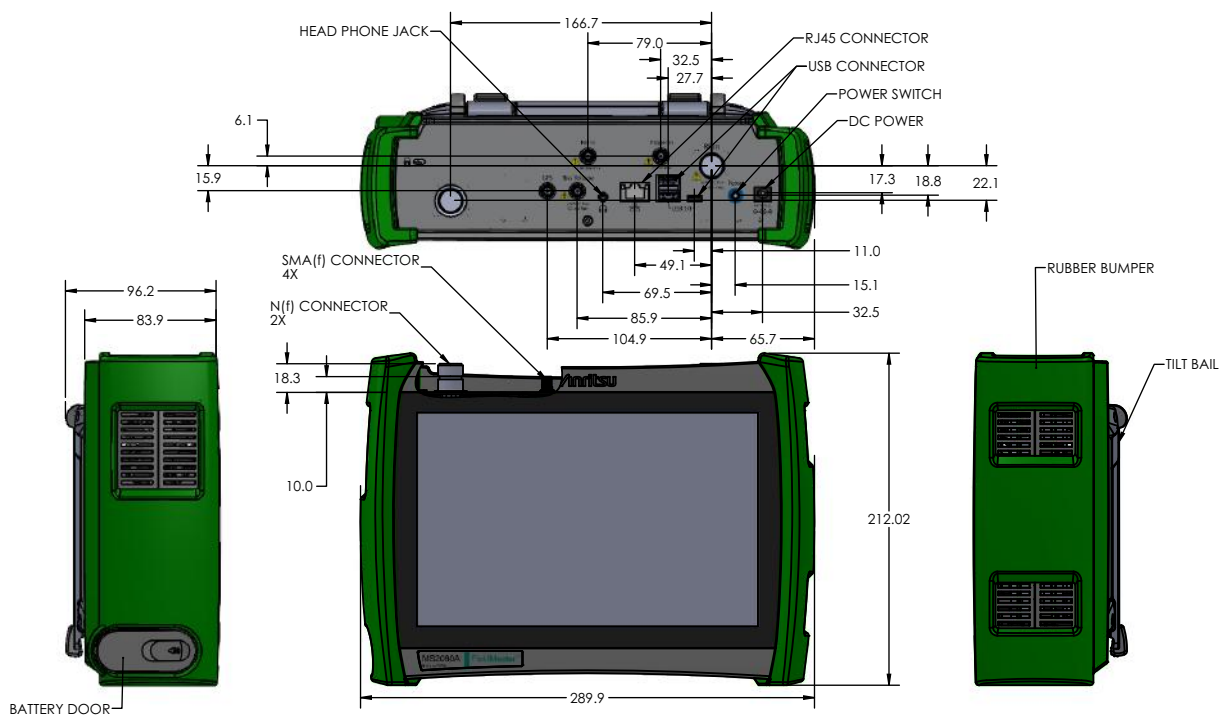

MS2080A

All dimensions in mm

Table of Contents

Spectrum Analyzer Features4

Spectrum Analyzer Performance5

Secure Communication (Option 17)7

High Accuracy Power Meter (Option 19)7

Interference Finder and AM/FM Audio Demodulation (Option 24)7

Channel Scanner (Option 27).....8

GNSS Receiver (Option 31).....8

Gated Sweep (Option 90)8

IQ Waveform Capture (Option 126)9

IQ Waveform Streaming (Option 127)9

Real-Time Spectrum Analyzer Features (Option 199)10

Cable and Antenna Analyzer11

Time Domain Reflectometry (TDR) Measurement (Option 3).....11

Coverage Mapping (Option 431).....12

Electromagnetic Field (EMF) Measurement (Option 444)13

AM/FM Modulation Measurement (Option 509).....13

WCDMA FDD Signal Analyzer (Option 871)14

LTE FDD/TDD Signal Analyzer (Option 883).....15

5G NR FDD/TDD FR1 Signal Analyzer (Option 888)17

General Specifications18

Programmable Remote Control19

Anritsu Remote and Report Tools (ARRT)20

Ordering Information – Instrument Options21

Standard Accessories22

Related Manuals22

USB Power Sensors and S331P Site Master Cable and Antenna Analyzer23

Optional Accessories.....24

Definitions

Specifications	All specifications and characteristics apply to Revision 2 instruments under the following conditions, unless stated otherwise: <ul style="list-style-type: none"> • After 10 minutes of warm-up time, where the instrument is left in the ON state • When using the internal 10 MHz reference signal
Typical Performance	Typical specifications are not tested and are not warranted. They are generally representative of characteristic performance.
Nominal Performance	Nominal specifications are design parameters; they are not tested and are not warranted.
Calibration Cycle	Calibration is within the recommended 12 month period Specifications are subject to change without notice. For the most current data sheet, please visit the Anritsu website: www.anritsu.com .

Spectrum Analyzer Features

Smart Measurements

Field Strength	Measures field strength (dBm/m ² , dBW/m ² , dBV/m, dBmV/m, dBμV/m, V/m, W/m ² , W/cm ² , A/m) with antenna gain vs. frequency plot
Channel Power	Measures the total power and power spectral density within a specified bandwidth
Occupied Bandwidth	Measures the 99 % to 1 % power channel of a signal
Adjacent Channel Power	Measures the channel power of the adjacent channel
Spectral Emission Mask	Standards based limits for wireless emissions
Carrier-to-Interference (C/I)	Measures the ratio of power (dB) in an RF carrier to the interference power in the channel
Burst Power Average	Measures average power between two time markers in zero span

Setup Parameters

Frequency	Center/Start/Stop, Frequency Step, Frequency Offset, Gestures
Span	Span (Manual/Increment 1, 2, 5), Full Span, Last Span, Zero Span
Amplitude	Reference Level (Manual/Auto and Offset), Scale/Division, Y-Axis Unit (dBm, dBW, dBV, dBmV, dBμV, dBA, V, W, A), Preamp (On/Off), Attenuation (Auto/Manual), Attenuation Level, Impedance (50 Ω, 75 Ω, other), Custom IMP Loss, Field Strength, Gestures
Bandwidth	RBW/VBW (Auto/Manual), VBW Type (Linear/Logarithmic), RBW:VBW Ratio, SPAN:RBW Ratio
Sweep	Continuous on/off, Restart, Sweep Once, Sweep to N, Auto/Manual Time, Gated Sweep (see “Gated Sweep (Option 90)” on page 8)

Spectrogram

Number of Lines	142
Trace Time/Position Cursor	Up to six cursors (display historical trace data by trace position or time)
Cursor State	Active, Hold/View, Blank
Color Setup	Color Scale Top/Bottom Range, Reference Hue, Preset Setup

Trace Functions

Traces	Up to Six Traces
Trace Type	Clear/Write, Average (2 to 1000), Max Hold, Min Hold, Rolling Average, Rolling Max Hold, Rolling Min Hold
Trace Math	T1-T2, T2-T1 (when T5 and T6 are selected)
Trace Mode	Active, Hold/View, Blank
Detector Type per Trace	Peak, RMS/Avg, Negative, Sample, Normal
Trace Normalize	On/Off (defines a 0 dB reference trace)
Trace Record	Record live samples with manual tagging to internal or external storage
Trace Playback	Play recorded samples from internal or external storage; set playback interval
CSV Logging	Record live or playback traces in CSV format for post processing

Trigger Functions (zero span only)

Trigger Input Sources (zero span only)	Free Run, Video, External
Settings	Level, Delay, Holdoff, Periodic, Slope (Rising/Falling), Hysteresis Refer to “IQ Waveform Capture (Option 126)” on page 9 for IQ Trigger Functions

Marker Functions

Markers	Up to 12 Markers
Marker Measurements	Amplitude, Frequency (swept spectrum display) Amplitude, Time (Zero Span)
Marker Mode	Normal, Delta, Fixed
Delta Marker	Relative to any Normal or Fixed Marker
Marker Function	None, Noise, Frequency Counter (1 Hz, 100 mHz, 10 mHz, 1 mHz resolutions), Quasi-Peak (per CISPR 16-1-1)
Marker Trace	Assign Marker to any Trace
Peak Search	Peak Search, Next Peak, Next Peak Left, Next Peak Right, Next Point Left, Next Point Right
Peak Search Setup	Peak Threshold, Peak Excursion
Marker	Mkr → Center, Mkr → Ref Level
Marker Table	Up to 12 Markers Showing Marker, Mode, Function, Trace, Frequency, Amplitude, Delta Frequency & Offset

Limit Line Functions

Limit Setup	Upper/Lower, Limit On/Off, Limit Alarm On/Off, Set Default Limit Line, Frequency Mode (Absolute/Relative), Amplitude Mode (Absolute/Relative)
Limit Line Edit	Frequency, Amplitude, Add Point, Add Vertical, Add Gap, Delete Point, Next Point Left/Right
Limit Line Move	Center, X-Offset (Hz), Left, Right, Y-Offset, Up, Down, To Marker 1, Marker 1 Offset (dB)
Limit Line Envelope	Select Envelope (Upper/Lower), Set Envelope, Envelope Points (2-41), Amplitude Offset, Shape (Square/Slope)

Spectrum Analyzer Performance

Frequency (usable to 0 Hz)

MS2080A-0704	9 kHz to 4 GHz (Option 704)
MS2080A-0706	9 kHz to 6 GHz (Option 706)
Tuning Resolution	1 Hz
Span	10 Hz to max frequency, Zero Span
Frequency Reference	Internal, GNSS, External
Internal Frequency Reference	Standard TCXO: Aging: $\pm 1.0 \times 10^{-6}$ per year Accuracy: $\pm 2.8 \times 10^{-7}$ (-10°C $\pm 55^\circ\text{C}$) plus aging (see "GNSS Receiver (Option 31)" on page 8 for improved accuracy)
External Frequency Reference	10 MHz, -10 dBm to +10 dBm

Bandwidth

Analysis Bandwidth	20 MHz (standard), 40 MHz (Option 102)
RTSA Bandwidth	20 MHz (standard), 40 MHz (Option 102)
Resolution Bandwidth (RBW)	1 Hz to 5 MHz, 1 Hz to 10 MHz in zero span (standard), 1 Hz to 20 MHz in zero span (Option 102)
RBW Selectivity	4:1 nominal (-60 dB / -3 dB)
Video Bandwidth (VBW)	0.1 Hz to 5 MHz, 1 Hz to 10 MHz in zero span (standard), 1 Hz to 20 MHz in zero span (Option 102)
CISPR Bandwidth	Resolution bandwidth when using Quasi-Peak marker function: 200 Hz, 9 kHz, and 120 kHz
VBW/Average Type	Linear/Log

Sweep

Manual Sweep	Maximum sweep time is 3600 s (1 hour)
Sweep Points	10 to 10,001 (1001 in zero span)
Sweep Rate (non-zero span)	32 GHz/s (standard), 45 GHz/s (Option 102)

Zero Span

Sweep Time	60 ns to 3600 s in zero span
Sweep Time Accuracy	$\pm 2\%$ in zero span

Spectral Purity – SSB Phase Noise

Offset from 1 GHz RF Input	Maximum	Typical
10 kHz	-93 dBc/Hz	-94 dBc/Hz
100 kHz	-95 dBc/Hz	-97 dBc/Hz
1 MHz	-120 dBc/Hz	-123 dBc/Hz

Spurs

Residual Spurious	< -120 dBm (RF input terminated, 0 dB input attenuation, > 20 MHz, preamp On) < -105 dBm (RF input terminated, 0 dB input attenuation, > 20 MHz preamp Off)
Input-Related Spurious	< -70 dBc (0 dB attenuation, -30 dBm input)
Exceptions, typical	< -68 dBc @ 700 MHz to 3300 MHz with 2086 MHz Input < -65 dBc @ $2*(F1 - 1484)$ MHz, where $3140 \text{ MHz} < F1 < 3580 \text{ MHz}$ < -68 dBc @ $F1 - 2086$ MHz where $2100 \text{ MHz} < F1 < 4970 \text{ MHz}$
Local-Oscillator Related Spurious	< -60 dBc nominal for offsets > 1 MHz

Amplitude Ranges

Dynamic Range	105 dB typical at 1 GHz, 2/3 (TOI-DANL) in 1 Hz RBW
Measurement Range	DANL to +30 dBm
Display Range	1 to 15 dB/div in 1 dB steps, ten divisions displayed
Reference Level Range	-150 dBm to +30 dBm
Attenuator Resolution	0 to 50 dB, 5 dB steps
Reference Level Offset	99.9 dB external loss to 99.9 dB external gain
Maximum Continuous Input	+30 dBm CW, ± 50 VDC (≥ 10 dB attenuation) +23 dBm CW, ± 50 VDC (< 10 dB attenuation) +10 dBm CW, ± 50 VDC (preamp ON)
Damage Level	5 W (+37 dBm) to 6 GHz

Amplitude Accuracy (≥ 10 dB attenuation, -50 dBm \leq input signal \leq -10 dBm, 1 kHz RBW, auto-coupled, excluding effects of VSWR, noise, and spurs. Values below 100 kHz are with preamp off)

	20°C to 30°C (after 30 minute warm-up)		-10°C to 55°C (after 60 minute warm-up)	
Frequency Range	Maximum	Typical	Maximum	Typical
9 kHz to 6 GHz	± 1.0 dB	± 0.5 dB	± 2.0 dB	± 0.5 dB

Displayed Average Noise Level (DANL) (RMS detection, VBW/Avg type = Log, reference level = -20 dBm for preamp Off and -50 dBm for preamp On, auto attenuation On, normalized to 1 Hz RBW)

Frequency Range	Preamp = On		Preamp = Off	
	Maximum	Typical	Maximum	Typical
10 MHz to 2 GHz	-161 dBm	-167 dBm	-142 dBm	-150 dBm
> 2 GHz to 4 GHz	-160 dBm	-165 dBm	-140 dBm	-146 dBm
> 4 GHz to 5 GHz	-157 dBm	-162 dBm	-137 dBm	-144 dBm
> 5 GHz to 6 GHz	-152 dBm	-160 dBm	-133 dBm	-142 dBm

Third-Order Intercept (TOI) (-20 dBm tones 100 kHz apart, 0 dB input attenuation, preamp Off, reference level -20 dBm)

1 GHz	+7 dBm, Typical
2 GHz	+11 dBm, Typical
3 GHz	+14 dBm, Typical
4 GHz	+13 dBm, Typical
5 GHz	+15 dBm, Typical
6 GHz	+17 dBm, Typical

Second Harmonic Distortion (0 dB input attenuation, -30 dBm input, preamp Off)

50 MHz	-65 dBc maximum
> 50 MHz to 3 GHz	-70 dBc, typical

VSWR (≥ 10 dB input attenuation)

9 kHz to 2.0 GHz	1.5:1 typical
2 GHz to 6.0 GHz	1.8:1 typical

Secure Communication (Option 17)

When connecting the instrument to a network, Option 17 creates a secure tunnel. Ports will be closed, and data encrypted as shown in the table below. Security certificates can be loaded onto the instrument to establish a secure connection. Remote access to the MS2080A ports can be password protected. The USBTMC connection interface does not work with instruments installed with secure communication Option 17.

PORT	SERVICE	DEFAULT STATE	WITH OPTION 17
21 (tcp)	ftp	Open	Closed
80 (tcp)	http	Open	Closed
111 (tcp)	rpcbind	Open	Open
443 (tcp)	https	Open	Open
8001 (tcp)	vcom-tunnel	Open	Closed
8002 (tcp)	vcom-tunnel	Closed	Open (encrypted)
9001 (tcp)	tor-orport	Open	Closed
9002 (tcp)	dynamid	Open	Closed
9003 (tcp)	tor-orport	Closed	Open (encrypted)
9004 (tcp)	dynamid	Closed	Open (encrypted)
24001 (tcp)	med-fsp-rx	Open	Closed
24002 (tcp)	med-fsp-rx	Closed	Open (encrypted)
111 (udp)	rpcbind	Open	Open
123 (udp)	ntp	Open	Open
5353 (udp)	Zeroconf	Open/Filtered	Open

High Accuracy Power Meter (Option 19) (requires external USB power sensor, sold separately)

Amplitude Setup	Maximum Display, Minimum Display, External Gain, External Loss, Relative Power On/Off, Units (dBm, W)			
Zero/Cal Limits	Zero, Cal Frequency, Signal Standard			
	Limit On/Off, Upper/Lower Limit, Alarm On/Off			
Power Sensor Model	MA24106A	MA24108A/18A/26A	MA24208A/18A	MA24330A/40A/50A
Description	High Accuracy RF Power Sensor	Microwave USB Power Sensor	Microwave Universal USB Power Sensor	Microwave CW USB Power Sensor
Frequency Range	50 MHz to 6 GHz	10 MHz to 8/18/26 GHz	10 MHz to 8/18 GHz	10 MHz to 33/40/50 GHz
Connector	Type N(m), 50 Ω	Type N(m), 50 Ω (8/18 GHz) Type K(m), 50 Ω (26 GHz)	Type N(m), 50 Ω	Type K(m), 50 Ω (33/40 GHz) Type V(m), 50 Ω (50 GHz)
Dynamic Range	-40 dBm to +23 dBm (0.1 μW to 200 mW)	-40 dBm to +20 dBm (0.1 μW to 100 mW)	-60 dBm to +20 dBm (1 nW to 100 mW)	-70 dBm to +20 dBm (0.1 nW to 100 mW)
Measurand	True-RMS	True-RMS, Slot Power, Burst Average Power	True-RMS, Slot Power, Burst Average Power	Average Power
Measurement Uncertainty	±0.16 dB ^a	±0.18 dB ^b	±0.17 dB ^c	±0.17 dB ^d
Data Sheet (for complete specifications)	11410-00424	11410-00504	11410-00841	11410-00906
Notes:	a. Total RSS measurement uncertainty (0 °C to 50 °C) for power measurements of a CW signal greater than -20 dBm with zero mismatch errors. b. Expanded uncertainty with K=2 for power measurements of a CW signal greater than -20 dBm with zero mismatch errors. c. Power uncertainty expressed with two sigma confidence level for CW measurement after zero operation. Includes calibration factor and linearity over temperature uncertainties, but not the effects of mismatch, zero set and drift, or noise. d. Includes linearity over temperature uncertainties, but not the effects of calibration factor, mismatch, zero set and drift, and noise.			

Interference Finder and AM/FM Audio Demodulation (Option 24) (requires GNSS Receiver (Option 31)), directional antenna recommended, sold separately

The interference finder option is available in spectrum analyzer or RTSA (Option 199).

Supported Features

- Interference Finding Audio Tone
- AM/FM Audio Demodulation
- Interference Triangulation Mapping (recommended InterferenceHunter™ MA2700A)
- Interference Polar Plot (requires InterferenceHunter MA2700A)

Interference Finder Audio Tone (for use with directional antennas, sold separately)

Setup	Integration Bandwidth, Power Limit (on/off), MAX/MIN Level, Volume, Mute (on/off)
Audio Tone	20 Hz to 20 kHz (tone pitch and volume changes with detected signal strength)

AM/FM Audio (

Demod Frequency	Full range of instrument
Audio Demodulation	AM, USB, LSB, Wideband FM, Narrowband FM (6.25, 12.5 and 25 kHz)
Markers	Selectable demodulation marker (1 to 12)
Audio	Toggle On/Off
Volume	Set 0 % to 100 %
Record Audio	Record audio up to 100,000 s (dependent on instrument memory)
Squelch Level	-120 dBm to +30 dBm (set RF level threshold to break audio silence, supports log and linear units)
RF Spectrum Setup	Show Density (On/Off), Auto Scale (On/Off), Density Scale Top/Bottom (0 to 100%) Density Resolution (Normal/High), Persistence State (Variable/Infinite), Acquisition Time (0.05 to 5 s)

Interference Map Triangulation (recommended for use with InterferenceHunter MA2700A handle and requires directional antenna, sold separately. If not using MA2700A, Option 31, GNSS and antenna are required)

Triangulation	Triangulates on source of interference location using eCompass and digital maps displayed on screen
Manual Setup	Manual entry of compass bearing values

Interference Polar Plot (requires InterferenceHunter MA2700A handle and directional antenna, sold separately)

Signal Strength Radar Plot	360° radar plot of single frequency signal strength centered on current GNSS location
----------------------------	---

Channel Scanner (Option 27)

Number of Channels	1 to 60
Frequency Range	9 kHz to 4/6 GHz
Frequency Accuracy	$\pm 2.8 \times 10^{-7}$
Measurement Range	-160 dBm to +30 dBm
Amplitude	Reference Level (Manual/Auto and Offset), Scale/Division, Preamp (On/Off), Attenuation (Auto/Manual), Y-Axis Unit (dBm, dBW, dBV, dBmV, dBuV, dBA, V, W, A), Attenuation Level, Impedance (50 Ω , 75 Ω , other), Custom IMP Loss, Field Strength
Scan	Continuous (on/off), Scan Once
Measure	View: Bar Chart, Strip Chart, Mapping, Start Measure, Select Points (on/off), Clear Points
Setup Parameters	Add Channels Signal Standard: Start Channel, Channel Step Size, Channel Span, Channel Count, Index, Dwell Time, Upper Limit, Lower Limit Frequency Range: Channel Name, Start Frequency, Channel Spacing, Channel Span, Channel Count, Index, Dwell Time, Upper Limit, Lower Limit Custom: Channel Name, Center Frequency, Channel Span, Index, Dwell Time, Upper Limit, Lower Limit Map Type (Outdoor, Indoor), Map Mode (RSSI, Channel Power, Spectral Density), Repeat Type (Time, Distance), Time (1 to 60 s max), Distance, Distance Unit (Meters, Feet), Best Channel (on/off), Selected Channel (0 to 59), Color Setup: Excellent, Very Good, Good, Fair, Poor

GNSS Receiver (Option 31) (Requires GNSS antenna, sold separately)

Supported Satellite Systems	GNSS (includes combinations of GPS, GLONASS, Galileo, BeiDou)
Setup	On/Off, Antenna Voltage 3.3 V/5.0 V, GPS/GNSS Info
GNSS Time/Location Indicator	UTC Time, Latitude, Longitude, and Altitude on display (UTC Time and Altitude on GNSS Info display)
High Frequency Accuracy	$< \pm 2.5 \times 10^{-8}$ with GNSS On, 3 minutes after satellite lock in selected mode (GNSS antenna connected)
Connector	SMA, female

Gated Sweep (Option 90)

Gate Source	GNSS (GPS), External
Trigger Slope	Rising/Falling
Frame Time	1 s, 20 ms, 10 ms
Gate Delay	up to 200 ms
Gate Length	1 μ s up to 200 ms
Power vs. Time, Display Length	100 μ s to 200 ms

IQ Waveform Capture (Option 126)

(Option 126 is non-export controlled and limits bit depth to 8 or 10 bits when bandwidth is 40 MHz)

IQ Capture

Mode	Spectrum Analyzer, RTSA
Capture Mode	Single, Continuous, Streaming
Capture Settings	Capture Length, Time Stamps (on/off), Save to File (Automatic/Normal), Save Capture, File Name Prefix Capture Signing (on/off), Storage Device (Internal/USB)
Trigger Source	Free Run, External, Video
Trigger Settings	Time Stamps (on/off), Level, Delay (negative in RTSA mode only), Time Interval, Slope (Rising/Falling), Hysteresis
Maximum Sample Rate ^a	50 MHz
Maximum Signal Bandwidth ^a	40 MHz
Bit Resolution	8, 10, 16, or 32-bit
Total Capture Memory	2 GB

IQ Capture Time Typical Maximum

Signal Bandwidth (MHz)	IQ Sample Rate (MSPS)	IQ Bit Resolution				Mode ^a	
		32 bit	16 bit	10 bit	8 bit	SPA	RTSA
40	50	5.37 s	10.74 s	17.18 s	21.47 s	x	x
36	46.08	5.83 s	11.65 s	18.64 s	23.3 s	x	
25	30.72	8.74 s	17.48 s	27.96 s	34.95 s	x	
20	25	10.74 s	21.47 s	34.36 s	42.95 s	x	x
18	23.04	11.65 s	23.30 s	37.28 s	46.6 s	x	
12	15.36	17.48 s	34.95 s	55.92 s	1.17 min	x	
10	12.5	21.47 s	42.95 s	1.15 min	1.43 min	x	x
6	7.68	34.95 s	1.17 min	1.86 min	2.33 min	x	
5	6.25	42.95 s	1.43 min	2.29 min	2.86 min	x	x
3	3.84	1.17 min	2.33 min	3.73 min	4.66 min	x	
2.5	3.125	1.43 min	2.86 min	4.58 min	5.73 min	x	x
1.5	1.92	2.33 min	4.66 min	7.46 min	9.32 min	x	
1.25	1.5625	2.86 min	5.73 min	9.16 min	11.45 min	x	x
0.28	0.36	12.43 min	24.86 min	39.77 min	49.71 min	x	
0.036	0.045	99.42 min	198.84 min	318.15 min	397.68 min	x	

a. Option Dependent: Standard Analysis Bandwidth up to 20 MHz, Option 102 up to 40 MHz.

IQ Waveform Streaming (Option 127) (requires Option 126; Option 127 is non-export controlled and limits streams to 40 MHz BW or less.)

Bit Resolution	8, 10, 16, or 32-bit
Ethernet Port	Maximum gapless bandwidth depends on network transfer speed
USB Port	Requires USB 3.0 solid state drive. Device formatted as external file system (ext4). Maximum gapless streaming bandwidth: 8 bit: 40 MHz BW, 50 MSPS sample rate 10 bit: 40 MHz BW, 50 MSPS sample rate 16 bit: 40 MHz BW, 50 MSPS sample rate 32 bit: 25 MHz BW, 30.72 MSPS sample rate Device formatted as extensible file allocation table system (exFAT) with 32 MB allocation unit size. Maximum gapless streaming bandwidth: 8 bit: 40 MHz BW, 50 MSPS sample rate 10 bit: 40 MHz BW, 50 MSPS sample rate 16 bit: 40 MHz BW, 50 MSPS sample rate 32 bit: 25 MHz BW, 30.72 MSPS sample rate

Real-Time Spectrum Analyzer Features (Option 199)

Setup Parameters

Frequency	Center/Start/Stop, Frequency Step, Frequency Offset Gestures (Drag Center Frequency (on/off), Pinch Span (on/off))				
Span	Span, Full Span (max span: 20 MHz standard, 40 MHz with Option 102)				
Amplitude	Reference Level (Manual/Auto and Offset), Scale/Division, Y-Axis Unit (dBm, dBW, dBV, dBmV, dBμV, dBA), Preamp (on/off), Attenuation (Auto/Manual), Gestures (Drag Ref Level (on/off))				
Bandwidth	RBW (span dependent), Auto RBW, Span/RBW Ratio (1-100000)				
Probability of Intercept	Analysis Bandwidth	Density Resolution	Span	RBW	POI
	20 MHz (Standard)	Normal	20 MHz	3 MHz	3.036 μs
		High	20 MHz	3 MHz	4.929 μs
	40 MHz (Option 102)	Normal	40 MHz	5 MHz	2.464 μs
		High	40 MHz	5 MHz	4.357 μs
Density Color	Set Color Top/Bottom Range, Auto Scale				
Persistence	Infinite or Variable from 0 to 10 s				
Acquisition Time	50 ms to 5 s				
FFT Rate	527,000 FFT/s (normal resolution), 263,000 FFT/s (high resolution)				
Minimum Detectable Signal	9 ns				

Sweep Functions

Sweep	Single/Continuous, Sweep Once
-------	-------------------------------

Trace Functions

Traces	Up to Six Traces
Trace Type	Clear/Write, Average (2 to 1000), Max Hold, Min Hold, Rolling Average, Rolling Max Hold, Rolling Min Hold
Trace Mode	Active, Hold/View, Blank
Detector Type per Trace	Peak, Sample, Negative, Normal
Trace Record	Record live samples with manual tagging to internal or external storage (only applies to trace and not for spectral density graphic)
Trace Playback	Play recorded samples from internal or external storage; set playback interval (only applies to trace and not for spectral density graphic)
CSV Logging	Record live or playback traces in CSV format for post processing

Spectrogram

Number of Lines	142
Trace Time/Position Cursor	Up to Six Cursors (display historical trace data by trace position or time)
Cursor State	Active, Hold/View, Blank
Color Setup	Set Color Top/Bottom Range, Set Color Reference Hue

Marker Functions

Markers	Up to 12 Markers
Marker Measurements	Power, Frequency, Time (Spectrogram)
Marker Mode	Normal, Delta, Fixed
Delta Reference Marker	Relative to any Normal or Fixed Marker
Marker Function	None, Noise
Marker Trace	Assign Marker to any Trace
Peak Search	Peak Search, Next Peak, Next Peak Left, Next Peak Right, Next Point Left, Next Point Right
Peak Search Setup	Peak Threshold, Peak Excursion
Marker →	Mkr → Center, Mkr → Ref Level
Marker Table	On/Off, up to 12 Markers Showing Marker Mode, Function, Trace, Frequency, Amplitude, Delta Frequency & Offset

Limit Line Functions

Limit Setup	Upper/Lower, Limit On/Off, Limit Alarm On/Off, Set Default Limit Line, Frequency Mode (Absolute/Relative), Amplitude Mode (Absolute/Relative)
Limit Line Edit	Frequency, Amplitude, Add Point, Add Vertical, Add Gap, Delete Point, Next Point Left/Right
Limit Line Move	Center, X-Offset, Left, Right, Y-offset, Up, Down, Marker Offset, To Marker 1
Limit Line Envelope	Select Envelope (Upper/Lower), Envelope Points (41 max), Amplitude Offset, Shape (Square/Slope) Set Envelope

Cable and Antenna Analyzer (requires external Site Master™ S331P analyzer, sold separately)

Frequency

Frequency Ranges	150 kHz to 4 GHz (S331P-0704) 150 kHz to 6 GHz (S331P-0706)
Frequency Accuracy	± 2.5 ppm @ 23 °C ± 3 °C
Frequency Resolution	1 kHz

Refer to the Site Master S331P Technical Data Sheet (11410-00964) for hardware characteristics, performance specifications, compliance information, and related accessories for the S331P analyzer.

Smart Measurements

Return Loss	Measures the reflected power in dB
VSWR	Measures the ratio of voltage peaks to voltage valleys caused by reflections
Cable Loss	Measures the signal attenuation level of a cable
Distance-to-Fault (DTF) Return Loss/VSWR	Measures distance of the cable to facilitate precise fault location of components in a transmission line
1-Port Phase	Displays the phase of the reflection measurements at the RF port
Smith Chart	Converts the measured reflection coefficient data into complex impedance data
Transmission (USB Sensor)	Measures the loss (or gain) in dB of a device
TDR Linear /Ohm (Option 3)	Measures the impedance against distance

Setup Parameters

Frequency/Distance	Start Frequency, Stop Frequency
Distance and DTF Setup	Start Distance, Stop Distance, Units m/ft, Start Frequency, Stop Frequency, Point Count, Cable List, Cable Loss, Propagation Velocity
Windowing	Rectangular, Normal Side Lobe, Low Side Lobe, Minimum Side Lobe
Amplitude	Top, Bottom, Auto Scale, Full Scale
Measure	Count (1/2), Select (Trace 1/Trace 2), Display Layout (Single, Horizontal Split) with independent markers
Point Count	Flex Cal: 2 to 10,049, user defined Standard Cal: Snaps to nearest calibration point OSL Calibration: 10,049, 5025, 2513, 1257, 629, 315, 158, 65, 33, 17, 9, 5, 3 and 2 OSL + Trans (USB Sen)/Trans (USB Sen) Calibration: 1251, 626, 251, 126, 51, 26, 11, 6, 3 and 2
Sweep	Point Count, Run/Hold, Sweep Type (Single/Continuous), Sweep Rate (Normal/Fast), Sweep Once Averaging State (on/off), Sweep Averaging, Restart Averaging, RF Immunity (High/Low), RF In Hold (on/off)
Marker	Markers 1 to 8 (On/Off), Delta Markers 2 to 8 (Ref M1), Track Marker (On/Off), Marker Search (Peak/Valley), Marker Table (on/off), To Memory (On/Off), Mode (Reference), Independent Markers for Frequency and Distance Measurements
Limit	Upper Limit (on/off), Lower Limit (on/off), Upper/Lower Level Limit Test (On/Off), Move Active Limit, Edit Segments (42 upper and 42 lower segments maximum), Limit Alarm, Pass/Fail On/Off, Limit Preset
Calibration	Start/Cancel Calibration, Cal Setup, Cal Info, User Cal (On/Off), USB CAA Info, Power Sensor Method: OSL, OSL + Trans (USB Sen), Trans (USB sen), iOSL (only with ICN51A connected), iOSL + Trans (USB Sen) Type ¹ : Standard, FlexCal™
Trace	Copy To Memory, Memory Display (Trace, Memory, Both) Math: None, Trace - Memory, Trace + Memory, (Trace + Memory)/2, Smoothing (0 to 20%)
File	Quick Save, Save As, Recall, Browse Files, PDF Report: Report Setup, Template, Report Name, Generate Report, Preview Last Report

Time Domain Reflectometry (TDR) Measurement (Option 3) (Requires S331P, sold separately)

The TDR option complements the Distance-to-Fault (DTF) measurement by providing additional information about reflections in a transmission line. The resistive, capacitive and inductive component of individual reflections can be identified which provides an additional insight about the nature of the reflection. This information can be used in the identification and repair of faults in a transmission line.

Measurements

Display Layout	Single screen or split screen display including TDR/DTF, TDR/Return Loss
Distance	5000 Meters
Distance Units	Meters, Feet
TDR Ohm Measurement Range	0 Ω to 5000 Ω
Resolution	0.01 Ω
TDR Linear Measurement Range	0 U to 500 U
Resolution	0.01 U

1. Factory default 1-Port ReadyCal (automatically applied to all measurements), User calibration (User Cal) overrides ReadyCa

Coverage Mapping (Option 431) (Spectrum Analyzer, 5GNR, LTE measurements)**Spectrum Analyzer Measurements**

Channel Power	Plots channel power in dBm, dBW, dBV, dBmV, dB μ V, dBA, V, W, A
Spectral Density	Plots spectral density in dBm/Hz, dBW/Hz, dBV/Hz, dBmV/Hz, dB μ V/Hz, dBA/Hz, V/Hz, W/Hz, A/Hz
RSSI	Plots received signal strength indicator in dBm, dBW, dBV, dBmV, dB μ V, dBA, V, W, A
Field Strength	Plots field strength in dBm/m ² , dBW/m ² , dBV/m, dBmV/m, dB μ V/m, dBA/m, V/m, W/m ² , W/cm ² , A/m ²
Power Flux Density	Plots power flux density in dBm/m ² /Hz, dBW/m ² /Hz, dBV/m/Hz, dBmV/m/Hz, dB μ V/m/Hz, dBA/m/Hz, V/m/Hz, W/m ² /Hz, W/cm ² /Hz, A/m/Hz

Spectrum Analyzer Measurement Setup

Map Type	Indoor: PNG or JPEG Outdoor: OpenStreetMap® (downloaded direct from Internet to instrument or using external PC software)
Frequency (Excluding RSSI)	Center/Start/Stop, Frequency Step, Frequency Offset
Span (Excluding RSSI)	Span (Manual/Increment 1, 2, 5), Full Span, Last Span, Zero Span
Amplitude	Reference Level (Manual/Auto and Offset), Scale/Division, Y-Axis Unit, Preamp (on/off), Attenuation (Auto/Manual), Field Strength, Impedance (50 Ω , 75 Ω , other), Custom IMP Loss
Bandwidth	RBW/VBW (Auto/Manual), VBW Type (Linear/Logarithmic), RBW:VBW Ratio, SPAN:RBW Ratio
Mapping Colors	Customizable Amplitude Range Thresholds for Each Color Blue (Excellent), Green (Very Good), Yellow (Good), Orange (Fair), Pink (Poor)
Point Distance or Time Setup	Repeat Type: Time (1 s to 60 s) or Distance (1 m to 10,000 m), Distance Units: Meters or Feet
Save	Indoor: Setup, Measurement File (fm spa), PNG Outdoor: Setup, KML Points, PNG, Tab Delimited
Recall	Setup, KML Points File, Measurement File (fm spa)

LTE Measurement (Option 883 is required (see [“WCDMA FDD Signal Analyzer \(Option 871\)”](#) on page 14))

Channel Power	Plots channel power in dBm, dBW, dBV, dBmV, dB μ V, dBA
Spectral Density	Plots spectral density in dBm/Hz, dBW/Hz, dBV/Hz, dBmV/Hz, dB μ V/Hz, dBA/Hz
RSRP	Plots received signal strength indicator in dBm, dBW, dBV, dBmV, dB μ V, dBA
RSRQ	Plots received signal strength indicator in dB
SINR	Plots received signal strength indicator in dB

LTE Measurement Setup

Map Type	Indoor: PNG or JPEG Outdoor: OpenStreetMap® (downloaded direct from Internet to instrument or using external PC software)
Frequency	Center Frequency, Channel Bandwidth, EARFCN, Signal Standard
Amplitude	Auto Range (On/Off), Reference Level (Manual/Auto and Offset), Scale/Division, Y-Axis Unit, Preamp (on/off), Attenuation (Auto/Manual)
Bandwidth	RBW/VBW (Auto/Manual), VBW Type (Linear/Logarithmic), RBW:VBW Ratio, SPAN:RBW Ratio
Mapping Colors	Customizable Amplitude Range Thresholds for Each Color Channel Power and Spectral Density: Blue (Excellent), Green (Very Good), Yellow (Good), Orange (Fair), Pink (Poor) RSRP, RSRQ, SINR: Blue (Excellent), Green (Good), Yellow (Poor), Pink (Bad), Gray (No Sync)
Point Distance or Time Setup	Repeat Type: Time (1 s to 60 s) or Distance (1 m to 10,000 m), Distance Units: Meters or Feet
Map Source	Any PCI, Defined PCI, Available PCI Filter, Manual PCI Filter
Save	Indoor: Setup, Measurement File (fm lte), PNG Outdoor: Setup, KML Points, CSV, PNG,
Recall	Setup, KML Points File

5GNR Measurement (Option 888 is required (see [“5GNR FDD/TDD FR1 Signal Analyzer \(Option 888\)”](#) on page 17))

Channel Power	Plots channel power in dBm, dBW, dBV, dBmV, dB μ V, dBA
Spectral Density	Plots spectral density in dBm/Hz, dBW/Hz, dBV/Hz, dBmV/Hz, dB μ V/Hz, dBA/Hz
SS-RSRP	Plots received signal strength indicator in dBm, dBW, dBV, dBmV, dB μ V, dBA
SS-RSRQ	Plots received signal strength indicator in dB
SS-SINR	Plots received signal strength indicator in dB

5GNR Measurement Setup

Map Type	Indoor: PNG or JPEG Outdoor: OpenStreetMap® (downloaded direct from Internet to instrument or using external PC software)
Frequency	Center Frequency, Channel Bandwidth, SSB Frequency, SSB Offset, Auto Detect SSB, Subcarrier Spacing, Mapping Pattern (P1, P2, Auto), Band Config: Band (Manual, Global All), ARFCN, Channel BW, GSCN
Amplitude	Auto Range (On/Off), Reference Level (Manual/Auto and Offset), Scale/Division, Y-Axis Unit, Preamp (on/off), Attenuation (Auto/Manual)
Bandwidth	RBW/VBW (Auto/Manual), VBW Type (Linear/Logarithmic), RBW:VBW Ratio, SPAN:RBW Ratio
Mapping Colors	Customizable Amplitude Range Thresholds for Each Color Channel Power and Spectral Density: Blue (Excellent), Green (Very Good), Yellow (Good), Orange (Fair), Pink (Poor) SS-RSRP, SS-RSRQ, SS-SINR: Blue (Excellent), Green (Good), Yellow (Poor), Pink (Bad), Gray (No Sync)
Point Distance or Time Setup	Repeat Type: Time (1 s to 60 s) or Distance (1 m to 10,000 m), Distance Units: Meters or Feet
Map Source	Any PCI, Defined PCI, Available PCI Filter, Manual PCI Filter
Save	Indoor: Setup, Measurement File (fm5gnr), PNG Outdoor: Setup, KML Points, PNG, CSV
Recall	Setup, KML Points File

Electromagnetic Field (EMF) Measurement (Option 444) (requires a supported antenna, sold separately)

The Spectrum Analyzer mode provides electromagnetic field strength measurements in three axis (X, Y, Z) with trace displays for each measurement and tabular results.

Measurements/Settings

Setup	Limit lines, Axis Dwell Time, Measurement Time, Measurement Count, Measurement Units, Data Logging with storage location
Units	dBm/m^2 , dBW/m^2 , dBV/m , dBmV/m , $\text{dB}\mu\text{V/m}$, V/m , W/m^2 , W/cm^2 , A/m
Results	Maximum, Minimum, and Average of all measurements conducted
Displayed Information	Measurement progress, number of measurements taken, Pass/fail indicators

Frequency Range

Supported Antenna	
2000-1800-R	9 kHz to 300 MHz
2000-1792-R	30 MHz to 3 GHz
2000-1791-R	700 MHz to 6 GHz

AM/FM Modulation Measurement (Option 509) (Spectrum Analyzer, RTSA, IA Spectrum and IA RTSA measurements)

AM Measurements

AM Depth	0% to 100%, $\pm 2\%$ accuracy, typical
AM Bandwidth	20 kHz
AM Standards	Standard AM, Upper/Lower Sideband suppressed carrier
SINAD	0 to 60 dB, nominal based on 1kHz modulating tone
THD	-60 dB, using up to 10 harmonics of 1 kHz modulating tone
Demodulated AM Spectrum	Frequency Scale, 0 to 24 kHz
Audio Time Domain	5 s or auto zoomed
Graphs	Audio Spectrum (Log AM depth percentage vs frequency), RF Spectrum Audio Time Domain (Linear AM depth percentage vs time), Audio Results
Audio Results	Signal Power (dBm), Carrier Frequency, RMS Depth, (Peak-to-peak)/2 Depth, Peak Positive/Peak Negative Depth, SINAD (dB), Upper/Lower AM Depth, THD (dB)
Setup	Demodulation Frequency, Demodulation Marker (on/off), Marker Tracked (1 to 12), Zoomed Time Graph (on/off), Modulation (AM, USB, LSB), Audio (on/off), Volume (on/off), Record Duration (1 to 100000 S), Record, Squelch Level (-120 to 30 dBm)

FM Measurements

FM Bandwidth	96 kHz (wide)
FM Deviation	Up to 75 kHz with 2% accuracy, ± 1 kHz typical
SINAD	0 to 60 dB, nominal based on 1 kHz modulating tone
THD	-75 to 0 dB, using up to 10 harmonics of 1 kHz modulating tone
Demodulated FM Spectrum	Wideband: 96 kHz full span, 20 kHz zoomed Narrowband: 25 kHz, 24 kHz (audio spectrum) 12.5 kHz, 14 kHz (audio spectrum) 6.25 kHz, 6 kHz (audio spectrum)
Audio Time Domain	5 s or auto zoomed
Graphs	Audio Spectrum (Log FM deviation vs frequency), RF Spectrum Audio Time Domain (Linear FM deviation vs time), Audio Results
Audio Results	Signal Power (Hz), Carrier Frequency, Upper/Lower Deviation, RMS FM deviation, (Peak-to-peak)/2 Deviation, SINAD, Total Harmonic Distortion (THD), Left/Right RDS deviation, Pilot Deviation
Setup	Demodulation Frequency, Demodulation Marker (on/off), Marker Tracked (1 to 12), Zoomed Audio Graph (on/off), Zoomed Time Graph (on/off), Modulation (FM Narrowband (6.25, 12.5, 25 kHz), FM Wideband), Audio (on/off), Volume (on/off), Record Duration (1 to 100000 S), Record, Squelch Level (-120 to 30 dBm)

WCDMA FDD Signal Analyzer (Option 871)

General

Frequency Range	10 MHz to 6 GHz (option dependent)
Channel Bandwidth (MHz)	5
Amplitude	Auto Range on/off, Reference Level (Manual/Auto), Scale/Division, Y Axis Unit, Attenuation Level (Auto/Manual), Reference Level Offset, Preamp on/off
Input Signal Range	-80 dBm to +10 dBm
Sweep	Sweep Once/Continuous, Hold (On/Off), Restart Averaging, Gated Sweep (Channel Power and OBW)

WCDMA

Demod Summary View	Sync: Primary Scrambling Code, Code Group, Frequency Error, Time Offset, Status Frequency Error: Count, Average, STD Deviation, Minimum, Maximum
Summary Table View	Carrier Frequency, Frequency error/Average frequency error, Channel Power, Occupied BW, Scrambling Code

WCDMA Adjacent Channel Power

Upper/Lower Measurements	Channel (Main, Adjacent, Alternate) Absolute, Relative, Limit (dBm)
Setup Parameters	Channel Spacing, Main/Adjacent/Alternate Integration Bandwidth, Limit Type (Absolute/Relative), Limits (On/Off), Main/Adjacent/Alternate Channel Limit

WCDMA Channel Power

Measurements	Total Channel Power, Total Power Spectral Density (PSD), Limit Test (CH Power and PSD)
Setup Parameters	Integration Bandwidth, PSD Units (Hz/MHz), Power Limit (dBm), PSD Limit (dBm/Hz)

WCDMA Spectral Emission Mask (SEM)

Measurements	Segment, RBW, Peak Power, Peak Frequency, Mask Name, Reference Channel Power and Channel BW
Setup Parameters	Select Mask, Import Mask, Export Mask, Reference Channel Bandwidth, Auto Max Power (on/off), Manual Max Power

WCDMA Occupied Bandwidth

Measurements	Occupied BW, Total Power, Value, Limit, OBW Center Frequency, Left Edge and Right Edge
Setup Parameters	% OBW Power, X DB, OBW Limit (on/off), Method (percent/X dB)

LTE FDD/TDD Signal Analyzer (Option 883)

General	
Frequency Range	10 MHz to 6 GHz (option dependent)
Channel Bandwidth (MHz)	1.4, 3, 5, 10, 15, 20
Amplitude	Auto Range, Reference Level (Manual/Auto), Scale/Division, Y Axis Unit, Attenuation Level (Auto/Manual), Reference Level Offset, Preamp
Input Signal Range	-76 dBm to +10 dBm
Sweep	Continuous (on/off), Sweep Once, Restart Averaging (Demod Summary only), Hold (on/off)
MIMO Antenna Setup	Auto, Antenna 0, 1, 2, or 3
LTE Demodulation Summary	
PCI Summary Measurements	Physical Cell ID, Sector ID, Cell Group, Frequency Error, Time Offset, Cyclic Prefix, Status of Primary Synchronization Signal (PSS), MIMO Time Alignment Error, Resource Block Power
Signal Power Measurements (dBm)	Physical Broadcast Channel Power (PBCH), Sync Signal (SS), Reference Signal (RS), OFDM Symbol Transmit Power (OSTP)
Error Vector Magnitude Measurements (%)	Physical Broadcast Channel (QPSK), Physical Downlink Shared Channel (QPSK), PDSCH (16-QAM/64-QAM/256-QAM)
Demod Summary View	PCI, Sector ID, Cell Group, Frequency Error, Time Offset, Cyclic Prefix, Sync Status, Power (PBCH, SS, RS), EVM (PBCH(QPSK), PDSCH (QPSK, 16-QAM, 64-QAM, 256-QAM), Average EVM, Peak EVM
Time Alignment Error (TAE) View	PCI, Sector ID, Cell Group, Frequency Error, Time Offset, Cyclic Prefix, Sync Status, TAE between each antenna pair, Power (RS, SS), EVM (RMS, PEAK)
Resource Block (RB) Power View	PCI, Sector ID, Cell Group, Frequency Error, Time Offset, Cyclic Prefix, Sync Status, RB (number of active RBs, Utilization, OSTP), EVM (QPSK, 16-QAM, 64-QAM, 256-QAM)
Summary Table View	Carrier Frequency, Frequency error, Channel Power, RS Power, Occupied BW and Physical Cell ID
Setup Parameters	Integration Bandwidth (Summary Table view only), Antenna (Auto/1/2/3/4), Cyclic Prefix (Auto/Normal/Extended), Duplex Type (FDD/TDD), UL/DL Config (TDD only), CFI (Auto/CFI1/CFI2/CFI3), DSS Detect (on/off), SSB Offset, Frequency Error Type (Summary Table view only): Current, Average, Auto Detect SSB
RS Power Accuracy	±1.0 dB typical (RF input -50 dBm to +10 dBm)
Frequency Error	±10 Hz + time base error (99 % confidence level)
Residual EVM (rms)	2.0 % typical (E-UTRA Test Model 3.1, RF Input -50 dBm to +10 dBm)
LTE DSS Detection	
Setup Parameters	DSS Detect (On/Off), Status, PCI, Beam, SS-RSRP
LTE Multi PCI	
Measurements	Multiple Physical Cell IDs, Secondary Sync Signal Power (S-SS), Reference Signal Received Power (RSRP), Reference Signal Received Quality (RSRQ), Signal to Interference and Noise Ratio (SINR), Average Error Vector Magnitude (EVM), Peak EVM, Frequency Error (Hz and PPM), Dominance (dB)
Graph Displays	PCI, SINR, RSRP, RSRQ, SS Power
Setup Parameters	Cyclic Prefix (Auto/Normal/Extended), Duplex Type (FDD/TDD), UL/DL Config (TDD only), CFI (Auto/CFI1/CFI2/CFI3), DSS Detect On/Off (Status, PCI, Beam, SS-RSRP), SSB Offset, Auto Detect SSB
LTE Channel Power	
Measurements	Total Channel Power, Total Power Spectral Density (PSD), Limit Test (Power and PSD)
Setup Parameters	Integration Bandwidth, PSD Units (Hz/MHz), Power Limit (dBm), PSD Limit (dBm/Hz)
RF Channel Power Accuracy	±1 dB typical (-50 dBm to +10 dBm)
LTE Channel Spectrum	
Measurements	Occupied Bandwidth (OBW), Total Power, Reference Signal (RS), Frequency Error, Limit Test (OBW)
Setup Parameters	% OBW Power (%/dB), XdB, OBW Limit (on/off) (Hz), Method (percent (%), x dB)
LTE Carrier Aggregation	
Measurements	Carrier, Physical-layer Cell ID (PCI), RSRP, RSRQ, SINR, EVM (% RMS), Frequency Error (Hz), Bandwidth (BW), Center Frequency, Antennas
Setup Parameters	Carrier, Carrier Count (up to eight), Antenna (Auto/0/1/2/3), Cyclic Prefix (Auto/Normal/Extended), Duplex Type (FDD/TDD)
LTE Control Channel	
PCI Summary Measurements	Physical Cell ID, Sector ID, Cell Group, Frequency Error, Time Offset, Cyclic Prefix, Status of Primary Synchronization Signal (PSS)
Power Measurements	Reference Signal (RS), P-Primary Synchronization Signal (P-SS), Secondary Synchronization Signal (S-SS), Physical Broadcast Channel (PBCH), Physical Control Format Indicator Channel (PCFICH), Physical Hybrid Automatic Repeat Request Indicator Channel (PHICH), Physical Downlink Control Channel (PDCCH), Total Power per Resource Element and Power (dBm/watts), EVM (%)
Setup Parameters	Antenna (Auto/0/1/2/3), Cyclic Prefix (Auto/Normal/Extended), Duplex Type (FDD/TDD), UL/DL Config (TDD only), NG (1/6, 1/2, 1, 2), CFI (Auto/CFI1/CFI2/CFI3)
LTE Adjacent Channel Power	
Upper/Lower Measurements	Channel (Main, Adjacent, Alternate) Absolute, Relative, Limit (dBm)
Setup Parameters	Channel Spacing, Main/Adjacent/Alternate Integration Bandwidth, Limit Type (Absolute/Relative), Limits (On/Off), Main/Adjacent/Alternate Channel Limit

LTE Spectral Emission Mask (SEM)

Measurements	Segment, RBW, Peak Power, Peak Frequency, Mask Name, Reference Channel Power and Channel BW
Setup Parameters	Select Mask, Import Mask, Export Mask, Reference Channel Bandwidth, Auto Max Power (on/off), Manual Max Power

LTE Constellation

Measurements	Physical Cell ID, Sector ID, Cell Group, Frequency Error, Time Offset, Cyclic Prefix, Status of Primary Synchronization Signal (PSS), Constellation Display of PBCH or PDSCH
Power Measurements	Reference Signal (RS) Power, P-Primary Synchronization Signal (P-SS) Power, Secondary Synchronization Signal (S-SS) power, RMS EVM (%), Peak RMS, Physical Downlink Started Channel (PDSCH), QPSK, 16-QAM, 64-QAM, 256-QAM
Setup Parameters	Antenna (Auto/0/1/2/3), Cyclic Prefix (Auto/Normal/Extended), Duplex Type (FDD/TDD), UL/DL Config (TDD only), CFI (Auto/CFI1/CFI2/CFI3), Data Select (PBCH/PDSCH), Modulation (All/QPSK/16-QAM/64-QAM/256-QAM), Ref Points

LTE UL/DL Interference

Display	Frame/Subframe power against time plus gated uplink or downlink RF spectrum on single screen
Measurements	Physical Cell ID, Sector ID, Cell Group, Frequency Error, Time Offset, Cyclic Prefix, Status of Primary Synchronization Signal (PSS)
Sub-Frame Power Measurements	Sub-Frame, Slot (0 and 1), Total Frame Power, Uplink and Downlink Pilot Time Slots (DwPTS and UpPTS), and Transmit Off Power
Setup Parameters	Analysis (Frame/Subframe/Slot), SSF Config (Auto/0-9/Invalid), Sub-Frame (0-9), Slot (0/1) Antenna (Auto/0/1/2/3), Gated Spec Type (Uplink, Downlink, Guard Period, All, None), Gated Duration (Frame, Coupled), Time Level Offset, Frame Start Time (Auto, Sync Once, UTC, Custom), Frame Time Offset, Cyclic Prefix (Auto/Normal/Extended), Duplex Type (FDD/TDD), UL/DL Config (TDD only), NG (1/6, 1/2, 1, 2)

5G NR FDD/TDD FR1 Signal Analyzer (Option 888)

General

Frequency Range	10 MHz to 6 GHz (option dependent)
Band Configuration	Manual, Global All or selectable Band #, Absolute Radio Frequency Channel Number (ARFCN), Global Synchronization Raster Channel (GSCN), Channel Bandwidth (5 MHz to 100 MHz in steps of 5 MHz), SSB Offset, Subcarrier Spacing (15, 30, 120, 240 kHz), Mapping Pattern (Auto, P1, P2), Auto SSB Detect
Auto SSB Detect	Searches 3GPP defined GSCN raster
Amplitude	Auto Range, Reference Level, Scale/Division, Y Axis Unit, Reference Level Offset, Attenuation Level (Auto/Manual), Preamp
Input Signal Range	-76 dBm to +10 dBm
Sweep	Continuous (on/off), Sweep Once, Restart Averaging (5G NR Summary only), Hold (on/off)

5G NR Summary

Multi-Beam Measurements	Physical-layer Cell ID, Beam Index, Sector ID, Cell Group, Frequency Error, Time Offset (µs), Status, SS-RSRP (dBm), SS-RSRQ (dB), SS-SINR (dB), SS-RSSI (dB), Sync and Demod Status Indicators
Single-Beam Measurements	Physical Cell ID, Sector ID, Cell Group, Frequency Error, Time Offset, Status, Count, Average, Standard Deviation, Minimum, Maximum, SS-RSRP (dBm), SS-RSRQ (dB), SS-SINR (dB), SS-RSSI, Sync and Demod Status Indicators, Block Measurements (PSS, SSS, PBCH, PBCH-DMRS), Average EVM, Peak EVM (@ subcarrier/symbol), Beam Power (dBm)
Summary Table View	Carrier Frequency, Frequency Error, Channel Power, SS-RSRP, Occupied BW, Physical Cell ID, Sync and Demod Status Indicators
Views	Multi Beam (up to 64), Single Beam, Summary Table
Setup Parameters	Integration Bandwidth (Summary Table view only), SINR Threshold (dB), Duplex Type (FDD/TDD), GMC Offset (µs), Distance to Antenna (m), Distance Unit (m/ft), Frequency Error Type (Summary Table view only): Current, Average
RSRP Accuracy	± 1.0 dB typical
Residual EVM (rms)	2.0 % typical
Frequency Error	< ± 4.0E-9 + time base error, typical (FR1, Channel BW ≤ 50 MHz) < ± 5.0E-9 + time base error, typical (FR1, Channel BW > 50 MHz) < ± 1.0E-8 + time base error, typical (FR2)

5G NR OTA (Multi PCI)

Measurements	Multiple Physical-layer Cell (PCI) IDs, Beam Index, SS-RSRP (dBm), SS-RSRQ (dB), SS-SINR (dB), SS-RSSI (dB) SS-EVM (%), Time Offset (µs), Sync Status Indicator
Views	Multi PCI Beam Scanner (up to 64 beams), Table, Time Offset Table
Setup Parameters	SINR Threshold (dB), Duplex Type (FDD/TDD)

5G NR RF EIRP

Measurements	EIRP (Active, Horizontal/Vertical, Sum), Upper/Lower Limit Test
Views	Normal (RF spectrum), Quick View (summary)
Setup Parameters	Save (Horizontal/Vertical), Reset Sum, RX Antenna Gain, Distance to Antenna, Distance Unit (Meters/Feet), Upper/Lower Limit Test, RX Cable Loss (dB)

5G NR RF Occupied Bandwidth

Measurements	Occupied Bandwidth, Total Power, Limit Test
Setup Parameters	Method (% or X dB), % OBW Power, OBW Limit (On/Off), X dB

5G NR RF Channel Power

Measurements	Total Channel Power, Total PSD, Limit Test
Setup Parameters	Integration Bandwidth, PSD Units (Hz and MHz), Power Limit (On/Off), PSD Limit (On/Off)
RF Channel Power Accuracy	±1 dB typical (-76 dBm to +10 dBm)

5G NR Carrier Aggregation

Component Carriers	Up to Eight Component Carriers
PCI Measurements	Carrier, Sync status (PSS), Physical-layer Cell ID (PCI), Center Frequency, Bandwidth (BW), RSRP Max, EVM (RMS), Frequency Error (Hz), Time Offset
Setup Parameters	Carrier, Carrier Count (up to 8), Duplex Type (FDD/TDD)

5G NR Constellation

Measurements	Beam, PBCH-DMRS Power, PSS Power, SSS Power, RMS EVM, Peak EVM
PCI Measurements	Physical Cell ID, Sector ID, Cell Group, Frequency Error, Time Offset, Status
Setup Parameters	Modulation (QPSK), Data Select (PBCH), Beam Select, Reference Points (on/off)

5G NR Spectral Emission Mask (supported in normal spectrum analyzer mode)

Measurements	Segment, RBW, Peak PWR, Peak Freq
Setup Parameters	Select Mask, Import Mask, Export Mask, REF CH BW, Auto Max PWR, Manual Max PWR

5G NR Adjacent Channel Power (supported in normal spectrum analyzer mode)

Measurements	Channel, Absolute, Relative, Limit
Setup Parameters	Channel Spacing, Main Integ BW, ADJ Integ BW, ALT Integ BW, Limit Type, Limits, Main CH Limit, ADJ CH Limit, ALT CH Limit

5G NR UL/DL Interference

Display	Frame/Subframe power against time plus gated uplink or downlink RF spectrum on single screen
Measurements	Physical Cell ID, Sector ID, Cell Group, Frequency Error, Time Offset, Status of Primary Synchronization Signal (PSS), Total Frame Power
Sub-Frame Power Measurements	Sub-Frame, Slot (0 and 1)
Setup Parameters	Analysis (Frame/Subframe/Slot), Sub-Frame (0-9), Slot (0 to 15), Gated Spec Type (Uplink, Downlink, Flexible, All, None), Gated Duration (Frame, Coupled), Time Level Offset, Frame Start Time (Auto, Sync Once, UTC, UTC+3 ms, UTC-2 ms, Custom), Frame Time offset, Frame Structure (A/B1/B2/Custom), Special Slot Type (Type 1/2), Frame Setup (Frame Structure, Pattern Number, Uplink Slots Pattern 1/2, Downlink Slots Pattern 1/2, Uplink Symbols Pattern 1/2, Downlink Symbols Pattern 1/2, Trans Periodicity Pattern 1/2), Cyclic Prefix (Normal), Duplex Type (FDD/TDD)

General Specifications**Setup Parameters**

Display	Brightness adjustment, Auto screen dimming shutoff timer (on/off), Color schemes (Default, Light, Black on White, Night Vision), Shortcuts (Hide Shortcuts On/Off)
Sound	System Volume (Mute All On/Off), Defaults
Date and Time	Date and Time settings (Automatic, Manual), Time Zone settings, Time synced to Internet/GNSS
Language	English, Spanish, Chinese-simplified, Japanese, French, Korean
Screenshot	Capture Region (Graphs Only, Entire Application), Color (Printable, Standard), Annotations (Header, Footer) File naming (Automatic Timestamp, Manual), Directory
Options	Installed Options, Available Options, Install Options from web, Enable options using file (USB)), Save Config
GNSS (GPS)	See " GNSS Receiver (Option 31) " on page 8
Ethernet	Ethernet (IP4 & IP6 formats), Type (DHCP, Static IP)
WLAN (Wi-Fi)	2x2 MIMO, 802.11 a/b/g/n/ac, On/Off, Auto detect wireless networks
Port Setup	Bias Voltage On/Off, Voltage, Info
Maps	Tile Usage
Advanced	RF Safe Mode on/off, SCPI Errors on/off, Share Center Frequency on/off, Remote Lock on/off, Set Remote Password, Add Custom Certificate, Save Public Key and Certificate Information
Instrument Memory	8 GB of which nominally 1.5 GB is allocated to the operating system. Available memory to users is nominally 6.5 GB. Available memory is accessed by user saving of: screen images, trace files, setup files, digital maps, IQ captures, audio files and report files.

File Menu

Save/Recall	Measurement Setup, Screenshot Image (.PNG), Export Measurement data (Text, CSV), Location
File Management	Save, Copy, Paste, Delete, Create New Folder, Set File Name and File Type, Rename

Diagnostics Menu

Battery Information, Event Log (Export File), Self Test, Service (Enable Service Mode)

Tools Menu

Web, IQ Streaming, Map Tool, PDF Reports

Report Generator

PDF Reports	Creates detailed measurement reports on the instrument
Report Contents	Free form text fields to identify and locate the site of measurements, company logo image, Cable and Antenna analyzer trace files, instrument screen captures and site photographs
Report Format	PDF and HTML

Connectors

RF In	Type N(f), 50 Ω
GPS	SMA(f)
External Power	5.5 mm barrel connector, 14 to 16 VDC, 5.0 A max
Ethernet Interface	RJ45 connector for Ethernet 10/100/1000 Mbps (connect to PC or LAN for remote access)
USB Interface	Two USB 3 Type A (supports file transfer) One USB 3 Type C (USBTMC)
Headset Jack	3.5 mm headset jack
External Reference In	SMA(f), 50 Ω
External Trigger In	SMA(f), 50 Ω , TTL-compatible levels
DC Bias Voltage	SMA(f), Setup: On/Off, Voltage, Trip Reset Voltage Range: +1 V to +34 V, Resolution: 0.1 V

Display and Keyboard

Display	10.1-inches capacitive touchscreen, 1280 x 800 resolution
Shortcuts	Maximum of five user-configured measurement setup shortcuts
Screen Strength	IK08 (protected against a five joule impact)
Keyboard	Common alphanumeric/symbolic keys and customizable EZ keyboard
Touch Gestures	Pinch to zoom x (span), Drag in x (center frequency, markers, limit line points)
Titlebar	System menu, application menu, camera icon, USB eject icon, software update icon, local host icon, lock status (touchscreen), notification icon, Wi-Fi icon, Theme Icon, GNSS icon, battery percentage icon, time and date

Battery

Type	Li-ion
Battery Life	3 hours operation, typical ¹
Charging Temperature Limit	0 °C to +45 °C, relative humidity ≤ 80 %
Nominal Capacity	8400 mAh
Nominal Energy	94 Wh
External Battery Accessory	6 hours operation, typical (with an accessory battery contained in soft carrying case)

Regulatory Compliance

European Union	EMC 2014/30/EU, EN 61326-1:2013 CISPR 11/EN 55011, IEC/EN 61000-4-2/3/4/5/6/8/11 Low Voltage Directive 2014/35/EU Safety EN 61010-1:2010 RoHS Directive 2011/65/EU & 2015/863
United Kingdom	EMC SI 2016/1091; BS EN 55011 & BS 61000-4-2/3/4/5/6/8/11 Consumer Protection (Safety) SI 2016/1101; BS EN 61010-1:2010 Environmental Protection SI 2012/3032;2011/65/EU & 2015/863
Australia and New Zealand	RCM AS/NZS 4417:2012
South Korea	KCC-R-R-A2J-1002
Canada	ICES-3(A)/NMB-3(A)
United States	FCC ID: SQG-60SIPT

Environmental

	MIL-PRF-28800F Class 2
Operating Temperature Range	-10°C to 55°C
Storage Temperature Range	-51°C to 71°C
Maximum Relative Humidity	95 % RH at 30°C, non-condensing
Vibration, Sinusoidal	5 Hz to 55 Hz
Vibration, Random	10 Hz to 500 Hz
Half Sine Shock	30 g _n
Altitude	4600 meters, operating and non-operating
Explosive Atmosphere	MIL-PRF-28800F Section 4.5.6.3 MIL-STD-810G, Method 511.5, Procedure 1
Ingress Protection Rating	Complies with IP52 when installed in soft carrying case

Warranty

Duration	Standard three-year warranty One-year warranty on battery
----------	--

Size and Weight

Size	290 mm x 212 mm x 96 mm (11.4 in x 8.3 in x 3.7 in)
Weight	MS2080A-0704, -0706: 3.8 kg (8.39 lb)

Programmable Remote Control

Functionality	Full instrument programming control (except power On/Off) via Ethernet and Wi-Fi, and USBTMC. See the Programming Manual for details.
Programming Language	Standard Commands for Programmable Instruments (SCPI)
Interfaces	Ethernet, WLAN, USBTMC (USB C port) 90 days warranty

1. 633-75 (84 Wh) 2.5 hours operation, typical, SPA with an accessory battery - 5.5 hours operation, typical.

Anritsu Remote and Report Tools (ARRT) (for your PC)

Anritsu Report Tool

Supported Measurements	Return Loss, 1-Port Phase, VSWR, DTF Return Loss, DTF VSWR, Cable Loss, Smith Chart, TDR Ohm, TDR Linear, Transmission (USB Sensor)
Markers	8 regular Markers, 7 Delta markers Marker Functions: Distance/Frequency, Mode (Reference, Delta, Normal) Marker Search: Peak, Valley, Marker between
Limits	Limit File: Load, Save Limit Functions: Mode (Single, Segmented), Upper Limit, Lower Limit, Upper Level, Lower Level, Segmented Limit Functions: Segment (42 segmented limits are supported), Segment Type (Upper/Lower), Add Segment, Delete Segment, Clear All, X1, X2, Y1, Y2 and Y Offset
Save	.limcaa,.fmcaausb files
Report Generator	Config: Load Template, Save Template, Clear Template, Report Folder, Report Name, Black & White Graphs, Title, Site Information, Site Location, Company Logo, Logo Alignment, Work Order Number, Technician ID, Prepared By, Approved By Setup: Measurement traces per page (1 to 4) Preview: Open PDF preview in browser
Cable List Tool	Cable List: Allows selection of predefined cables User Cable List: Allows creation of custom cable list
Trace Selection	Enables selection of a specific trace from the list in title bar
Trace Pop-out	Enables opening of a trace in a new window
Theme	Dark, Light
Settings	Report Config, Instrument, Help, About
Connections	Connect to instrument using Ethernet or Wi-Fi
Download	Use Anritsu Remote Tool to download measurements, live traces and limit files to PC for storage and analysis using Anritsu Report Tool
Upload	Upload measurements from PC to instrument

Anritsu Remote Tool

Functionality	Free Anritsu Remote and Report Tools software download from www.anritsu.com Full instrument graphical user interface control from a PC with simulated hardware support for on-screen measurement analysis ARRT software compatible with Windows® 10 and 11; 32 or 64 bit operating systems
Interfaces	Ethernet, WLAN

Ordering Information – Instrument Options

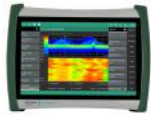

Part Number Description

MS2080A Field Master Spectrum Analyzer (Requires Option 704 or 706)

Options

- MS2080A-0704 9 kHz to 4 GHz Spectrum Analyzer
- MS2080A-0706 9 kHz to 6 GHz Spectrum Analyzer
- MS2080A-0003* Time Domain Reflectometry (TDR) Measurement (Requires S331P, sold separately)
- MS2080A-0017 Secure Communication
- MS2080A-0019* High Accuracy Power Meter (Requires USB power sensor, sold separately)
- MS2080A-0024* Interference Finder (Option 31 and directional antenna recommended, sold separately)
- MS2080A-0027* Channel Scanner
- MS2080A-0031* GNSS Receiver (requires GNSS antenna, sold separately)
- MS2080A-0090* Gated Sweep
- MS2080A-0102* 40 MHz Analysis Bandwidth
- MS2080A-0126* IQ Waveform Capture (Includes MX280005A IQ Signal Master base feature set)
- MS2080A-0127* IQ Waveform Streaming (Includes MX280005A IQ Signal Master base feature set) (Requires Option 126)
- MS2080A-0128* Enable Vector Signal Analysis (Requires Option 126)
- MS2080A-0199* Real-time Spectrum Analysis (RTSA)
- MS2080A-0400* Enable Vision Monitor
- MS2080A-0407* Enable Vision High-Speed Port Scanner
- MS2080A-0431* Coverage Mapping (Requires Option 31, cannot be ordered with Option 9031)
- MS2080A-0444* EMF Measurement (Requires Anritsu isotropic antenna, sold separately)
- MS2080A-0509* AM/FM Modulation Measurements
- MS2080A-0871* WCDMA FDD Measurements (Requires Option 31)
- MS2080A-0883* LTE FDD/TDD Measurements (Requires Option 31)
- MS2080A-0888* 5G NR Downlink Measurements (Requires Option 31)
- MS2080A-xxxx-0097 Accredited Calibration to ISO17025 and ANSI/NCSL Z540-1 (xxxx is the frequency option number)
- MS2080A-xxxx-0098 Standard Calibration to ISO17025 and ANSI/NCSL Z540-1 (xxxx is the frequency option number)
- MS2080A-xxxx-0099 Premium Calibration to ISO17025 and ANSI/NCSL Z540-1 plus test data (xxxx is the frequency option number)

*** Time-Limited Options** Options marked with an asterisk are offered as a 90-day time limited option by ordering as a -9xxx series option. For example, MS2080A-9888 is the 90-day time limited option for 5GNR FDD/TDD FR1 Measurements. The option start time begins when the user first activates the option.

Supported PC Software

- MX280001A Vision™ Monitor
- MX280005A IQ Signal Master™ Vector Modulation Analysis
- MX280007A Mobile InterferenceHunter™
- ARRT Anritsu Remote and Report Tools

Standard Accessories (included with instrument)

Accessory	Description
	2000-2071-R MS2080A Soft Case
	Certificate of Calibration and Conformance
	633-79 Li-ion Battery, 94Wh
	2000-2156-R SMA(m) to BNC(f) Adapter (qty 3)





Accessory	Description
	2000-1371-R Ethernet Cable, 2 m
	2000-1859-R USB Cable, USB 3.0 Type-A to Type-C, 1 m
	806-442-R SMA(m) to BNC(m) cable, 1 m
	633-75 Li-Ion Battery, 84Wh

Related Manuals (available at www.anritsu.com)

Part Number	Description
10100-00069	Product Information, Compliance, and Safety
10580-00483	Field Master User Guide
10580-00484	Field Master Programming Manual
10580-00447	Spectrum Analyzer Measurement Guide Interference Finder (Option 24, requires Option 31) Gated Sweep (Option 90) Coverage Mapping (Option 431) AM/FM Modulation Measurement (Option 509)
10580-00448	RTSA Measurement Guide (Option 199)Interference Finder (Option 24, requires Option 31)
10580-00449	5GNR Measurement Guide (Option 888) Gated Sweep (Option 90) Coverage Mapping (Option 431, requires Option 31)
10580-00450	LTE Measurement Guide (Option 883) Gated Sweep (Option 90) Coverage Mapping (Option 431)
10580-00492	High Accuracy Power Meter Measurement Guide (Option 19)
10580-00493	Cable and Antenna Analyzer Measurement Guide (Option 331)
10580-00501	WCDMA Measurement Guide (Option 871)
10580-00504	Channel Scanner Measurement Guide (Option 27)

USB Power Sensors and S331P Site Master Cable and Antenna Analyzer (for complete ordering information, see the respective data sheets of each sensor)

Accessory	Description
	MA24330A Microwave CW USB Power Sensor, 10 MHz to 33 GHz, +20 dBm
	MA24340A Microwave CW USB Power Sensor, 10 MHz to 40 GHz, +20 dBm
	MA24350A Microwave CW USB Power Sensor, 10 MHz to 50 GHz, +20 dBm
	MA24208A Microwave Universal USB Power Sensor, 10 MHz to 8 GHz, +20 dBm to -60 dBm
	MA24218A Microwave Universal USB Power Sensor, 10 MHz to 18 GHz, +20 dBm to -60 dBm
	MA24106A High Accuracy RF Power Sensor, 50 MHz to 6 GHz, +23 dBm to -40 dBm



Accessory	Description
	MA24108A Microwave USB Power Sensor, 10 MHz to 8 GHz, +20 dBm to -40 dBm
	MA24118A Microwave USB Power Sensor, 10 MHz to 18 GHz, +20 dBm to -40 dBm
	MA24126A Microwave USB Power Sensor, 10 MHz to 26 GHz, +20 dBm to -40 dBm
	S331P Ultraportable Cable & Antenna Analyzer 150 kHz to 4 GHz or 6 GHz
	MA25100A RF Power Indicator

Optional Accessories

Miscellaneous Accessories		Accessory	Description
	67135 Anritsu Backpack (for Handheld Instrument and PC)		760-243-R Large Transit Case with Wheels and Handle 56 cm x 45.5 cm x 26.5 cm (22.07" x 17.92" x 10.42")
	760-271-R Transit Case (For Portable Directional Antennas and Port Extender P/N 2000-1777-R, 2000-1778-R, 2000-1779-R and 2000-1798-R) (Case can contain all loop antennas at once)		2000-1374-R External Dual Charger for Li-Ion Batteries
	2000-2048-R Screen Protector		2000-2074-R Extended Power Pack with Cable
	760-261-R Large transit case (for instrument, MA2700A, Yagi/Log Periodic antennas plus minor cables and accessories)		2000-2053-R Shoulder Harness
	2000-2149-R EMI Near-Field Probe Kit, 100 kHz to 1 GHz Requires 1092-172-R Type N to BNC Adapter and 1 m BNC to BNC Cable (sold separately) (For full specifications, refer to the Near-Field Probe Set User Guide 10580-00347)		2000-1884-R PIM Hunter™ Test Probe (For full specifications, refer to the 2000-1884-R Technical Data Sheet 11410-00999)
	12N50-75B Matching Pad, DC to 3 GHz, 50 Ω to 75 Ω		2000-2146-R Bias tee, 2.5 MHz to 6 GHz
	2000-2150-R Universal Field Master Rack Mount Kit		

USB Extender Kit (for use with external USB sensors; requires Cat 5e extension cable, sold separately)

Accessory	Description
	2000-1900-R USB 2.0 Active 100 meter Extender (with Type A power cord for USA, Japan, North America, Central America and Caribbean)
	2000-1901-R USB 2.0 Active 100 meter Extender (with Type C power cord for use in Europe, India, South Korea, and many countries in Middle East and Africa)
	2000-1902-R USB 2.0 Active 100 meter Extender (with Type I power cord for use in Australia, New Zealand, Argentina, and the South Pacific)
	2000-1903-R USB 2.0 Active 100 meter Extender (with Type G power cord for use in the UK, and several other countries in Asia, the Middle East, and Africa)



Accessory	Description
	2000-1717-R USB 1.1 Passive 40 m Extender (Not compatible with sensors MA24208A, MA24218A, MA24330A, MA24340A, MA24350A; must use active extenders with these sensors).
	2100-28-R Cat 5e extension cable for use with USB Extender (22.5 m)



Coaxial Calibration Components, 50 Ω

Accessory	Description
	OSLN50A-8 High Performance Type N(m), DC to 8 GHz, 50 Ω
	OSLNF50A-8 High Performance Type N(f), DC to 8 GHz, 50 Ω
	2000-1914-R Precision Open/Short/Load, 4.3-10(f), DC to 6 GHz, 50 Ω
	2000-1915-R Precision Open/Short/Load, 4.3-10(m), DC to 6 GHz, 50 Ω
	2000-1618-R Precision Open/Short/Load, 7/16 DIN(m), DC to 6.0 GHz 50 Ω
	ICN51A InstaCal™ Calibration Module, 40 dB typical 9 kHz to 6 GHz, N(m), 50 Ω



Accessory	Description
	2000-1619-R Precision Open/Short/Load, 7/16 DIN(f), DC to 6.0 GHz 50 Ω
	22N50 Open/Short, N(m), DC to 18 GHz, 50 Ω
	22NF50 Open/Short, N(f), DC to 18 GHz, 50 Ω
	SM/PL-1 Precision Load, N(m), 42 dB, 6.0 GHz
	SM/PLNF-1 Precision Load, N(f), 42 dB, 6.0 GHz

Coaxial Calibration Components, 75 Ω

Accessory	Description
	22N75 Open/Short, N(m), DC to 3 GHz, 75 Ω
	26N75A Precision Termination, N(m), DC to 3 GHz, 75 Ω

Accessory	Description
	22NF75 Open/Short, N(f), DC to 3 GHz, 75 Ω
	26NF75A Precision Termination, N(f), DC to 3 GHz, 75 Ω

GPS Antennas (active)

Accessory	Description
	2000-1528-R Magnet Mount, SMA (m) with 5 m (16.4 ft) cable, requires 5 VDC
	2000-1652-R Magnet Mount, SMA (m) with 0.3 m (1 ft) cable, requires 3.3 VDC or 5 VDC

Accessory	Description
	2000-1760-R Miniature Antenna, SMA (m), requires 2.5 VDC to 3.7 VDC

Portable Antennas

Accessory	Description
	2000-1200-R 806 MHz to 866 MHz, SMA(m), 50 Ω
	2000-1473-R 870 MHz to 960 MHz, SMA(m), 50 Ω
	2000-1035-R 896 MHz to 941 MHz, SMA(m), 50 Ω (1/2 wave)
	2000-1030-R 1710 MHz to 1880 MHz, SMA(m), 50 Ω (1/2 wave)
	2000-1474-R 1710 MHz to 1880 MHz with knuckle elbow (1/2 wave)
	2000-1031-R 1850 MHz to 1990 MHz, SMA(m), 50 Ω (1/2 wave)







Accessory	Description
	2000-1475-R 1920 MHz to 1980 MHz and 2110 MHz to 2170 MHz, SMA(m), 50 Ω
	2000-1032-R 2400 MHz to 2500 MHz, SMA(m), 50 Ω (1/2 wave)
	2000-1751-R 698 MHz to 960 MHz, 1710 MHz to 2100 MHz, 2500 MHz to 2700 MHz, SMA(m), 2 dB, typical, 50 Ω
	2000-1361-R 2400 MHz to 2500 MHz, 5000 MHz to 6000 MHz, SMA(m), 50 Ω
	2000-1636-R Antenna Kit (Consists of: 2000-1030-R, 2000-1031-R, 2000-1032-R, 2000-1200-R, 2000-1035-R, 2000-1361-R, and carrying pouch)

Mag Mount and Broadband Antennas

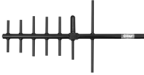
Accessory	Description
	2000-2141-R 20 MHz to 21000 MHz, N(f), 50 Ω
	2000-1645-R 694 MHz to 894 MHz, 3 dBi peak gain 1700 MHz to 2700 MHz, 3 dBi peak gain, N(m), 50 Ω, 10 ft
	2000-1646-R 750 MHz to 1250 MHz, 3 dBi peak gain, 1650 MHz to 2000 MHz, 5 dBi peak gain, 2100 MHz to 2700 MHz, 5 dBi peak gain, N(m), 50 Ω, 10 ft

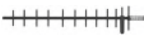

Accessory	Description
	2000-1648-R 1700 MHz to 6000 MHz, 3 dBi peak gain, N(m), 50 Ω, 10 ft
	2000-1946-R Cable 1: 617 MHz to 960 MHz, 3 dBi peak gain, 1710 MHz to 3700 MHz, 4 dBi peak gain, N(m), 50 Ω, 10 ft Cable 2: 3000 MHz to 6000 MHz, 5 dBi peak gain, N(m), 50 Ω, 10 ft Cable 3: GPS 26 dB gain, SMA(m), 50 Ω, 10 ft
	2000-1647-R Cable 1: 698 MHz to 1200 MHz, 2 dBi peak gain, 1700 MHz to 2700 MHz, 5 dBi peak gain, N(m), 50 Ω, 10 ft Cable 2: 3000 MHz to 6000 MHz, 5 dBi peak gain, N(m), 50 Ω, 10 ft Cable 3: GPS 26 dB gain, SMA(m), 50 Ω, 10 ft

Directional Antennas

Accessory	Description
	2000-1411-R 824 MHz to 896 MHz, N(f), 12.3 dBi, Yagi
	2000-1412-R 885 MHz to 975 MHz, N(f), 12.6 dBi, Yagi
	2000-1413-R 1710 MHz to 1880 MHz, N(f), 12.3 dBi, Yagi
	2000-1414-R 1850 MHz to 1990 MHz, N(f), 11.4 dBi, Yagi
	2000-1415-R 2400 MHz to 2500 MHz, N(f), 14.1 dBi, Yagi
	2000-1416-R 1920 MHz to 2170 MHz, N(f), 14.3 dBi, Yagi
	2000-1659-R 698 MHz to 787 MHz, N(f), 10.1 dBi, Yagi
	2000-1660-R 1425 MHz to 1535 MHz, N(f), 14.3 dBi, Yagi



Accessory	Description
	2000-1726-R 2500 MHz to 2700 MHz, N(f), 14.1 dBi, Yagi
	2000-2107-R Log Periodic, 20 MHz to 8.5 GHz (requires Port Extender 2000-1798-R or bandpass filter when used with MA2700A)
	2000-1748-R Log Periodic, 1 GHz to 18 GHz, N(f), 6 dBi, typical
	2000-1777-R 9 kHz to 20 MHz, N(f) (requires port extender 2000-1798-R when used with MA2700A)
	2000-1778-R 20 MHz to 200 MHz, N(f) (requires port extender 2000-1798-R when used with MA2700A)
	2000-1779-R 200 MHz to 500 MHz, N(f) (requires port extender 2000-1798-R when used with MA2700A)
	2000-1812-R Portable Yagi Antenna, 450 MHz to 512 MHz, N(f), 7.1 dBi
	2000-1825-R Portable Yagi Antenna, 380 MHz to 430 MHz, N(f), 7.1 dBi



InterferenceHunter™ and Accessories

Accessory	Description
	MA2700A Handheld Interference Hunter (For full specifications, refer to the MA2700A Technical Data Sheet 11410-00692)
	2000-1735-R 776 MHz to 788 MHz, N(m) and N(f), 50 Ω
	2000-1736-R 815 MHz to 850 MHz, N(m) and N(f), 50 Ω
	2000-1737-R 1711 MHz to 1756 MHz, N(m) and N(f), 50 Ω
	2000-1738-R 1850 MHz to 1910 MHz, N(m) and N(f), 50 Ω
	2000-1739-R 880 MHz to 915 MHz, N(m) and N(f), 50 Ω
	2000-1740-R 1710 MHz to 1785 MHz, N(m) and N(f), 50 Ω

Accessory	Description
	2000-1734-R 699 MHz to 715 MHz, N(m) and N(f), 50 Ω
	2000-1741-R 1920 MHz to 1980 MHz, N(m) and N(f), 50 Ω
	2000-1742-R 832 MHz to 862 MHz, N(m) and N(f), 50 Ω
	2000-1743-R 2500 MHz to 2570 MHz, N(m) and N(f), 50 Ω
	2000-1798-R Port Extender, DC to 6 GHz
	2000-1799-R 2305 MHz to 2320 MHz, N(m) and N(f), 50 Ω
	2000-2147-R 3700 MHz to 3980 MHz, N(m) to N(f), 50 Ω

EMF Antennas/Probes

Accessory	Description
	2000-1800-R Isotropic Antenna, H-Field, 9 kHz to 300 MHz
	2000-1792-R Isotropic Antenna, E-Field, 30 MHz to 3 GHz

Accessory	Description
	2000-1791-R Isotropic Antenna, E-Field, 0.7 GHz to 6 GHz
	2000-1985-R EMF Probe, 20 MHz to 40 GHz

Bandpass Filters		Accessory	Description
	1030-114-R 806 MHz to 869 MHz, N(m) to SMA(f), 50 Ω		2000-1684-R 791 MHz to 821 MHz, N(m) to N(f), 50 Ω
	1030-109-R 824 MHz to 849 MHz, N(m) to SMA(f), 50 Ω		
	1030-110-R 880 MHz to 915 MHz, N(m) to SMA(f), 50 Ω		
	1030-111-R 1850 MHz to 1910 MHz, N(m) to SMA(f), 50 Ω		
	1030-112-R 2400 MHz to 2484 MHz, N(m) to SMA(f), 50 Ω		
	1030-105-R 890 MHz to 915 MHz, N(m) to N(f), 50 Ω		
	1030-106-R 1710 MHz to 1790 MHz, N(m) to N(f), 50 Ω		
	1030-107-R 1910 MHz to 1990 MHz, N(m) to N(f), 50 Ω		
	1030-149-R High Pass, 150 MHz, N(m) to N(f), 50 Ω		
	1030-150-R High Pass, 400 MHz, N(m) to N(f), 50 Ω		
	1030-151-R High Pass, 700 MHz, N(m) to N(f), 50 Ω		
	1030-152-R Low Pass, 200 MHz, N(m) to N(f), 50 Ω		
	1030-153-R Low Pass, 550 MHz, N(m) to N(f), 50 Ω		
	1030-155-R 2500 MHz to 2700 MHz, N(m) to N(f), 50 Ω		
	1030-178-R 1920 MHz to 1980 MHz, N(m) to N(f), 50 Ω		
	1030-179-R 777 MHz to 798 MHz, N(m) to N(f), 50 Ω		
	1030-180-R 2500 MHz to 2570 MHz, N(m) to N(f), 50 Ω		

Adapters	
Accessory	Description
	1091-26-R SMA(m) to N(m), DC to 18 GHz, 50 Ω
	1091-27-R SMA(f) to N(m), DC to 18 GHz, 50 Ω
	1091-80-R SMA(m) to N(f), DC to 18 GHz, 50 Ω
	1091-81-R SMA(f) to N(f), DC to 18 GHz, 50 Ω
	1091-172-R BNC(f) to N(m), DC to 1.3 GHz, 50 Ω
	1091-417-R N(m) to QMA(f), DC to 6 GHz, 50 Ω
	1091-418-R N(m) to QMA(m), DC to 18 GHz, 50 Ω
Precision Adapters	
Accessory	Description
	34NN50A N(m) to N(m), DC to 18 GHz, 50 Ω

Accessory	Description
	510-102-R N(m) to N(m), DC to 11 GHz, 50 Ω, 90 degrees right angle
	510-90-R 7/16 DIN(f) to N(m), DC to 7.5 GHz, 50 Ω
	510-91-R 7/16 DIN(f) to N(f), DC to 7.5 GHz, 50 Ω
	510-92-R 7/16 DIN(m) to N(m), DC to 7.5 GHz, 50 Ω
	510-93-R 7/16 DIN(m) to N(f), DC to 7.5 GHz, 50 Ω
	510-96-R 7/16 DIN(m) to 7/16 DIN(m), DC to 7.5 GHz, 50 Ω
	510-97-R 7/16 DIN(f) to 7/16 DIN(f), DC to 7.5 GHz, 50 Ω
Accessory	Description
	34NFN50 N(f) to N(f), DC to 18 GHz, 50 Ω

Attenuators

Accessory	Description
	1010-121-R 40 dB, 100 W, DC to 18 GHz, N(f) to N(m), Uni-directional
	3-1010-122 20 dB, 5 W, DC to 12.4 GHz, N(m) to N(f)
	3-1010-123 30 dB, 50 W, DC to 8.5 GHz, N(m) to N(f)
	3-1010-124 40 dB, 100 W, DC to 8.5 GHz, N(f) to N(m), Uni-directional

Accessory Description

Accessory	Description
	42N50-20 20 dB, 5 W, DC to 18 GHz, N(m) to N(f)
	42N50A-30 30 dB, 50 W, DC to 18 GHz, N(m) to N(f)
	1010-127-R 30 dB, 150 W, DC to 3 GHz, N(m) to N(f)
	1010-128-R 40 dB, 150 W, DC to 3 GHz, N(m) to N(f)



+1 (888) 880-6804
sales@testforce.com

Training at Anritsu

Anritsu has designed courses to help you stay up to date with technologies important to your job. For available training courses, visit: <https://www.anritsu.com>, and search for training and education.



• United States

Anritsu Americas Sales Company

490 Jarvis Drive, Morgan Hill, CA 95037-2809, U.S.A.
Phone: +1-800-Anritsu (1-800-267-4878)

• Canada

Anritsu Electronics Ltd.

Americas Sales and Support

490 Jarvis Drive, Morgan Hill, CA 95037-2809, U.S.A.
Phone: +1-800-Anritsu (1-800-267-4878)

• Brazil

Anritsu Eletronica Ltda.

Praça Amadeu Amaral, 27 - 1 Andar
01327-010 - Bela Vista - Sao Paulo - SP, Brazil
Phone: +55-11-3283-2511
Fax: +55-11-3288-6940

• Mexico

Anritsu Company, S.A. de C.V.

Blvd Miguel de Cervantes Saavedra #169 Piso 1,
Col. Granada, Mexico, Ciudad de Mexico,
11520, MEXICO
Phone: +52-55-4169-7104

• United Kingdom

Anritsu EMEA Ltd.

200 Capability Green,
Luton, Bedfordshire, LU1 3LU, U.K.
Phone: +44-1582-433200
Fax: +44-1582-731303

• France

Anritsu S.A.

12 avenue du Québec, Immeuble Goyave,
91140 VILLEBON SUR YVETTE, France
Phone: +33-1-60-92-15-50

• Germany

Anritsu GmbH

Nemetschek Haus, Konrad-Zuse-Platz 1,
81829 München, Germany
Phone: +49-89-442308-0
Fax: +49-89-442308-55

• Italy

Anritsu S.r.l.

Spaces Eur Arte, Viale dell'Arte 25, 00144 Roma, Italy
Phone: +39-6-509-9711

• Sweden

Anritsu AB

Kistagången 20 B, 2 tr, 164 40 Kista, Sweden
Phone: +46-8-534-707-00

• Finland

Anritsu AB

Technopolis Aviapolis, Teknobulevardi 3-5 (D208.5),
FI-01530 Vantaa, Finland
Phone: +358-20-741-8100

• Denmark

Anritsu A/S

c/o Regus Winghouse, Ørestads Boulevard 73, 4th
floor,
2300 Copenhagen S, Denmark
Phone: +45-7211-2200

• Spain

Anritsu EMEA Ltd.

Representation Office in Spain

Paseo de la Castellana, 141.
Planta 5, Edificio Cuzco IV
28046, Madrid, Spain
Phone: +34-91-572-6761

• Austria

Anritsu EMEA GmbH

Am Belvedere 10, A-1100 Vienna, Austria
Phone: +43-(0)1-717-28-710

• United Arab Emirates

Anritsu EMEA Ltd.

Anritsu A/S

Office No. 164, Building 17, Dubai Internet City
P. O. Box – 501901, Dubai, United Arab Emirates
Phone: +971-4-3758479

• India

Anritsu India Private Limited

6th Floor, Indiqueb ETA, No.38/4, Adjacent to EMC2,
Doddanekundi, Outer Ring Road,
Bengaluru – 560048, India
Phone: +91-80-6728-1300
Fax: +91-80-6728-1301

• Singapore

Anritsu Pte. Ltd.

1 Jalan Kilang Timor, #07-04/06 Pacific Tech Centre
Singapore 159303
Phone: +65-6282-2400
Fax: +65-6282-2533

• Vietnam

Anritsu Company Limited

16th Floor, Peakview Tower, 36 Hoang Cau Street,
O Cho Dua Ward, Dong Da District, Hanoi, Vietnam
Phone: +84-24-3201-2730

• P.R. China (Shanghai)

Anritsu (China) Co., Ltd.

Room 2701-2705, Tower A, New Caohejing
International Business Center No. 391 Gui Ping Road
Shanghai, 200233, P.R. China
Phone: +86-21-6237-0898
Fax: +86-21-6237-0899

• P.R. China (Hong Kong)

Anritsu Company Ltd.

Unit 1006-7, 10/F., Greenfield Tower, Concordia Plaza,
No. 1 Science Museum Road, Tsim Sha Tsui East,
Kowloon, Hong Kong, P.R. China
Phone: +852-2301-4980
Fax: +852-2301-3545

• Japan

Anritsu Corporation

8-5, Tamura-cho, Atsugi-shi, Kanagawa, 243-0016
Japan
Phone: +81-46-296-6509
Fax: +81-46-225-8352

• South Korea

Anritsu Corporation, Ltd.

8F, A TOWER, 20, Gwacheondaero 7-gil, Gwacheon-si,
Gyeonggi-do, 13840, Republic of Korea
Phone: +82-2-6259-7300
Fax: +82-2-6259-7301

• Australia

Anritsu Pty. Ltd.

Unit 20, 21-35 Ricketts Road,
Mount Waverley, Victoria 3149, Australia
Phone: +61-3-9558-8177
Fax: +61-3-9558-8255

• Taiwan

Anritsu Company Inc.

7F, No. 316, Sec. 1, NeiHu Rd., Taipei 114, Taiwan
Phone: +886-2-8751-1816
Fax: +886-2-8751-1817

List Revision Date: 20240416