

4200-SCS

Semiconductor Characterization System Technical Data



4200-SPEC Rev. M

Model 4200-SCS Technical Data

SEMICONDUCTOR

1.888.KEITHLEY (U.S. only)

www.keithley.com

KEITHLEY

A GREATER MEASURE OF CONFIDENCE

4200-SCS

- 2 Introduction
- 4 Configuration Options
- 6 Hardware Specifications
- 13 KTE Interactive Software Tools
 - 13 Microsoft Windows
 - 14 The Keithley Interactive Test Environment (KITE)
 - 22 Keithley User Library Tool (KULT)
 - 23 System Configuration and Diagnostics (KCON)
 - 23 Keithley External Control Interface (KXCI)
- 23 Support Contracts
- 24 Value-Add Services
- 24 Other Upgrades
- 25 Embedded PC Policy
- 25 Warranty Information
- 26 Switch Matrix Support and Configurations
- 28 Accessories and Optional Instrumentation
- 29 Other Optional Accessories

Semiconductor Characterization System Technical Data

Introduction

The Model 4200-SCS is a total system solution for electrical characterization of devices, materials and semiconductor processes. This advanced parameter analyzer provides intuitive and sophisticated capabilities for semiconductor device characterization by combining unprecedented measurement sensitivity and accuracy with an embedded Windows®-based operating system and the Keithley Interactive Test Environment. It is a powerful single box solution.

To get a complete picture of any device or material, three fundamental electrical measurement techniques are required. The Model 4200-SCS offers all three.

- Precision DC Current-Voltage (I-V) measurements are the foundation of a full characterization plan.
- AC Impedance, including the well known Capacitance-Voltage (C-V) technique, provides information beyond what DC alone can provide.
- Pulsed and transient testing adds a time domain dimension and allows for dynamic characteristics to be explored.

The 4200-SCS is modular, configurable and upgradeable. This allows it to precisely meet today's measurement needs and to expand to meet tomorrow's. Four core measurement modules can be mixed and matched in the nine instrument slots.

- Up to nine precision DC Source-Measure units can supply voltage or current and measure voltage or current from 0.1fA to 1A and from 1 μ V to 210V.
- AC Impedance testing is easy with the Model 4210-CVU Multi-Frequency C-V Module, at test frequencies from 1kHz to 10MHz. Capacitance from aF to μ F can be measured.
- Pulse and transient measurements can be performed with the Model 4225-PMU Ultra-Fast I-V module. This module has two independent voltage sources that can slew the voltage at 1V/ns while simultaneously measuring both the voltage and the current. When multiple modules are installed, they are internally synchronized to less than 3ns.
- A choice of two different digital oscilloscope modules makes digitizing waveforms easy and efficient.

The Keithley Interactive Test Environment (KITE) supplies a complete, graphical user interface that allows nearly any type of characterization test to be performed with no programming required. Over 400 standard characterization tests are provided, including those for: MOSFETs, BJT transistors, diodes, resistors, capacitors, solar cells, carbon nanotubes, and NVM memory technologies such as Flash, RRAM, PCRAM, and others. Data is stored in industry standard spreadsheet formats. Any measured or calculated data can be graphed in KITE's sophisticated, report-ready graphing tool.

1.888.KEITHLEY (U.S. only)

www.keithley.com

KEITHLEY

A GREATER MEASURE OF CONFIDENCE

4200-SCS

Semiconductor Characterization System Technical Data

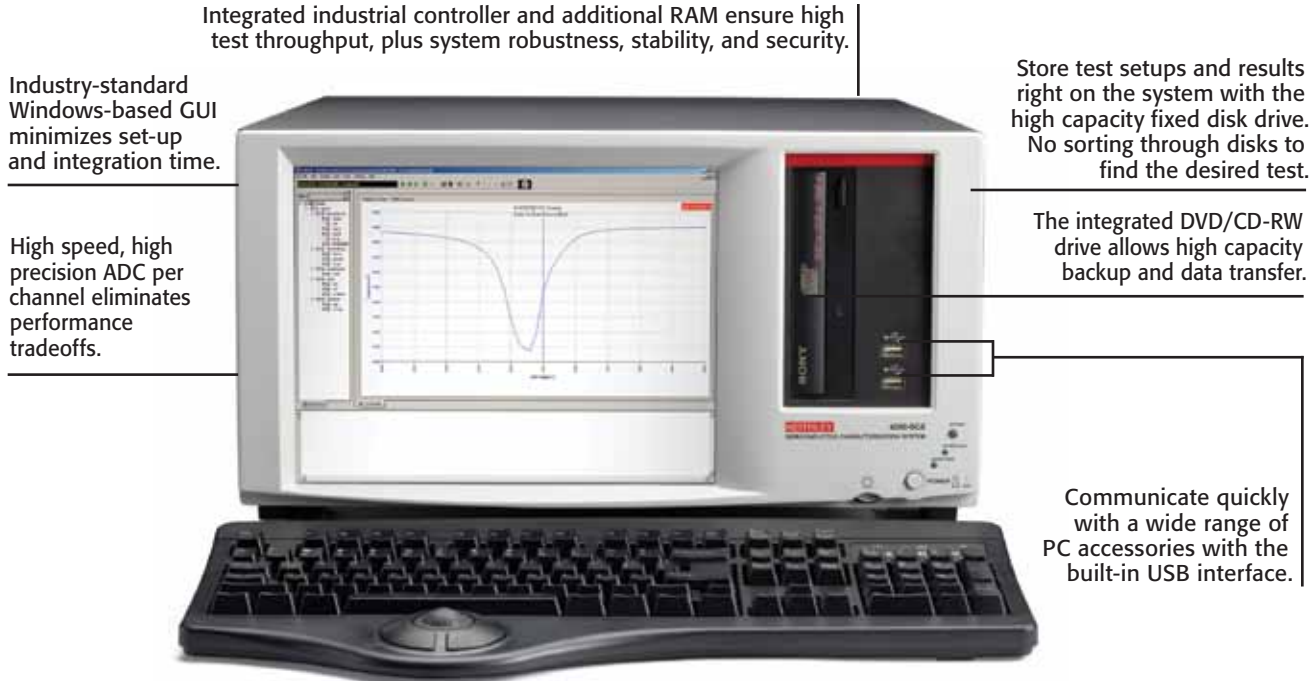

Integrated industrial controller and additional RAM ensure high test throughput, plus system robustness, stability, and security.

Industry-standard Windows-based GUI minimizes set-up and integration time.

High speed, high precision ADC per channel eliminates performance tradeoffs.

Store test setups and results right on the system with the high capacity fixed disk drive. No sorting through disks to find the desired test.

The integrated DVD/CD-RW drive allows high capacity backup and data transfer.

Communicate quickly with a wide range of PC accessories with the built-in USB interface.

The 4200-SCS can be rack mounted. It has the same dimensions and occupies the same rack space as semiconductor parametric analyzers that may already be in use.

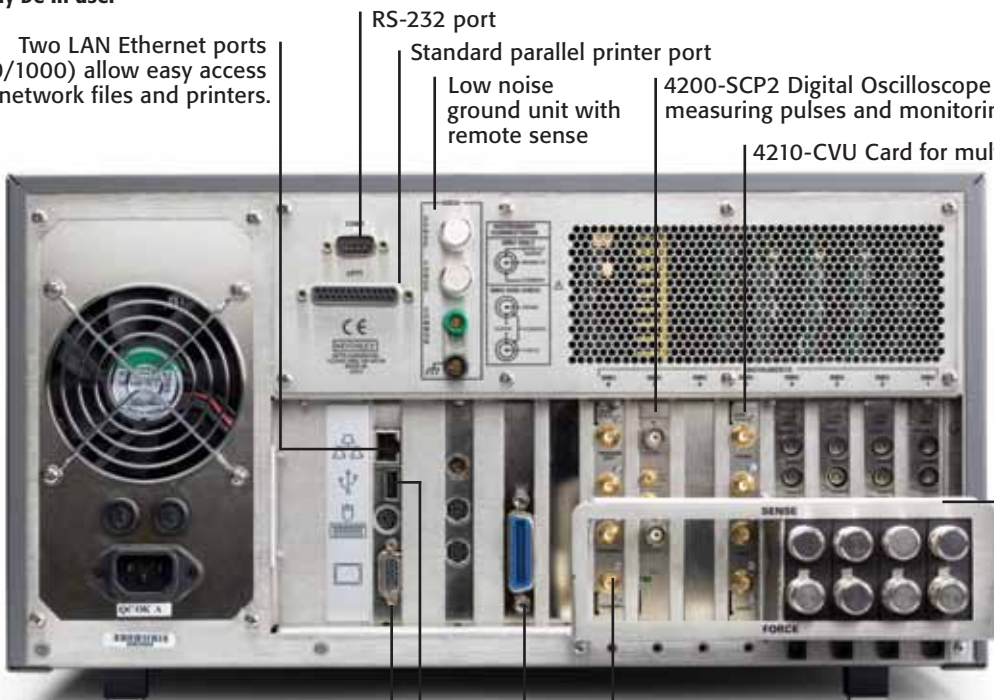

Two LAN Ethernet ports (10/100/1000) allow easy access to network files and printers.

RS-232 port

Standard parallel printer port

Low noise ground unit with remote sense

4200-SCP2 Digital Oscilloscope for measuring pulses and monitoring waveforms

4210-CVU Card for multi-frequency C-V testing

Configurable with from two to nine SMUs and optional sub-femtoamp Remote PreAmps. Adding high power SMUs won't restrict SMU capacity.

SVGA monitor port

Additional USB port

Dual-channel ultra-fast I-V module supports pulse I-V testing and other pulse applications.

Use the GPIB interface to control external instruments or to allow external control of the 4200-SCS.

1.888.KEITHLEY (U.S. only)

www.keithley.com

KEITHLEY

A GREATER MEASURE OF CONFIDENCE

4200-SCS

Semiconductor Characterization System Technical Data

Configuration Options

The 4200-SCS supports many instrument configurations that can include SMUs, C-V measurement units, ultra-fast I-V modules, pulse generators, and oscilloscopes. The standard configuration includes two medium power Source-Measure Units (SMUs) and a Ground Unit.

Standard 4200-SCS Models

4200-SCS/F	9 slot chassis with integrated controller 12.1" flat panel display Two (2) Model 4200-SMU medium power SMUs One (1) Remote Sense Ground Unit LAN, GPIB, USB, RS-232, parallel port, hard disk, DVD/CD-RW
4200-SCS/C	9 slot chassis with integrated controller Composite Front Bezel (i.e., no built-in display) Two (2) Model 4200-SMU medium power SMUs One (1) Remote Sense Ground Unit LAN, GPIB, USB, RS-232, parallel port, hard disk, DVD/CD-RW

Source-Measure Units

Each system can be configured with up to seven additional SMUs, for a total of nine SMUs. Two SMU models are available: a medium power (100mA, 2W) version (Model 4200-SMU) and a high power (1A, 20W) version (Model 4210-SMU). The system can support up to nine high power SMUs.

4200-SCS Source-Measure Units

	MAXIMUM VOLTAGE	MAXIMUM CURRENT	MAXIMUM POWER
4200-SMU (medium power)	210V	100mA	2W
4210-SMU (high power)	210V	1A	20W

Remote PreAmp

The low current measurement capabilities of any SMU can be extended by adding an optional Remote PreAmp (Model 4200-PA). The 4200-PA provides 0.1fA resolution by effectively adding five current ranges to either SMU model. The PreAmp module is fully integrated with the system; to the user, the SMU simply appears to have additional measurement resolution available. The Remote PreAmp is shipped installed on the back panel of the 4200-SCS for local operation. This installation allows for standard cabling to a prober, test fixture, or switch matrix. Users can remove the PreAmp from the back panel and place it in a remote location (such as in a light-tight enclosure or on the prober platen) to eliminate measurement problems due to long cables. Platen mounts and triax panel mount accessories are available.

Remote PreAmps are installed at the factory in numerical order, i.e., SMU1, SMU2, SMU3 ... up to the number of PreAmps specified.

Capacitance-Voltage Instrument

C-V measurements are now as easy to perform as I-V measurements with the integrated C-V instrument, the Model 4210-CVU. This optional capacitance-voltage instrument performs capacitance measurements from femtofarads (fF) to microfarads (μ F) at frequencies from 1kHz to 10MHz. It also supplies diagnostic tools that ensure the validity of your C-V test results.

With this system, you can configure linear or custom C-V, C-f, and C-t sweeps with up to 4096 data points. In addition, through the open environment of the 4200-SCS, you can modify any of the included tests.

Ultra-Fast I-V Module

Perform ultra-fast (transient) I-V measurements with the Model 4225-PMU. It provides ultra-fast voltage waveform generation and signal observation on its two channels of integrated sourcing and measurement. Each channel combines high speed voltage outputs (including pulse widths from 60ns to DC) with simultaneous current and voltage measurements at a sample rate of up to 200 megasamples/second.

Pulse Generator

The Model 4220-PGU Dual-Channel Pulse Generator provides dual-channel pulsing with voltage pulses as high as 40V and down to 20ns pulse width. In addition to the pulse capability, the 4200-PGU offers linear, arbitrary waveform (ARB), and segment ARB™ (patent pending) sweeps.

Remote Amplifier/Switch

The low current measurement capability of the Model 4225-PMU can be extended by adding the optional Model 4225-RPM Remote Amplifier/Switch. The RPM effectively adds three lower current ranges to any channel of the 4225-PMU Ultra-Fast I-V module. The RPM is fully integrated into the system software, so to the user it simply looks like three additional low current ranges. Additionally, the RPM acts as a multiplexer switch, allowing users to automatically switch between precision DC SMUs, the CVU, or the Ultra-Fast I-V modules.

Oscilloscope

The system supports two dual-channel integrated digital oscilloscope options: the Model 4200-SCP2 offers 8-bit resolution with a sample rate up to 2.5 gigasamples/second, while the Model 4200-SCP2HR provides 16-bit resolution and a sample rate up to 400 megasamples/second. Both can be programmed for automated measurement and data acquisition or used with the stand-alone GUI application provided to perform traditional oscilloscope tasks. They provide measurements in both the time (frequency, rise/fall time) and voltage domains (amplitude, peak-peak, etc.).

1.888.KEITHLEY (U.S. only)

www.keithley.com

KEITHLEY

A GREATER MEASURE OF CONFIDENCE

Configuration Examples

The 4200-SCS's plug-in chassis design offers exceptional configuration flexibility, as the following examples illustrate. A chassis can contain up to nine SMUs in any combination of high and medium powered units. Any configuration can be specified without a flat panel display by substituting the 4200-SCS/C for the 4200-SCS/F. However, an external SVGA monitor is required to operate the 4200-SCS/C.

Basic Characterization System Configuration

Configuration:	One (1) Model 4200-SCS/F Three (3) Model 4200-SMU medium power SMUs One (1) Model 4200-PA Remote PreAmp module One (1) Remote Sense Ground Unit
Description:	A general-purpose configuration for characterizing transistors and other devices.

Maximum DC Configuration

Configuration:	One (1) Model 4200-SCS/F (includes two medium power SMUs as the standard configuration, which can be substituted with two high power SMUs) Seven (7) additional Model 4210-SMUs (total of nine; all nine can be high power SMUs) Nine (9) Model 4200-PA Remote PreAmp modules
Description:	Provides a nine-SMU system with 0.1fA sensitivity on all nine SMUs and 1A capability on all nine SMUs.

Maximum Pulse Configuration

Configuration:	One (1) Model 4200-SCS/F Four (4) Model 4225-PMU Ultra-Fast I-V modules (8 channels) Note: More than four Model 4225-PMUs may be configured at reduced power levels. Contact Keithley for details. Four (4) Model 4200-SMUs Four (4) Model 4200-PA Remote PreAmp modules
Description:	Provides a four-SMU system with four Model 4225-PMUs that provide eight channels that support traditional pulse mode, arbitrary waveform mode (ARB), Segment ARB™ waveform mode (Segment ARB or SARB), and trigger-in. Each pulse channel contains an inline High Endurance Output Relay (solid-state relay).

Example Broad Use Case Configuration

Configuration:	One (1) Model 4200-SCS/F Two (2) Model 4225-PMU Ultra-Fast I-V modules (4 channels) Two (2) Model 4225-RPM Remote Amplifier/Switches Two (2) Model 4200-SMU Medium Power SMUs Two (2) Model 4210-SMU High Power SMUs Four (4) Model 4200-PA Remote PreAmp modules One (1) Model 4210-CVU Capacitance-Voltage Instrument
Description:	Provides an ultra-flexible multi-use system for a broad range of parametric tests, including very low-level DC measurements, C-V, and ultra-fast I-V for pulse and transient tests.

4200-SCS

Semiconductor Characterization System Technical Data

Hardware Specifications DC SMU Hardware Specifications

CURRENT SPECIFICATIONS

	CURRENT RANGE ¹	MAX. VOLTAGE	MEASURE		SOURCE	
			RESOLUTION ³	ACCURACY ±(% rdg + amps)	RESOLUTION ³	ACCURACY ±(% rdg + amps)
4210-SMU² High Power SMU	1 A	21 V	1 μA	0.100% + 200 μA	50 μA	0.100% + 350 μA
	100 mA	210 V	100 nA	0.045% + 3 μA	5 μA	0.050% + 15 μA
	10 mA	21 V	100 nA	0.045% + 3 μA	5 μA	0.050% + 15 μA
	1 mA	210 V	1 nA	0.035% + 30 nA	50 nA	0.040% + 150 nA
	100 μA	210 V	100 pA	0.033% + 3 nA	5 nA	0.038% + 15 nA
	10 μA	210 V	10 pA	0.050% + 600 pA	500 pA	0.060% + 1.5 nA
	1 μA	210 V	1 pA	0.050% + 100 pA	50 pA	0.060% + 200 pA
4200-SMU and 4210-SMU with optional 4200-PA PreAmp	10 nA	210 V	10 fA	0.050% + 1 pA	500 fA	0.060% + 3 pA
	1 nA	210 V	3 fA	0.050% + 100 fA	50 fA	0.060% + 300 fA
	100 pA	210 V	1 fA	0.100% + 30 fA	15 fA	0.100% + 80 fA
	10 pA	210 V	0.3 fA	0.500% + 15 fA	5 fA	0.500% + 50 fA
	1 pA	210 V	100 aA	1.000% + 10 fA	1.5 fA	1.000% + 40 fA

VOLTAGE COMPLIANCE: Bipolar limits set with a single value between full scale and 10% of selected voltage range.

SPECIFICATION CONDITIONS

Specifications are the performance standards against which the Models 4200-SMU, 4210-SMU, and 4200-PA are tested. The measurement and source accuracy are specified at the termination of the supplied cables.

- 23°C ±5°C, within 1 year of calibration, RH between 5% and 60%, after 30 minutes of warm-up.
- Speed set to NORMAL.
- Guarded Kelvin connection.
- ±1°C and 24 hours from ACAL.

VOLTAGE SPECIFICATIONS

VOLTAGE RANGE ¹	MAX. CURRENT		MEASURE		SOURCE	
	4200-SMU	4210-SMU	Resolution ³	Accuracy ±(% rdg + volts)	Resolution ³	Accuracy ±(% rdg + volts)
200 V ⁺	10.5 mA	105 mA	200 μV	0.015% + 3 mV	5 mV	0.02% + 15 mV
20 V	105 mA	1.05 A	20 μV	0.01% + 1 mV	500 μV	0.02% + 1.5 mV
2 V	105 mA	1.05 A	2 μV	0.012% + 150 μV	50 μV	0.02% + 300 μV
200 mV	105 mA	1.05 A	1 μV	0.012% + 100 μV	5 μV	0.02% + 150 μV

CURRENT COMPLIANCE: Bipolar limits set with a single value between full scale and 10% of selected current range.

Supplemental Information

Supplemental information is not warranted but provides useful information about the Models 4200-SMU, 4210-SMU, and 4200-PA.

COMPLIANCE ACCURACY:

Voltage compliance equals the voltage source specifications.
Current compliance equals the current source specifications.

OVERSHOOT: <0.1% typical.

Voltage: Full scale step, resistive load, and 10mA range.
Current: 1mA step, R_L = 10kΩ, 20V range.

RANGE CHANGE TRANSIENT:

Voltage Ranging: <200mV.
Current Ranging: <200mV.

ACCURACY SPECIFICATIONS: Accuracy specifications are multiplied by one of the following factors, depending upon the ambient temperature and humidity.

Temperature	% Relative Humidity	
	5–60	60–80
10°–18°C	×3	×3
18°–28°C	×1	×3
28°–40°C	×3	×5

REMOTE SENSE: <10Ω in series with FORCE terminal not to exceed a 5V difference between FORCE and SENSE terminals. ±30V maximum between COMMON and SENSE LO.

MAXIMUM LOAD CAPACITANCE: 10nF.

MAXIMUM GUARD OFFSET VOLTAGE: 3mV from FORCE.

GUARD OUTPUT IMPEDANCE: 100kΩ.

MAXIMUM GUARD CAPACITANCE: 1500pF.

MAXIMUM SHIELD CAPACITANCE: 3300pF.

4200-SMU and 4210-SMU SHUNT RESISTANCE (FORCE to COMMON): >10¹²Ω (100nA–1μA ranges).

4200-PA SHUNT RESISTANCE (FORCE to COMMON): >10¹⁶Ω (1pA and 10pA ranges), >10¹³Ω (100pA–100nA ranges).

OUTPUT TERMINAL CONNECTION: Dual triaxial connectors for 4200-PA, dual mini-triaxial connectors for 4200-SMU and 4210-SMU.

NOISE CHARACTERISTICS (typical):

Voltage Source (rms): 0.01% of output range.
Current Source (rms): 0.1% of output range.
Voltage Measure (p-p): 0.02% of measurement range.
Current Measure (p-p): 0.2% of measurement range.

MAXIMUM SLEW RATE: 0.2V/μs.

1.888.KEITHLEY (U.S. only)

www.keithley.com

KEITHLEY

A GREATER MEASURE OF CONFIDENCE

Additional DC SMU Specifications

MAX. OUTPUT POWER: 22 watts for 4210-SMU and 2.2 watts for 4200-SMU (both are four-quadrant source/sink operation).

DC FLOATING VOLTAGE: COMMON can be floated ± 32 volts from chassis ground.

VOLTAGE MONITOR (SMU in VMU mode):

Voltage Range	Measure Resolution	Measure Accuracy \pm (%rdg + volts)
200 V	200 μ V	0.015% + 3 mV
20 V	20 μ V	0.01% + 1 mV
2 V	2 μ V	0.012% + 110 μ V
200 mV	1 μ V	0.012% + 80 μ V

INPUT IMPEDANCE: $>10^{13}\Omega$.

INPUT LEAKAGE CURRENT: <30 pA.

MEASUREMENT NOISE: 0.02% of measurement range (rms).

DIFFERENTIAL VOLTAGE MONITOR:

Differential Voltage Monitor is available by measuring with two SMUs in VMU mode or by using the low sense terminal provided with each SMU.

GROUND UNIT

Voltage error when using the ground unit is included in the 4200-SMU, 4210-SMU, and 4200-PA specifications. No additional errors are introduced when using the ground unit.

OUTPUT TERMINAL CONNECTION: Dual triaxial, 5-way binding post.

MAXIMUM CURRENT: 2.6A using dual triaxial connection; 9.5A using 5-way binding posts.

LOAD CAPACITANCE: No limit.

CABLE RESISTANCE: FORCE $\leq 1\Omega$, SENSE $\leq 10\Omega$.

RAMP RATE QUASISTATIC C-V TYPICAL PERFORMANCE CHARACTERISTICS

MEASUREMENT PARAMETERS: Cp, DCV, timestamp.

RANGING: 1pF to 1nF.

Measurement Terminals: Triaxial guarded.

Ramp Rate: 0.1V/s to 1V/s.

DC Voltage: ± 200 V.

TYPICAL CP ACCURACY: 5% at 1V/s ramp rate.

GENERAL

TEMPERATURE RANGE

Operating: $+10^{\circ}$ to $+40^{\circ}$ C.

Storage: -15° to $+60^{\circ}$ C.

HUMIDITY RANGE

Operating: 5% to 80% RH, non-condensing.

Storage: 5% to 90% RH, non-condensing.

ALTITUDE

Operating: 0 to 2000m.

Storage: 0 to 4600m.

POWER REQUIREMENTS: 100V to 240V, 50 to 60Hz.

MAXIMUM VA: 1000VA.

REGULATORY COMPLIANCE:

Safety: European Low Voltage Directive.

EMC: European EMC Directive.

DIMENSIONS: 43.6cm wide \times 22.3cm high \times 56.5cm deep (17 $\frac{1}{2}$ in \times 8 $\frac{3}{4}$ in \times 22 $\frac{1}{4}$ in).

WEIGHT (approx.): 29.7kg (65.5 lbs) for typical configuration of four SMUs.

I/O PORTS: USB, SVGA, Printer, RS-232, GPIB, Ethernet, Mouse, Keyboard.

NOTES

- All ranges extend to 105% of full scale.
- Specifications apply on these ranges with or without a 4200-PA.
- Specified resolution is limited by fundamental noise limits. Measured resolution is 6 $\frac{1}{2}$ digits on each range. Source resolution is 4 $\frac{1}{2}$ digits on each range.
- Interlock must be engaged to use the 200V range.

4200-SCS

Semiconductor Characterization System Technical Data

Model 4210-CVU Specifications

MEASUREMENT FUNCTIONS

MEASUREMENT PARAMETERS: Cp-G, Cp-D, Cs-Rs, Cs-D, R-jX, Z-theta.

RANGING: Auto and fixed.

MEASUREMENT TERMINAL CONFIGURATION:
Four-terminal pair.

CONNECTOR TYPE: Four SMA (female) connectors.

CABLE LENGTH: 0m, 1.5m, 3m, or custom selectable.

INTEGRATION TIME: FAST, NORMAL, QUIET, and CUSTOM.

TEST SIGNAL

FREQUENCY RANGE: 1kHz to 10MHz.

MINIMUM RESOLUTION: 1kHz, 10kHz, 100kHz, 1MHz
depending on frequency range.

SOURCE FREQUENCY ACCURACY: $\pm 0.1\%$.

SIGNAL OUTPUT LEVEL RANGE: 10mV rms to 100mV rms.

RESOLUTION: 1mV rms.

ACCURACY: $\pm(10.0\% + 1\text{mV rms})$ unloaded (at rear panel).

OUTPUT IMPEDANCE: 100 Ω , typical.

DC BIAS FUNCTION

DC VOLTAGE BIAS:

Range: $\pm 30\text{V}$ ($\pm 60\text{V}$ differential).

Resolution: 1.0mV.

Accuracy: $\pm(0.5\% + 5.0\text{mV})$ unloaded.

MAXIMUM DC CURRENT: 10mA.

SWEEP CHARACTERISTICS

AVAILABLE SWEEP PARAMETERS: DC bias voltage, frequency,
AC voltage.

SWEEP TYPE: Linear, custom.

SWEEP DIRECTION: Up sweep, down sweep.

NUMBER OF MEASUREMENT POINTS: 4096.

EXAMPLE OF INCLUDED LIBRARIES

- C-V, C-t, and C-f measurements and analysis of:
 - High and low κ structures
 - MOSFETs
 - BJTs
 - Diodes
 - III-V compound devices
 - Carbon nanotube (CNT) devices
- Doping profiles, T_{OX} , and carrier lifetime tests
- Junction, pin-to-pin, and interconnect capacitance measurements
- Solar cells including Si, organic, thin film, CIGS, etc.

The C-V instrument integrates directly into the Model 4200-SCS chassis. It can be purchased as an upgrade to existing systems or as an option for new systems.

MEASUREMENT ACCURACY ⁴

Example of C/G Measurement Accuracy

Frequency	Measured Capacitance	C Accuracy ¹	G Accuracy ^{1,2}
10 MHz ³	1 pF	$\pm 0.92\%$	± 260 ns
	10 pF	$\pm 0.32\%$	± 990 ns
	100 pF	$\pm 0.29\%$	± 9 μ s
1 MHz	1 nF	$\pm 0.35\%$	± 99 μ s
	1 pF	$\pm 0.38\%$	± 42 ns
	10 pF	$\pm 0.16\%$	± 65 ns
100 kHz	100 pF	$\pm 0.09\%$	± 590 ns
	1 nF	$\pm 0.09\%$	± 4 μ s
	10 pF	$\pm 0.17\%$	± 15 ns
10 kHz	100 pF	$\pm 0.18\%$	± 59 ns
	1 nF	$\pm 0.08\%$	± 450 ns
	10 nF	$\pm 0.08\%$	± 3 μ s
1 kHz	100 pF	$\pm 0.26\%$	± 15 ns
	1 nF	$\pm 0.15\%$	± 66 ns
	10 nF	$\pm 0.08\%$	± 450 ns
100 nF	100 nF	$\pm 0.08\%$	± 3 μ s
	1 nF	$\pm 0.69\%$	± 40 ns
	10 nF	$\pm 0.25\%$	± 120 ns
1 μ F	100 nF	$\pm 0.10\%$	± 500 ns
	1 μ F	$\pm 0.15\%$	± 10 μ s

NOTES

- The capacitance and conductance measurement accuracy is specified under the following conditions: $D_X < 0.1$.
- Conductance accuracy is specified as the maximum conductance measured on the referenced capacitor.
- These specs are typical. Typical and supplemental specs are non-warranted, apply at 23°C, and are provided solely as useful information.
- Integration time: 1s or 10s below 10kHz.
Test signal level: 30mV rms.
At the rear panel of the 4210-CVU.
All specifications apply at 23°C \pm 5°C, within one year of calibration, RH between 5% and 60%, after 30 minutes of warmup.

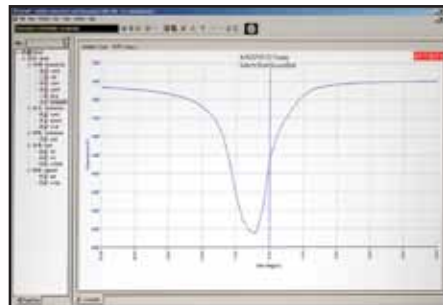

SUPPLEMENTAL CABLE SPECIFICATION ³

4210-CVU Typical C Accuracy with 1.5m Cables (supplemental)

Measured Capacitance	1 kHz	10 kHz	100 kHz	1 MHz	10 MHz
1 pF	N/A	$\pm 8.38\%$	$\pm 1.95\%$	$\pm 0.43\%$	N/A
10 pF	N/A	$\pm 0.94\%$	$\pm 0.21\%$	$\pm 0.18\%$	$\pm 1\%$
100 pF	N/A	$\pm 0.29\%$	$\pm 0.20\%$	$\pm 0.15\%$	$\pm 1\%$
1 nF	$\pm 0.72\%$	$\pm 0.17\%$	$\pm 0.12\%$	$\pm 0.16\%$	$\pm 2\%$
10 nF	$\pm 0.28\%$	$\pm 0.12\%$	$\pm 0.13\%$	$\pm 0.25\%$	$\pm 2\%$
100 nF	$\pm 0.12\%$	$\pm 0.13\%$	$\pm 0.22\%$	$\pm 1.14\%$	N/A
1 μ F	$\pm 0.17\%$	$\pm 0.21\%$	N/A	N/A	N/A

4210-CVU Typical C Accuracy with 3m Cables (supplemental)

Measured Capacitance	1 kHz	10 kHz	100 kHz	1 MHz	10 MHz
1 pF	N/A	$\pm 8.5\%$	$\pm 2.05\%$	$\pm 0.57\%$	N/A
10 pF	N/A	$\pm 0.96\%$	$\pm 0.23\%$	$\pm 0.21\%$	$\pm 1\%$
100 pF	N/A	$\pm 0.29\%$	$\pm 0.20\%$	$\pm 0.17\%$	$\pm 1\%$
1 nF	$\pm 0.72\%$	$\pm 0.17\%$	$\pm 0.12\%$	$\pm 0.18\%$	$\pm 2\%$
10 nF	$\pm 0.28\%$	$\pm 0.12\%$	$\pm 0.13\%$	$\pm 0.27\%$	$\pm 2\%$
100 nF	$\pm 0.12\%$	$\pm 0.13\%$	$\pm 0.22\%$	$\pm 1.16\%$	N/A
1 μ F	$\pm 0.17\%$	$\pm 0.21\%$	N/A	N/A	N/A

CVU CONFIDENCE CHECK

The 4210-CVU includes a diagnostic tool called Confidence Check. It allows users to check the integrity of open and short connections and connections to a device-under test (DUT). When the Model 4210-CVU is connected to a DUT, Confidence Check displays the measured readings in real time. This also allows Confidence Check to be used as a C-V meter to perform quick and accurate measurements.

Model 4200-CVU-Power Specifications

C-V POWER PACKAGE TYPICAL PERFORMANCE CHARACTERISTICS

MEASUREMENT PARAMETERS: Cp-Gp, DCV, timestamp.

RANGING: 1pF to 1nF.

MEASUREMENT TERMINALS: 2-wire SMA, with BNC adapters.

TEST SIGNAL: 100kHz to 10MHz, 10mV to 100mV.

DC VOLTAGE SOURCE: $\pm 200\text{V}$ with 5mV resolution.

DC CURRENT: 100mA or 300mA maximum.

TYPICAL CP ACCURACY @ 1MHz: 1.0%.

DC CURRENT SENSITIVITY: 10nA/V.

SMU BIAS TERMINALS SUPPORTED: 4.

1.888.KEITHLEY (U.S. only)

www.keithley.com

KEITHLEY

A GREATER MEASURE OF CONFIDENCE

4225-PMU, 4225-RPM, and 4220-PGU Specifications

TYPICAL PERFORMANCE WINDOW

The 4225-PMU represents a new generation of ultra-fast I-V measurement capability. Because measurement speed is integrally linked to settling time, accuracy, resolution, and noise, the following chart was created to illustrate the typical measurement performance that can be achieved. This chart is neither the maximum (best) performance nor a guaranteed specification; it is simply intended to offer users an indication of the performance achievable with this new module. The timing parameters below are the suggested minimums for the measurement type. These suggested values do not include settling time for the interconnect or the device-under-test.

TYPICAL MINIMUM TIMING PARAMETERS FOR CURRENT MEASUREMENT¹ 4225-PMU ULTRA-FAST I-V MODULE (with or without optional 4225-RPM Remote Amplifier/Switch)

	10V Range		40V Range		
	10 mA	200 mA	100 μ A	10 mA	800 mA
Recommended Minimum Pulse Width ²	160 ns	70 ns	6.4 μ s	770 ns	770 ns
Recommended Minimum Measure Window ²	20 ns	20 ns	1 μ s	100 ns	100 ns
Recommended Minimum Transition Time ³	20 ns	20 ns	1 μ s	100 ns	100 ns
Noise ⁴	15 μ A	50 μ A	75 nA	5 μ A	200 μ A
Settling Time ⁵	100 ns	30 ns	4 μ s	500 ns	500 ns

TYPICAL MINIMUM TIMING PARAMETERS FOR CURRENT MEASUREMENT¹ 4225-RPM REMOTE AMPLIFIER/SWITCH (RPM optional to 4225-PMU)

	10V Range				
	100 nA	1 μ A	10 μ A	100 μ A	1 mA
Recommended Minimum Pulse Width ²	134 μ s	20.4 μ s	8.36 μ s	1.04 μ s	370 ns
Recommended Minimum Measure Window ²	10 μ s	1.64 μ s	1 μ s	130 ns	40 ns
Recommended Minimum Transition Time ³	1 μ s	360 ns	360 ns	40 ns	30 ns
Noise ⁴	200 pA	2 nA	5 nA	50 nA	300 nA
Settling Time ⁵	100 μ s	15 μ s	6 μ s	750 ns	250 ns

TYPICAL MINIMUM TIMING PARAMETERS FOR VOLTAGE MEASUREMENT¹ 4225-PMU and 4225-RPM

	4225-PMU		4225-RPM
	10 V	40 V	10 V
Recommended Minimum Pulse Width ²	70 ns	150 ns	160 ns
Recommended Minimum Measure Window ²	20 ns	20 ns	20 ns
Recommended Minimum Transition Time ³	20 ns	100 ns	20 ns
Noise ⁴	2 mV	8 mV	1 mV
Settling Time ⁵	30 ns	30 ns	100 ns

NOTES FOR THE TYPICAL PERFORMANCE WINDOW SECTION:

- All typical values measured with an open circuit.
- Using default measure window of 75% to 90% of pulse top. Recommended minimum pulse width = (Settling Time) / 75%.
- Recommended rise/fall time to minimize overshoot.
- RMS noise measured over the Recommended Minimum Measure Window for the given voltage or current range, typical.
- Time necessary for the signal to settle to the DC accuracy level. (Example: 10mA settling time on the PMU 10V range is defined when the signal is within 1.25% of the final value. This calculation: Accuracy = 0.25% + 100 μ A = 0.25% + (100 μ A/10mA) = 0.25% + 1% = 1.25%.)

4225-PMU ACCESSORIES SUPPLIED

SMA to SMA cable, 2m, 4 ea (CA-404B)
SMA to SSMC Y-cable, 6 inch (15 cm), 2 each (4200-PRB-C)

4225-RPM ACCESSORIES SUPPLIED

SMA Cable, 8 inch (20 cm), 1 each (CA-452A)
Triax to BNC Adapter, 1 each (7078-TRX-GND)
BNC to SMA adapter, 1 each (CS-1247)
RPM Cable, 2.1 m, 1 each (CA-547-2A)
Magnetic Base, 1 each (4200-MAG-BASE)

TYPICAL MAXIMUM VOLTAGE AND CURRENT⁶

4225-PMU and 4220-PGU

Resistance ⁷	10V Range		40V Range	
	Maximum V ⁷	Maximum I ⁷	Maximum V ⁷	Maximum I ⁷
1 Ω	0.196 V	196 mA	0.784 V	784 mA
5 Ω	0.909 V	182 mA	3.64 V	727 mA
10 Ω	1.67 V	167 mA	6.67 V	667 mA
25 Ω	3.33 V	133 mA	13.3 V	533 mA
50 Ω	5.00 V	100 mA	20.0 V	400 mA
100 Ω	6.67 V	66.7 mA	26.7 V	267 mA
250 Ω	8.33 V	33.3 mA	33.3 V	133 mA
1 k Ω	9.52 V	9.5 mA	38.1 V	38.1 mA
10 k Ω	9.95 V	995 μ A	39.8 V	3.98 mA

6. To calculate the approximate maximum current and voltage for any resistance:

$$I_{MAX} = V \text{ range} / (50\Omega + \text{Resistance})$$

$$V_{MAX} = I_{MAX} \cdot \text{Resistance}$$

where Resistance is the total resistance connected to the PMU or PGU channel and V range is either 10 or 40.

Example: 10V range using R = 10 Ω (for DUT + interconnect)

$$I_{MAX} = V \text{ range} / (50 + R) = 10 / (50 + 10) = 10 / 60 = 0.167A$$

$$V_{MAX} = I_{MAX} \cdot R = 0.167 \cdot 10 = 1.67V$$

7. Typical maximum at pulse output connector. Resistance is the total resistance connected to the pulse output connector, including device and interconnect.

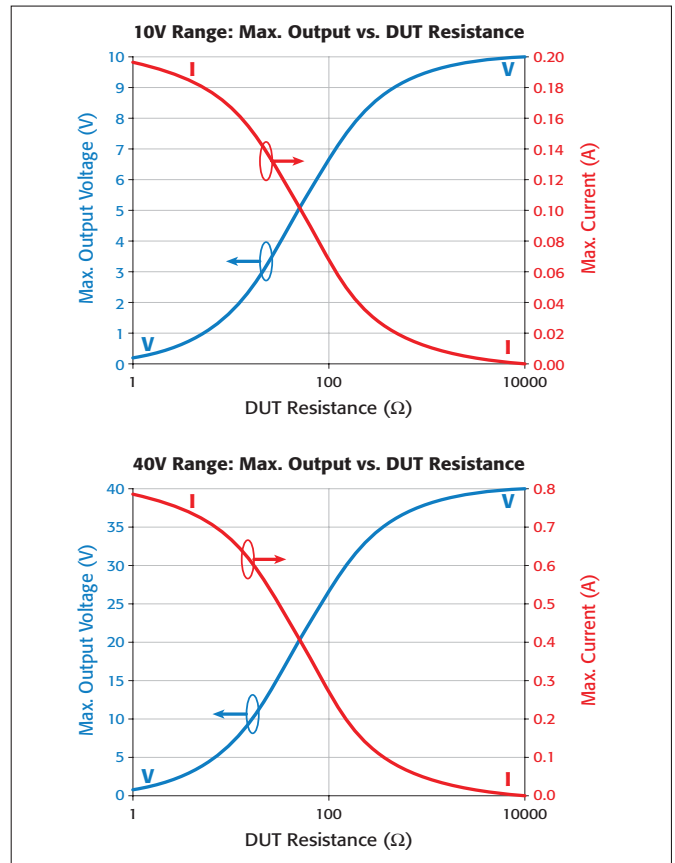

4225-PMU and 4220-PGU Specifications ¹

PULSE/LEVEL ²

		10V Range	40V Range
V _{OUT}	50 Ω into 1 MΩ	-10 V to +10 V	-40 V to +40 V
V _{OUT}	50 Ω into 50 Ω	-5 V to +5 V	-20 V to +20 V
Accuracy		±(0.5% + 10 mV)	±(0.2% + 20 mV)
Resolution	50 Ω into 50 Ω	<250 μV	<750 μV
	50 Ω into 1 MΩ	<0.5 mV	<1.5 mV
Overshoot/Pre-shoot/ Ringing ³	50 Ω into 50 Ω	±(3% + 20 mV)	±(3% + 80 mV)
	50 Ω into 50 Ω, typical best case	±(2% + 20 mV)	±(0.8% + 40 mV)
Baseline Noise		±(0.3% + 1 mV) RMS typical	±(0.1% + 5 mV) RMS typical
Source Impedance		50 Ω Nominal	50 Ω Nominal
Current into 50Ω Load (at full scale)		±100 mA typical	±400 mA typical
Short Circuit Current		±200 mA	±800 mA
Output Connectors		SMA	SMA
Output Limit		Programmable limit to protect the device under test	

TIMING

	10 V Range Source Only	10 V Range with Meas.	40 V Range Source Only	40 V Range with Meas.
Frequency Range	1 Hz to 50 MHz	1 Hz to 8.3 MHz	1 Hz to 10 MHz	1 Hz to 3.5 MHz
Timing Resolution	10 ns	10 ns	10 ns	10 ns
RMS Jitter (period, width), typical	0.01% + 200 ps	0.01% + 200 ps	0.01% + 200 ps	0.01% + 200 ps
Period Range	20 ns to 1 s	120 ns to 1 s	100 ns to 1s	280 ns to 1s
Accuracy	±1%	±1%	±1%	±1%
Pulse Width Range	10 ns to (Period-10 ns)	60 ns to (Period-10 ns)	50 ns to (Period-10 ns)	140 ns to (Period-10 ns)
Accuracy	±(1% + 200 ps)	±(1% + 200 ps)	±(1% + 5 ns)	±(1% + 5 ns)
Programmable Transition Time (0%-100%)	10 ns to 33 ms	20 ns to 33 ms	30 ns to 33 ms ⁴	100 ns to 33 ms
Transition Slew Rate Accuracy	±1% (transitions > 100 ns)	±1% (transitions > 100 ns)	±1% (transitions > 1 μs)	±1% (transitions > 100 ns)
Solid State Relay Open/Close Time	25 μs	25 μs	25 μs	25 μs

CURRENT MEASUREMENT (4225-PMU Only)

	10 V Range			40 V Range	
Current Measure Ranges	10 mA	200 mA	100 μA	10 mA	800 mA
Accuracy (DC)	±(0.25% + 100 μA)	±(0.25% + 250 μA)	±(0.25% + 1 μA)	±(0.5% + 100 μA)	±(0.25% + 3 mA)

4225-RPM CURRENT MEASUREMENT

	10 V Range					
Current Measure Ranges	100 nA	1 μA	10 μA	100 μA	1 mA	10 mA
Accuracy (DC)	±(0.5% + 1 nA)	±(0.5% + 1 nA)	±(0.5% + 30 nA)	±(0.5% + 100 nA)	±(0.5% + 1 μA)	±(0.5% + 10 μA)

4225-PMU and 4225-RPM VOLTAGE MEASUREMENT

	±10V PMU	±40V PMU	±10V RPM
Accuracy (DC)	±(0.25% + 10 mV)	±(0.25% + 40 mV)	±(0.25% + 10 mV)

NOTES

- Unless stated otherwise, all specifications assume a 50Ω termination.
 - Level specifications are valid after 50ns typical settling time (after slewing) for the 10V source range and after 500ns typical settling time (after slewing) for the 40V source range into a 50Ω load.
 - With transition time of 20ns (0%-100%) for the 10V source range and 100ns (0%-100%) for the 40V source range.
 - 40V Range minimum programmable transition time (source only) is 30ns for voltage <10V and 100ns for voltages >10V.
 - For multiple 4225-PMU or 4220-PGU cards in a single 4200-SCS chassis.
 - Per channel.
- All specifications apply at 23° ±5°C, within one year of calibration, RH between 5% and 60%, after 30 minutes of warmup.

TRIGGER

- TRIGGER OUTPUT IMPEDANCE: 50Ω.
 TRIGGER OUTPUT LEVEL: TTL.
 TRIGGER IN IMPEDANCE: 10kΩ.
 TRIGGER IN LEVEL: TTL.
 TRIGGER IN TRANSITION TIMING, MAXIMUM: <100ns.
 TRIGGER IN TO PULSE OUTPUT DELAY: 400ns.
 TRIGGER SYNCHRONIZATION/JITTER ⁵: <2ns.

SEGMENT ARB® AND TIMING

4220-PGU, 4225-PMU w/ or w/o 4225-RPM

MAX. NUMBER OF SEGMENTS ⁶: 2048.

MAX. NUMBER OF SEQUENCES ⁶: 512.

MAX. NUMBER OF SEQUENCE LOOPS: 10¹².

TIME PER SEGMENT: 20ns to 40s.

SEGMENT TIMING RESOLUTION: 10ns.

CONTROL PARAMETERS FOR EACH SEGMENT:

- Start V
- Stop V
- Duration
- Measurement window (PMU or PMU+RPM only)
- Measurement type (PMU or PMU+RPM only)

RMS JITTER (SEGMENT): 0.01 % + 200 ps typical.

VOLTAGE SOURCE ABSOLUTE BEST PERFORMANCE

When used only as a voltage source (that is, without measurements of voltage or current), the Model 4225-PMU can actually exceed the level of performance listed in these specifications. The following table is provided only to offer the user a clearer idea of the Model 4225-PMU's absolute best performance as achievable under optimal conditions. This should not be interpreted as a guarantee that the Model 4225-PMU will achieve this level of performance in typical use cases.

10V RANGE:

- Rise Time: <10ns.
- Pulse Width: 10ns (full width half maximum).
- Period: 20ns.
- Overshoot/Preshoot/Ringing: ±(2% + 20mV).

40V RANGE:

- Rise Time: 50ns to 10V, 100ns to 40V.
- Pulse Width: 50ns.
- Period: 100ns.
- Overshoot/Preshoot/Ringing: ±(0.5% + 40mV).

1.888.KEITHLEY (U.S. only)

www.keithley.com

KEITHLEY

A GREATER MEASURE OF CONFIDENCE

4200-SCS

4200-BTI-A Ultra-Fast NBTI/PBTI Option

The Model 4200-BTI-A package is ideal for wafer- and cassette-level automation. It combines Keithley's advanced DC I-V and ultrafast I-V measurement capabilities with automatic test executive software to provide the most advanced NBTI/PBTI test platform available in the semiconductor test industry. The 4200-BTI-A package includes all the instruments, interconnects, and software needed to make the most sophisticated NBTI and PBTI measurements on leading-edge silicon CMOS technology, including:

- One Model 4225-PMU Ultra-Fast I-V Module
- Two Model 4225-RPM Remote Amplifier/Switches
- Automated Characterization Suite (ACS) Standard Version 4.2 Software (or later)
- Ultra-Fast BTI Test Project Module
- Cabling

The Model 4200-BTI-A offers the best high-speed, low-current measurement sensitivity available in a single-box integrated solution. For example:

- Supports sub-microsecond pulse characterization of drain current at reduced drain voltage, minimizing drain-to-source fields that could otherwise skew test results.
- Ensures that source/measure instrumentation won't be the limiting factor when making low-level measurements.

The ACS software, which is provided in the package, supports building complex test sequences, including up to 20 measurement sequences and full prober integration. It also:

- Easily integrates DC I-V and ultra-fast I-V measurements into a pre- and post-stress measurement sequence.
- Characterizes degradation and recovery behaviors using either AC or DC stress.
- Incorporates single pulse charge trapping (SPCT) measurements into longer stress-measure sequences.

Semiconductor Characterization System Technical Data

Specifications

4225-RPM REMOTE AMPLIFIER/SWITCH Optional Accessory for the 4225-PMU

The 4225-RPM provides lower current measurement ranges to the 4225-PMU.

- Low current measure ranges supports wide range of measurements, from nanotechnology to BTI (Bias Temperature Instability) on leading-edge CMOS devices
- This is a single-channel accessory; order two Model 4225-RPMs to support the two channels of the Model 4225-PMU.
- Supports switching to the Model 4200-SCS's SMUs or 4210-CVU, allowing for a wide range of tests without re-cabling.
- Built-in bypass mode allows access to the Model 4225-PMU's higher current measurement ranges.

PULSE/LEVEL¹

	4225-PMU with 4225-RPM
V _{OUT}	-10 V to +10 V
Accuracy ² into open load	±(0.5% ± 10 mV)
Resolution	<0.5 mV
Output Connectors	Triaxes, source and sense
Baseline Noise	±(0.39% + 1 mV) RMS typical
Overshoot/Pre-shoot/Ringing ³	±2% of amplitude ±20 mV

4225-RPM REMOTE AMPLIFIER/SWITCH (must be used in conjunction with 4225-PMU)

TYPICAL MINIMUM TIMING PARAMETER FOR CURRENT MEASUREMENT

Range	100 nA	1 μA	10 μA	100 μA	1 mA	10 mA
Recommended Minimum Pulse Width ^{4,5}	134 μs	20.4 μs	8.36 μs	1.04 μs	370 ns	160 ns
Recommended Minimum Measure Window ⁵	10 μs	1.64 μs	1 μs	130 ns	40 ns	20 ns
Accuracy (DC)	±(0.5% + 1nA)	±(0.5% + 1nA)	±(0.5% + 30nA)	±(0.5% + 100nA)	±(0.5% + 1μA)	±(0.5% + 10μA)
Recommended Minimum Transition Time ^{5,6}	1 μs	360 ns	360 ns	40 ns	30 ns	20 ns
Noise ^{5,7}	200 pA	2 nA	5 nA	50 nA	300 nA	1.5 μA
Settling Time ^{5,8}	100 μs	15 μs	6 μs	750 ns	250 ns	100 ns

VOLTAGE MEASURE

MAX. VOLTAGE: ±10V.

RECOMMENDED MINIMUM PULSE WIDTH^{4,5}: 160ns.

RECOMMENDED MINIMUM MEASURE WINDOW⁵: 20ns.

ACCURACY (DC): 0.25% + 10mV.

RECOMMENDED MINIMUM TRANSITION TIME^{5,6}: 20ns.

NOISE^{5,7}: 1mV.

SETTLING TIME^{5,8}: 100ns.

NOTES

1. Performance at the triax output connectors of the 4225-RPM when using a 2m RPM interconnect cable between the 4225-PMU and 4225-RPM Remote Pulse Measure unit.
2. 100mV to 10V.
3. Typical, with transition time of 100ns (0%–100%).
4. Recommended minimum pulse width = (Settling time)/0.75.
5. Typical values, into an open.
6. Recommended rise/fall time to minimize overshoot.
7. RMS noise measured over the Recommended Minimum Measure Window for the given voltage or current range, typical.
8. Time necessary for the signal to settle to the DC accuracy level. (Example: the 10mA measurement range's settling time refers to the period required for the signal to settle to within 0.35% of the final value. Calculated as Accuracy = 0.25% + 10μA = 0.25% + (10μA/10mA) = 0.25% + 0.1% = 0.35%.)

All specifications apply at 23° ±5°C, within one year of calibration, RH between 5% and 60%, after 30 minutes of warmup

1.888.KEITHLEY (U.S. only)

www.keithley.com

KEITHLEY

A GREATER MEASURE OF CONFIDENCE

4200-SCS

Semiconductor Characterization System Technical Data

4200-SCP2 1.25GS Dual-Channel Oscilloscope Card and 4200-SCP2HR 200MS Dual-Channel Oscilloscope Card Specifications¹

ANALOG INPUT¹

	4200-SCP2	4200-SCP2HR
No. of Channels	2	2
Bandwidth (50Ω)	DC to 750 MHz	DC to 250 MHz, typical
Bandwidth (1MΩ)	DC to 350 MHz	DC to 125 MHz, typical
Full Scale Input Range (50 Ω)	0.05, 0.1, 0.25, 0.5, 1, 2, 5, 10 (Vp-p)	0.05, 0.1, 0.25, 0.5, 1, 2, 5, 10 (Vp-p)
Full Scale Input Range (1 MΩ)	0.1, 0.2, 0.5, 1, 2.5, 5, 10, 20, 50, 100 (Vp-p)	0.25, 0.5, 1.25, 2.5, 5, 10, 25, 50 (Vp-p)
DC Gain Accuracy	<±1% of full scale	< ±0.25% of full scale
Impedance	1 MΩ 12 pF or 50 Ω	1 MΩ 12 pF or 50 Ω
Impedance Accuracy	±1%	±1%
Coupling	DC or AC	DC or AC
Offset Adjust	±(full scale range/2)	±(full scale range/2)
Offset Accuracy	±(1% offset + 1% full scale)	±1%
Input Connectors	BNC	BNC
Absolute Maximum Input (50 Ω)	±5V DC	±5V DC
Absolute Maximum Input (1 MΩ)	±210V DC	±210V DC

ANALOG-TO-DIGITAL CONVERTER

	4200-SCP2	4200-SCP2HR
Resolution	8 bit	16 bit
Sample Rate	2.5 kS/s to 1.25 GS/s in 1, 2.5, 5 steps	10 kS/s to 200 MS/s in 1, 2.5, 4, 5 steps
Memory Depth	2.5 GS/s (1 channel interleaved) 1 MS/channel	400 MS/s (1 channel interleaved) 1 MS/channel
Acquisition Time Range	2 MS on 1 channel, interleaved	2 MS on 1 channel, interleaved
Acquisition Modes	50 ns to 419 seconds	250 ns to 3,355 seconds
	Normal, Average, Envelope, and Equivalent-time	Normal, Average, Envelope, and Equivalent-time

TRIGGER

	4200-SCP2	4200-SCP2HR
Trigger Source	Channels 1 or 2, External, Pattern, Software	Channels 1 or 2, External, Pattern, Software
Post-Trigger Delay	0 to 655 seconds	0 to 655 seconds
Pre-Trigger Delay	0 to waveform time	0 to waveform time
Trigger Hold Off Range	0 to 655 seconds	0 to 655 seconds
Trigger Modes	Edge or Pulse Width	Edge or Pulse Width
Edge Trigger Mode	Rising or Falling Edge	Rising or Falling Edge
Pulse Width Range	20ns to 655 seconds, 10ns resolution	20ns to 655 seconds, 10ns resolution
External Trigger Input	TTL Compatible, 10 kΩ input impedance	TTL Compatible, 10 kΩ input impedance
Connector	SMB	SMB

OPTIONAL SCOPE PROBE: 4200-SCP2-ACC

BANDWIDTH: 70MHz (4200-SCP2); 15MHz (4200-SCP2HR).

ATTENUATION: 1×.

MAX DC: 300V DC rated.

LOADING: 100pF and 1MΩ.

LENGTH: 1m.

CONNECTOR: BNC.

NOTES

1. Inputs are referenced to 4200 chassis ground

All specifications apply at 23°±5°C, within 1 year of calibration, RH between 5% and 60%, after 30 minutes of warmup.

1.888.KEITHLEY (U.S. only)

www.keithley.com

KEITHLEY

A GREATER MEASURE OF CONFIDENCE

KTE Interactive Software Tools

KTE Interactive includes a variety of software tools for operating and maintaining the 4200-SCS:

- Keithley Interactive Test Environment (KITE)—The 4200-SCS device characterization application
- Keithley User Library Tool (KULT)—Allows test engineers to integrate custom algorithms into KITE using 4200-SCS or external instruments. Requires optional Model 4200-COMPILER.
- Keithley Configuration Utility (KCON)—Allows test engineers to define the configuration of GPIB instruments, switch matrices, and analytical probers connected to the 4200-SCS. It also provides system diagnostics functions.
- Keithley External Control Interface (KXCI)—The 4200-SCS application for controlling the 4200-SCS from an external computer via the GPIB bus or Ethernet.
- KPulse—A graphical user interface (GUI) that is a non-programming alternative to configure and control the installed Model 4225-PMU or 4220-PGU pulse generator cards. It is used for quick tests requiring minimal interaction with other Model 4200-SCS test resources.
- KScope—A graphical user interface (GUI) that provides a non-programming alternative to control the system's scope card (either Model 4200-SCP2HR or Model 4200-SCP2).

Microsoft Windows

Windows Operating System

The operating system is a standard distribution of Microsoft Windows. Upgrades are available for older systems. Contact the Keithley factory for supported versions and service packs.

Data Security and Recovery

Data security and recovery are handled by the included software package, Acronis True Image. This utility can be used to create exact hard disk images, including all operating systems, applications and configuration files, software updates, personal settings, and data. If failures occur that block access to information or affect system operation, or if files are accidentally deleted, the user can easily restore the system and lost data with the Acronis tool.

Data Storage

Fixed disk

Internal high capacity fixed disk drive stores the operating system, application programs, and data files.

DVD/CD-RW Drive

Standard DVD/CD read-write drive is provided for data storage and retrieval.

USB Ports

Four USB 2.0 ports for typical PC USB peripherals.

Connectivity

The 4200-SCS includes two LAN Ethernet ports (10/100/1000) with software drivers installed.

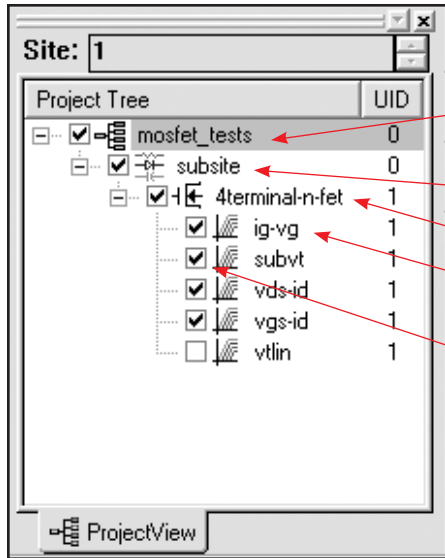

The Keithley Interactive Test Environment (KITE)

The Keithley Interactive Test Environment (KITE) is the Model 4200-SCS Windows device characterization application. It provides advanced test definition, parameter analysis and graphing, and automation capabilities required for modern semiconductor characterization.

KITE Projects

A project is a collection of related tests, organized in a hierarchy that parallels the physical layout of the devices on a wafer. KITE operates on projects using an interface called the project navigator. The project navigator simplifies organizing test files, test execution, and test sequencing.

- The project navigator organizes tests into a logical hierarchy presented in a browser style format. This structure allows users to define projects around wafer testing:
- The project level organizes subsites and controls wafer looping execution.
- The subsite level organizes devices and controls subsite test sequencing and stress/measure looping.
- The device level organizes test modules, manages test module libraries, and controls device test sequencing.
- The test module level performs tests, analyzes data, and plots results.

Selectable checkboxes allow enabling/disabling individual tests/plans.

Test Modules

Within KITE, two types of test modules are provided to capture the test input parameters, data analysis, and plot setting for data. Interactive Test Modules provide a point-and-click interface for defining test input parameters and controlling the 4200-SCS SMUs. User Test Modules provide a fill-in-the-blank interface to either factory-provided or user-written C language subroutines. These subroutines can control internal 4200-SCS instruments and/or external instruments and systems through the RS-232 or GPIB interface. This dual approach provides an extendable test environment that gives the users the same capabilities for data analysis, plotting, output, and automation, whether the instrument used is part of the base system or an external instrument. It also offers users the flexibility to write complex test algorithms for control of either internal or external instruments.

Definition Tab—Interactive Test Module

The Definition Tab of an ITM provides a point-and-click interface for setting test input parameters that control the 4200-SCS SMUs and defining parameter extractions. Two modes are available:

Sweep Mode

Forcing Functions	Common, Voltage Bias, Current Bias (VMU), Voltage Sweep, Current Sweep, Voltage Step, Current Step, Voltage List Sweep, Current List Sweep, Open, C-V Differential Bias, C-V Frequency Sweep, Pulsed I-V, Waveform
Measuring Functions	<p>Precision DC I-V SMU: Measure voltage, current, and timestamp up to 4096 points per SMU</p> <p>C-V (AC Impedance): Cp-Gp, Cs-Rs, Cp-D, Cs-D, R+jX, Z-theta, DCV, frequency, timestamp up to 4096 points per sweep</p> <p>Ultra-Fast I-V: Voltage and current (spot mean) simultaneously in Pulsed I-V mode; voltage, current, and time digitized simultaneously in Waveform Capture mode, up to 1 million digitized points</p>

Interactive Test Modules (ITM) are built from three different major functions: Definition, Sheet, and Graph. The Definition Tab allows the operator to define a sweep or sampling mode test using a graphical approach. The Sheet Tab stores acquired data and provides an Excel[®]-like workbook for viewing and analyzing test results. The Graph Tab provides a full-featured data plotting tool capable of producing report-ready graphs. The Status Tab reports any errors that would interfere with test execution.

Sampling Mode

Precision DC I-V or C-V: Linear sampling at fixed voltage, current, or frequency. Up to 4096 points. Programmable hold time and interval time from 1ms to 1000s.

Ultra-Fast I-V: Simultaneous 14-bit, 5ns to 1ms sampling of voltage and current on up to 8 channels with <3ns synchronization. 4096 data points on every channel. Up to 1 million data points per channel in UTM mode.

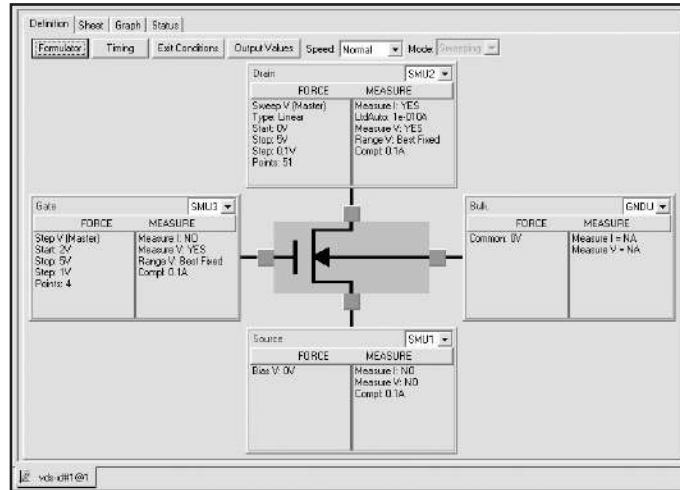

Definition Tab—User Test Module

The Definition Tab of a UTM presents users a tabular fill-in-the-blank interface for entering input parameters to call a C language subroutine. UTMs provide the ability to control internal SMUs and GPIB and RS-232 devices. This screen allows the user to select a user library, a subroutine module, and then enter the desired input parameters. Test results are returned to the Sheet Tab for viewing and analysis. Select UTMs have a GUI interface to simplify operation.

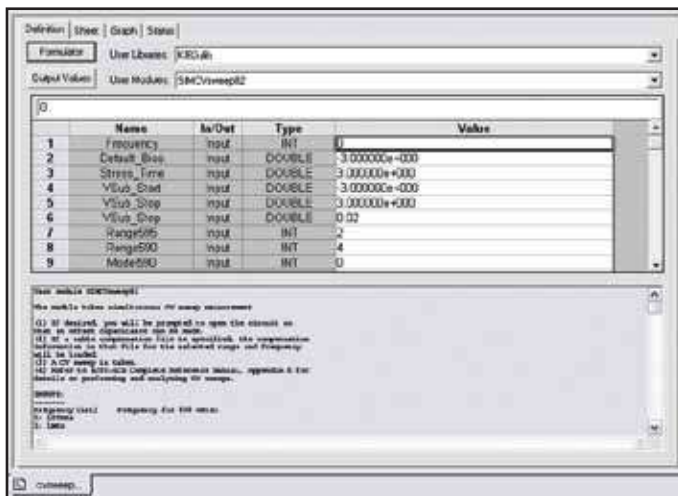

The User Test Module (UTM) has virtually identical functionality as the ITM. However, users enter input parameters in a tabular interface in the UTM's Definition Tab.

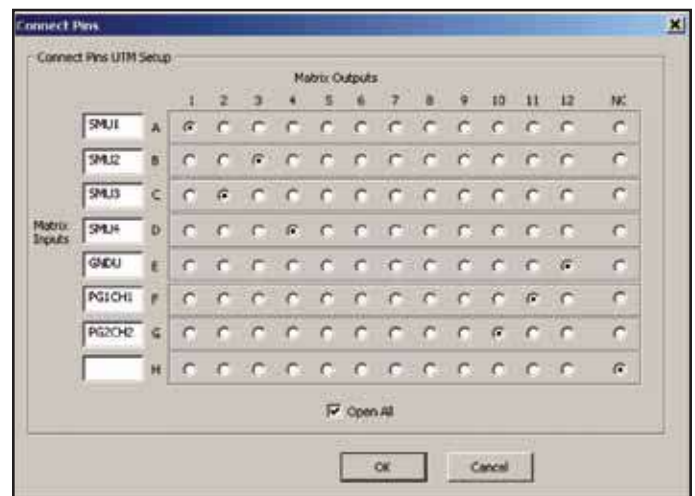

GUI to control switch matrix UTMs.

Data Analysis

Two methods of parameter extraction are available. The Formulator provides automated line fits and parameter extraction. A spreadsheet offers standard spreadsheet analysis tools. Many of the sample libraries include parameter extraction examples.

Formulator functions

The Formulator performs data transformations for performing parameter analysis and line fits. The Formulator supports the following functions:

- **Mathematical Functions**

Addition (+), subtraction (-), division (/), multiplication (*), exponent (^), absolute value (ABS), value at an index position (AT), Average (AVG), moving average (MAVG), conditional computation (COND), derivative (DELTA), differential coefficient (DIFF), exponential (EXP), square root (SQRT), natural logarithm (LN), logarithm (LOG), integral (INTEG), standard deviation (STDEV), moving summation (SUMMV), arc cosine (ACOS), arc sine (ASIN), arc tangent (ATAN), cosine (COS), sine (SIN), tangent (TAN)

- **Conversion Functions**

Radians to degrees (DEG), degrees to radians (RAD)

- **Line Fits and Parameter Extraction Functions**

Exponential line fit (EXPFIT), coefficient a (EXPFITA), coefficient b (EXPFITB)

Linear Fit (LINFIT), linear slope (LINFITSLP), x intercept (LINFITXINT), y intercept (LINFITYINT)

Logarithmic line fit (LOGFIT), coefficient a (LOGFITA), coefficient b (LOGFITB)

Linear Regression line fit (REGFIT), slope (REGFITSLP), x intercept (REGFITXINT), y intercept (REGFITYINT)

Tangent line fit (TANFIT), slope (TANFITSLP), x intercept (TANFITXINT), y intercept (TANFITYINT)

Polynomial line fit including POLYFIT2, POLY2COEFF, and POLYNFIT.

Maximum value (MAX), minimum value (MIN), midpoint (MEDIAN)

- **Search Functions**

Find Down (FINDD), Find Up (FINDU), Find using linear interpolation (FINDLIN)

Maximum position (MAXPOS), minimum position (MINPOS)

First Position (FIRSTPOS), Last Position (LASTPOS)

Sub Array (SUBARRAY), return a specified number of points (INDEX)

Formulator Constants

The Formulator supports user-supplied constants for use in parameter extractions. These constants are factory installed:

$PI = 3.14159 \text{ rad } (\pi)$

$K = 1.38065 \times 10^{-23} \text{ J/K}$ (Boltmann's constant)

$Q = 1.60218 \times 10^{-19} \text{ C}$ (Charge of electron)

$M_0 = 9.10938 \times 10^{-31} \text{ kg}$ (Electron mass)

$E_V = 1.60218 \times 10^{-19} \text{ J}$ (Electron voltage)

$U_0 = 1.25664 \times 10^{-6} \text{ N/A}^2$ (Permeability)

$E_0 = 8.85419 \times 10^{-12} \text{ F/m}$ (Permittivity of a vacuum)

$H = 6.62607 \times 10^{-34} \text{ J-s}$ (Planck's constant)

$C = 2.99792 \times 10^8 \text{ m/s}$ (Speed of light)

$KT/Q = 0.02568 \text{ V}$ (Thermal voltage)

1.888.KEITHLEY (U.S. only)

www.keithley.com

KEITHLEY

A GREATER MEASURE OF CONFIDENCE

Sheet Tab—Data Viewing and Analysis

The Sheet Tab of a test module captures data from a test execution and allows calculations in a spreadsheet. The Sheet Tab operates like an Excel workbook with the following spreadsheets: Data, Calc, Settings, and Append.

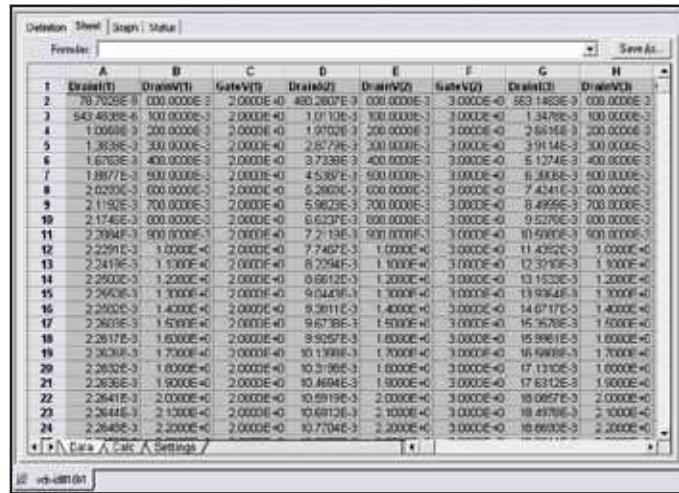

Data Sheet

The Data sheet displays test results in real time. It is read-only so that results cannot be modified.

Calc Sheet

A spreadsheet that operates much like a standard Microsoft Excel spreadsheet is available for computation with each test. The spreadsheet tool supports these functions:

Functions in the KITE Calc sheet

ABS	ACOS	ACOSH	ASIN	ASINH
ATAN	ATAN2	ATANH	AVERAGE	COS
COSH	EXP	FIXED	IF	LN
LOG	LOG10	LOOKUP	MATCH	MAX
MIN	NOW	PI	PRODUCT	ROUND
SIGN	SIN	SINH	SQRT	STDEVP
SUM	SUMSQ	TAN	TANH	VARP

Settings Sheet

The Settings sheet stores the test setup so that when the Sheet tab is exported as a workbook, users can refer to the test configuration. The test setups for multiple appends are also stored.

Append Sheet

Append sheets store test results when the Append button is clicked. Data in Append sheets can be automatically plotted on the graph. Test modules support up to 40 Append sheets.

Graph Tab—Plotting

The Graph Tab is a full-featured plotting tool for creating report-ready graphs. It allows real-time X-Y plotting of acquired and extracted data with one or two Y axes.

- Dual graphs per tab.
- Linear, Semilog, and Log/Log graphs.
- Real-time auto scaling, end of test auto scaling, or manual scaling.
- Six cursors with X-Y readout.
- Graphical line fitting.
- Plot overlay of multiple test executions.
- Four data variable readouts.
- User-formatted comment box, title, and axis labels.
- Choice of engineering units on axes: V (volts), A (amps), s (seconds), S (Siemens), F (farads), Hz (Hertz).
- Choice of engineering symbols on axes: m, μ , n, etc.

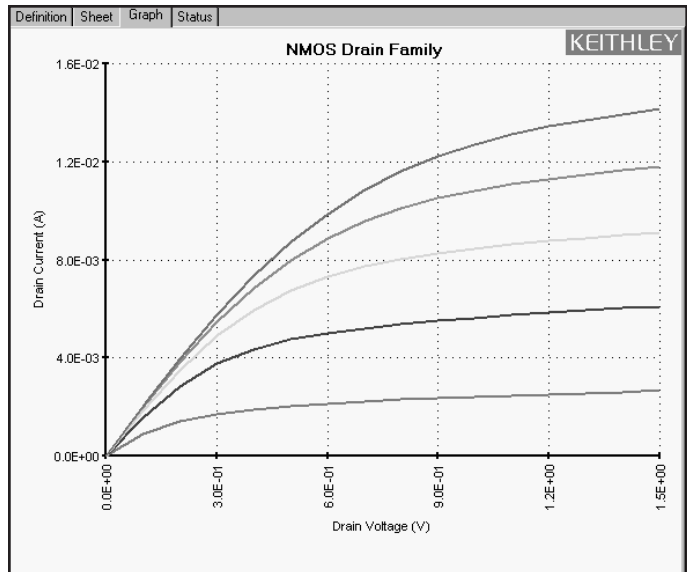

Output

Files

- Sheet tab test results can be saved as a Microsoft Excel Workbook or a delimited ASCII text file.
- Plots can be saved as bit map image (.bmp), JPEG (.jpg), or TIFF (.tif) files.

Display

- Flat Panel: 1024 × 768 resolution.
- External SVGA: Up to 1920 × 1200 resolution.

Printers

Windows printer drivers are used to support a wide variety of print and plot devices.

1.888.KEITHLEY (U.S. only)

www.keithley.com

KEITHLEY

A GREATER MEASURE OF CONFIDENCE

Example Projects

The 4200-SCS includes the following KITE projects to facilitate rapid startup and provide examples for common semiconductor lab applications.

Default Project

Default—The default project includes standard tests for MOSFETs, BIPOLAR transistors, resistors, and diodes. This project helps users get started quickly.

Memory Projects

These projects test floating gate FLASH and embedded NVM memory. They test up to four independent, multi-level pulse channels with up to $\pm 40V$ pulsing on the gate. The waveforms can be predefined or custom. These projects also offer three types of DUT setups: NAND, NOR, and switch based.

Flash-NOR, Flash-NAND, Flash-Switch: These projects provide the ability to send n pulses to the DUT, then perform a V_T sweep. The tests in these projects support four- and eight-terminal testing and allow investigation into program and erase state dependencies on pulse parameters using three types of waveforms: program, erase, and fast program erase. Flash-Switch also includes automatic control of Keithley's Model 707B or Model 708B Switch Matrix.

FlashDisturb-NOR, FlashDisturb-NAND, FlashDisturb-Switch: The Disturb tests pulse stress a device in an array test structure, then perform a measurement, such as V_T , on a device adjacent to the pulsed device. The goal is to measure the amount of V_T shift in adjacent cells, either in the programmed or erased states, when a nearby device is pulsed with either program, erase, or program+erase waveforms. FlashDisturb-Switch also includes automatic control of Keithley's Model 707B or Model 708B Switch Matrix.

FlashEndurance-NOR, FlashEndurance-NAND, FlashEndurance-Switch: These projects pulse stress the DUT with a number of Program+Erase waveform cycles, then periodically measure the V_T . The purpose of these projects is to determine the lifetime of the DUT, based on the number of program+erase cycles withstood by the device before a certain amount of shift, or degradation, in the V_T or other measurement. They also control in-line solid-state relays for the erase waveform cycle. FlashEndurance-Switch also includes automatic control of Keithley's Model 707B or Model 708B Switch Matrix.

PMU-Flash-NAND: Demonstrates the FLASH memory testing capabilities of the Model 4225-PMU.

PRAM: Tests a Phase Change Random Access Memory (PRAM or PCRAM) device using the Model 4225-PMU. Includes set, reset, I-V, and RI tests.

RRAM: Tests Resistive Random Access Memory (RRAM, Memristor) devices using the Model 4225-PMU. Includes conditioning, set, reset, I-V, and other tests.

CMOS Project

CMOS-default: The tests in this project include the most common CMOS device tests that a typical user might perform on a daily basis.

BJT Project

BJT-default: The tests in this project represent the most common BJT tests that a typical user might perform on a daily basis.

Reliability Projects

EM_const_I: Tests electromigration using constant current. It also controls a hot chuck.

HCI_1_DUT: This is a Hot Carrier Injection (HCI) project on one 4-terminal N-MOSFET. No switch matrix is involved in the measurement. Parameters monitored between two successive stresses include I_{Doff} , I_{Don} , I_G , V_T , and G_m . Those parameters are measured on both forward (normal operation condition) and reverse (reverse source and drain bias) conditions. If only a subset of these parameters is needed, it is possible to deselect the test(s) that include the unwanted parametric measurements. It is also possible to add custom tests that will be monitored between successive stresses.

HCI_4_DUT: This is a Hot Carrier Injection (HCI) project on two 4-terminal N-MOSFETs and two 4-terminal p-MOSFETs with a switch matrix. Parameters monitored between two successive stresses include I_{Doff} , I_{Don} , I_G , V_T , and G_m . Those parameters are measured on both forward (normal operation condition) and reverse (reverse source and drain bias) conditions. If only a subset of these parameters is needed, it is possible to deselect the test(s) that include the unwanted parametric measurements. It is also possible to add custom tests that will be monitored between successive stresses. Also, if less than four devices are tested, it is possible to deselect the unwanted device plan in the project tree or modify it for more devices.

HCI_PULSE: This Hot Carrier Injection (HCI) project tests one 4-terminal N-MOSFET using AC stress. It is similar to HCI_1_DUT.

NBTI_1_DUT: This is a Negative Bias Temperature Instability (NBTI) project on one 4-terminal P-MOSFET. Parameters monitored between two successive stresses include I_{Doff} , I_{Don} , I_G , V_T , and G_m . If only a subset of these parameters is needed, it is possible to deselect the test(s) that include the unwanted parametric measurements. It is also possible to add custom tests that will be monitored between successive stresses.

Qbd: This charge-to-breakdown project consists of two Q_{BD} tests on gate dielectrics (V-Ramp and J-Ramp). Those two tests follow JEDEC Standard 35-A. An additional test performs an I-V measurement under normal work conditions to obtain input parameters for the V-Ramp and J-Ramp tests.

Pulse Projects

Chargepumping: This project consists of Charge Pumping (CP) tests that characterize interface and charge-trapping phenomena. There are a variety of tests, including base sweep, amplitude sweep, rise time linear sweep, fall time linear sweep, frequency linear sweep, and frequency log sweep.

ChargeTrapping: The Charge Trapping project uses a single pulse technique to look at device charge trapping and de-trapping behavior within a single, well-configured gate pulse. During the rise and fall times of the voltage ramp, the corresponding drain current response is captured, allowing appropriate $V_{GS}-I_D$ curves to be formed.

ivpgswitch_340x: The tests in this project demonstrate automated device testing using a 4200-SCS, a Keithley Model 3402 pulse generator, and a switch matrix.

ivpgswitch: The tests in this project demonstrate automated device testing using a 4200-SCS, an HP8110A/81110A pulse generator, and a switch matrix.

PMU-DUT-Examples: Contains example test modules to test a MOSFET using the Model 4225-PMU.

PMU-MOSFET: Contains test modules for performing measurements on a MOSFET, including generating DC and pulsed I-V drain families of curves and gate voltage vs. drain current measurements.

PMU-Switch: Provides examples for switching between the Model 4225-PMU, 4200-SMU, and 4200-CVU to the DUT.

PulseIV-Complete: This project provides PIV (pulse IV) tests, including tests that generate I_D vs. V_D graphs and I_D vs. V_G graphs as well as tests that show the effect of self-heating on devices due to DC voltages. (This is the primary sample project included in the 4200-PIV-A package.)

QPulseIV-Complete: This project includes PIV-Q tests that generate I_D vs. V_D and I_G vs. V_D graphs for a FET as well as calibration routines. This project is used to run characterization curves on III-V and LDMOS high power devices using the pulse technique and a non-zero quiescent point.

Solar Cell Project

SolarCell: This project is designed for photovoltaic cells of all types, including crystalline, amorphous, and thin film. I-V, C-V, and resistivity tests are included.

Nanotechnology Project

NanoDevices: This project is designed specifically for Nanotechnology applications and includes the most common tests for nanowires, nanotubes, molecular and CNT transistors, and biocomponents.

C-V Projects

CVU_BJT: Measures capacitance (at 0V bias) between terminals, including C_{be} , C_{bc} , and C_{ec} .

CVU_Capacitor: Performs both a C-V sweep and a C-f sweep on a Metal-Insulator-Metal (MIM) capacitor and calculates standard deviation.

CVU_highV: Performs C-V and C-T sweeps using the Model 4200-CVU-PWR C-V Power Package up to 400V.

CVU_InterconnectCap: Measures C-V of small interconnect capacitance on wafer.

CVU_ivcvswitch: Demonstrates using DC SMUs, 4210-CVU, and 707B/708B (switch matrix) in one project. Switches back and forth between DC and C-V tests and connections to the DUT.

CVU_Lifetime: Determines generation velocity and lifetime testing (Zerbst plot) of MOS capacitors.

CVU-MobileIon: Determines mobile charge using the bias-temperature stress method. Extracts flatband voltage. Includes built-in control of a hot chuck to test a sample at room temperature, heated, then tested again at room temperature to determine flatband shift.

CVU_MOScap: Measures C-V on a MOS capacitor. Extracted parameters include oxide capacitance, oxide thickness, doping density, depletion depth, Debye length, flatband capacitance, flatband voltage, bulk potential, threshold voltage, metal-semiconductor work function difference, and effective oxide charge.

CVU_MOSFET: Makes a C-V sweep on a MOSFET device. Extracted/calculated parameters include oxide thickness, oxide capacitance, flatband capacitance, flatband voltage, threshold voltage, and doping concentration as a function of depletion depth.

CVU_nanowire: Makes a C-V sweep on a two-terminal nanowire device.

CVU_PNjunction: Measures the capacitance of a p-n junction or Schottky diode as a function of the DC bias voltage across the device.

CVU_PVcell: Measures both forward and reverse biased DC characteristics of an illuminated solar cell and extracts parameters such as max power, max current, max voltage, short-circuit current, open-circuit voltage, and efficiency. Also performs characteristic C-V and C-f sweeps.

default: Standard C-V sweeps for generic MOSFETs, diodes, and capacitors.

ivcvswitch: The tests in this project demonstrate the 4200-SCS's integrated I-V, C-V, switching, and probing capabilities.

lifetime: The lifetime project performs high frequency C-t measurements using the Keithley System 82 on MOS capacitors. The minority carrier recombination lifetime and surface velocity are extracted using a Zerbst Plot.

QSCV: Performs Quasistatic C-V using the 4200's SMUs and PAs using the Ramp Rate method.

1.888.KEITHLEY (U.S. only)

www.keithley.com

KEITHLEY

A GREATER MEASURE OF CONFIDENCE

SIMCV: This project provides routines for simultaneous C-V measurement using the Keithley System 82. Typical MOS device parameters, such as doping profile, flat band voltage, threshold voltage, interface trap density, and band bending are extracted.

STVS: This project uses the Keithley System 82 to perform an STVS (Simultaneous Triangular Voltage Sweep) measurement at high temperature. Mobile ion density is extracted.

Miscellaneous Projects

FourPtProbe: This project enables users to make four-point collinear probe measurements on semiconductor materials.

ivswitch: The ivswitch project integrates control of a Keithley Model 707B or Model 708B external switch matrix with device testing.

probesites: The probesites project illustrates how KITE controls semi-automatic probe stations for automated probing of one subsite per site on a single wafer.

probesubsites: The probesubsites project illustrates how KITE controls semi-automatic probe stations when testing multiple subsites per site on a single wafer.

vdp_resistivity: This project enables users to make Van der Pauw measurements on semiconductor materials.

LowCurrent: This project demonstrates sub-10fA performance on four SMUs.

Demonstration Projects

Demo-Default: The tests in this project demonstrate the most common DC tests on an FET. Also, new features that were recently introduced are demonstrated, including pulse SMU, dual sweep, and selecting Engineering labels for the axes.

Demo-ALL: This project collects more than 400 different test libraries in one convenient location.

Automation

Test Sequencing

The Keithley Interactive Test Environment (KITE) provides “point and click” test sequencing on a device, a group of devices (subsite, module, or test element group), or a user-programmable number of probe sites on a wafer.

Prober Control

Keithley provides integrated prober control for supported analytical probers when test sequencing is executed on a user-programmable number of probe sites on a wafer. Contact the factory for a list of supported analytical probers. A “manual” prober mode prompts the operator to perform prober operations during the test sequence.

Supported Probers

Manual Prober

Use the manual prober driver to test without utilizing automatic prober functionality. Manual prober replaces all computer control of the prober with that of the operator. At each prober command, a dialog box appears, instructing the operator what operation is required.

Fake Prober

The Fake prober is useful when prober actions are not desired, such as when debugging, without having to remove prober commands from a sequence.

Supported Semi-automatic (Analytical) Probers

Cascade Microtech Summit™ 12K Series, verified with Nucleus UI

Karl Suss Model PA-200, verified with Wafermap for ProberBench NT, NI-GPIB Driver for ProberBench NT, PBR232 Interface for ProberBench NT, Navigator for ProberBench NT, Remote Communicator for ProberBench NT

MicroManipulator 8860 Prober, verified with pcBridge, pcLaunch, pcIndie, pcWfr, pcNav, pcRouter

Signatone CM500 driver also works with other Signatone probers with interlock controller such as the WL250 and S460SE

Optional Software

Automated Characterization Suite (ACS) for reliability testing, general characterization, and lab automation. For more information on these capabilities, refer to the ACS Systems data sheet.

Keithley User Library Tool (KULT)**(Requires optional Model 4200-COMPILER)**

The Keithley User Library Tool supports creating and integrating C-language subroutine libraries with the test environment. User library modules are accessed in KITE through User Test Modules. Factory supplied libraries provide up and running capability for supported instruments. Users can edit and compile subroutines, then integrate libraries of subroutines with KITE, allowing the 4200-SCS to control an entire test rack from a single user interface.

Standard User Libraries

The 4200-SCS includes the following subroutine libraries, which provide “out of the box” integration and control of Keithley switch matrix systems and other common device characterization equipment. Users access these libraries with the UTM definition tab described on page 15.

chargepumping

This library can be used to study charge trapping and new charge creation on a high κ -Si interface and within high κ film.

hotbuck-temtronics-3010b

This user library controls the temperature of Temtronics 3010b hotchucks. This library sets the target temperature and waits until the target is reached before exiting.

hotbuck_triotek

The hotbuck_triotek user library controls the temperature of TrioTek hot chucks. This library sets the target temperature and waits until the target is reached before exiting.

hp4284ulib

The hp4284ulib user library performs capacitance measurements and C-V sweeps using the Agilent 4284A or 4980 LCR meter.

hp4294ulib

The hp4294ulib user library performs capacitance measurements, C-V sweeps, and frequency sweeps using the Agilent 4294 LCR meter. This library also includes calibration routines to perform phase, open, short, and load calibrations.

hp8110ulib

The hp8110ulib user library performs initialization, setup, and triggering for the Agilent HP8110A (or 81110A) pulse generator.

ki42xxulib

The ki42xxulib user library provides an example subroutine for performing a MOSFET ON resistance (R_{ON}) test routine using the 4200-SCS LPTLIB interface.

ki82ulib

The ki82ulib user library performs simultaneous C-V, C-t, and Q/t measurements and cable compensation for the Keithley System 82 Simultaneous C-V System.

ki340xulib

For use with Keithley Series 3400 pulse/pattern generators.

ki590ulib

The ki590ulib user library performs conductance measurements and 100kHz or 1MHz capacitance measurements, C-V sweeps, C-V pulse sweeps, C-t sweeps, and cable compensation for the Keithley Model 590 C-V Analyzer.

ki595ulib

The ki595ulib user library performs Q/t sweeps and C-V sweeps using the Keithley Model 595 Quasistatic C-V Meter.

kipulseulib

The kipulseulib UTMs control the Model 4205-PG2, 4220-PGU, or 4225-PMU pulse card.

kiscopeulib

The kiscopeulib UTMs control either the Model 4200-SCP2HR or 4200-SCP2 oscilloscope.

matrixulib

The matrixulib user library connects instrument terminals to output pins using a Keithley 707B or 708B switch system when configured as a general-purpose (Model 4200-GP-RS-XX), low current (Model 4200-LC-LS-XX) or ultra-low current (Model 4200-UL-RS-XX or Model 4200-UL-LS-XX) matrix.

parlib

The parlib user library is used for extracting device parameters on bipolar and MOSFET transistors. Extracted parameters include Beta, resistance, threshold voltage, and $V_{DS}-I_D$ sweeps and $V_{GS}-I_D$ sweeps for MOSFETs.

prbgen

The prbgen user library provides test modules to initialize the prober driver, move to the next site or subsite in the prober's wafer map, make or break contact between the probes and the wafer, and obtain the X position and Y position of the prober. Contact the factory for supported probers.

winulib

The winulib user library provides user interface routines for operator inputs and prompts, such as the abort, retry, and ignore decision prompts.

wrlib

The wrlib user library includes routines for performing linear regression and charge-to-breakdown tests (Q_{BD}) on gate dielectrics. Included modules are qbd_rmpv (V-Ramp method) and qbd_rmpj (J-Ramp method).

1.888.KEITHLEY (U.S. only)**www.keithley.com****KEITHLEY**

A GREATER MEASURE OF CONFIDENCE

C language

Microsoft Visual Studio Professional (optional Model 4200-COMPILER) provides the compiler for the Keithley User Library Tool (KULT). Users can develop test subroutine libraries using the full capabilities of C-language programming.

LPTLIB Control

The LPTLIB provides an application programming interface for developing C-language test routines that control integrated test hardware and supported external instruments and switches. This simple connect/source/measure approach eliminates the need for low-level programming and allows the user to focus on creating new test routines quickly.

System Configuration and Diagnostics (KCON)

The Keithley Configuration Utility (KCON) simplifies programming and maintaining a fully integrated test station. KCON provides a single interface for configuring external instruments, switch matrices, and analytical probes, and for executing system diagnostics.

External Instrument Configuration

KCON allows lab managers to integrate external instruments with the 4200-SCS and a supported switch matrix. After the user configures the GPIB addresses for supported instruments, Keithley-supplied libraries will function and test modules can be transferred between 4200-SCS systems without any user modification. In addition to the standard supported instruments, the General Purpose Instrument allows users to develop subroutines and control switches for a generic two-terminal or four-terminal instrument. For the widest possible system extensibility, users can develop their own test libraries for general purpose instruments.

Switch Matrix Configuration

Users define the connection of 4200-SCS instruments and external instruments to device under test (DUT) pins through a supported switch matrix configuration. (See Switch Matrix Support and Configurations). Once connections are defined, users need only enter the instrument terminal name and pin number to establish connections. The 4200-SCS applications and standard user libraries manage the routing of test signals between instrument terminals and DUT pins. The user doesn't need to remember and program row and column closures. Test modules can transfer between 4200-SCS systems without re-entering connection information.

4200-SCS Instrument Diagnostics

Users can confirm system integrity of SMUs, C-V measurement unit, pulse generator, oscilloscopes, and Remote PreAmps by running a system self-test. For more complex problems, the system's configuration analysis tool can generate reports that assist Keithley's Technical Support staff in diagnosing problems.

Keithley External Control Interface (KXCI)

With KXCI, you can use an external computer to control the SMUs and CVU modules in the Model 4200-SCS directly. KXCI also provides you with indirect control of the Ultra-fast I-V and Oscilloscope modules using UTMs via either the built-in GPIB or Ethernet. For the SMUs, the KXCI command set includes an HP 4145 compatibility mode, allowing many programs already developed for the HP4145 to use the 4200-SCS instead.

Support Contracts

Note: ISO-17025/2540.3 accredited calibrations are also available for the base system. Call Keithley for more information.

On-Site Services

Our field service engineers can perform some calibrations and repair services at your facility. Call Keithley to ask about on-site services for the 4200-SCS.

Off-Site Services

Base System

4200-3Y-EW	1-year factory warranty on the base 4200-SCS (including all SMUs and PAs) extended to 3 years from date of shipment. Includes calibration (reports compliant to ANSI Z540-1) and return shipping.
4200-5Y-EW	1-year factory warranty on the base 4200-SCS (including all SMUs and PAs) extended to 5 years from date of shipment. Includes calibration (reports compliant to ANSI Z540-1) and return shipping.
4200-3Y-CAL	3 calibrations within 3 years of purchase of the base 4200-SCS (including all SMUs and PAs) . Before and after data reports compliant with ANSI/NCSL Z540-1. Does not cover Scope or Pulse Generator Cards.
4200-5Y-CAL	5 calibrations within 5 years of purchase of the base 4200-SCS (including all SMUs and PAs) . Before and after data reports compliant with ANSI/NCSL Z540-1. Does not cover Scope or Pulse Generator Cards.

Oscilloscope Option

4200-SCP2-3Y-EW	1-year factory warranty on the 4200-SCS Scope Card (Standard or HR version) extended to 3 years from date of shipment. Includes calibration and return shipping. Requires purchase of 4200-3Y-EW.
4200-SCP2-5Y-EW	1-year factory warranty on the 4200-SCS Scope Card (Standard or HR version) extended to 5 years from date of shipment. Includes calibration and return shipping. Requires purchase of 4200-5Y-EW.

1.888.KEITHLEY (U.S. only)

www.keithley.com

KEITHLEY

A GREATER MEASURE OF CONFIDENCE

Support Contracts

Off-Site Services

Oscilloscope Option (continued)

4200-SCP2-3Y-CAL 3 calibrations within 3 years of purchase of the 4200-SCS Scope Card (Standard or HR version). Requires purchase of 4200-3Y-CAL.

4200-SCP2-5Y-CAL 5 calibrations within 5 years of purchase of the 4200-SCS Scope Card (Standard or HR version). Requires purchase of 4200-5Y-CAL.

Pulse Generator Option

4220-PGU-3Y-EW 1-year factory warranty on the 4220-PGU Dual-Channel Pulse Generator extended to 3 years from date of shipment. Includes calibration and return shipping. Requires purchase of 4200-3Y-EW.

4220-PGU-5Y-EW 1-year factory warranty on the 4220-PGU Dual-Channel Pulse Generator extended to 5 years from date of shipment. Includes calibration and return shipping. Requires purchase of 4200-5Y-EW.

4220-PGU-3Y-CAL 3 calibrations within 3 years of purchase of the 4220-PGU Dual-Channel Pulse Generator. Requires purchase of 4200-3Y-CAL.

4220-PGU-5Y-CAL 5 calibrations within 5 years of purchase of the 4220-PGU Dual-Channel Pulse Generator. Requires purchase of 4200-5Y-CAL.

Ultra-Fast I-V Module Option

4225-PMU-3Y-EW 1-year factory warranty on both the 4225-PMU Ultra-Fast I-V Module and the 4225-RPM Remote Amplifier/Switch extended to 3 years from date of shipment. Includes calibration and return shipping. Requires purchase of 4200-3Y-EW.

4225-PMU-5Y-EW 1-year factory warranty on both the 4225-PMU Ultra-Fast I-V Module and the 4225-RPM Remote Amplifier/Switch extended to 5 years from date of shipment. Includes calibration and return shipping. Requires purchase of 4200-5Y-EW.

4225-PMU-3Y-CAL 3 calibrations within 3 years of purchase of both the 4225-PMU Ultra-Fast I-V Module and the 4225-RPM Remote Amplifier/Switch. Requires purchase of 4200-3Y-CAL.

4225-PMU-5Y-CAL 5 calibrations within 5 years of purchase of both the 4225-PMU Ultra-Fast I-V Module and the 4225-RPM Remote Amplifier/Switch. Requires purchase of 4200-5Y-CAL.

Value-Add Services

APPS SERVICE Customized applications assistance. Examples include:

- Software services – KULT/UTM development and customization
- Applications assistance – test plan development, test process optimization, measurement troubleshooting
- System development – integration of a 4200-SCS with other elements of a test system, such as a switch matrix or a C-V meter

Training services are available. Please contact Keithley for information.

Visit Keithley's Technical Support Web Forums to get answers to your product support and applications questions 24/7.

Other Upgrades

Besides adding the instrument modules listed on page 28, there are other upgrades available for the 4200-SCS/x.

4200-KTEI-x.x 4200-SCS Keithley Test Environment Interactive (KTEI) complete software test suite (latest version). Includes installation CD and instructions. Not available for Version 1 (Windows NT) chassis.

4200-Upgrade Required installation and calibration service when any instrument module is added to any 4200-SCS chassis. Only one 4200-Upgrade required per instrument module upgrade order. Not required for 4200-Chassis-Refurb or the 4200-Complete-Refurb.

4200-Chassis-Refurb

This upgrade service will take Version 2 and Version 3 chassis and upgrade them to the latest instrument backplanes, displays, power supplies, etc. It does not include a new CPU board. Not compatible with Version 1 (Windows NT) systems.

4200-Complete-Refurb

This upgrade service will bring any 4200-SCS chassis (including Version 1 Windows NT systems) up to the latest CPU and instrument capability.

Note: 4200-Chassis-Refurb and 4200-Complete-Refurb restores the 4200-SCS to factory conditions, including re-formatting the hard drive. All existing data and programs will be lost. Be sure to create a backup of all data and projects prior to ordering either of these upgrades.

1.888.KEITHLEY (U.S. only)

www.keithley.com

KEITHLEY

A GREATER MEASURE OF CONFIDENCE

Embedded PC Policy

Caution: Keithley Instruments warrants the performance of the Model 4200-SCS only with the factory-approved Windows Operating System and applications software pre-installed on the 4200-SCS by Keithley Instruments. Systems that have been modified by the addition of un-approved third-party application software (software that is not explicitly approved and supported by Keithley Instruments) are not covered under the product warranty. Model 4200-SCS systems with unapproved software may need to be restored to factory approved condition before any warranty service can be performed (e.g., calibration, upgrade, technical support). Services provided by Keithley Instruments to restore systems to factory approved condition will be treated as out-of-warranty services with associated time and material charges. Approved software is listed in the Reference Manual and under "Approved Third-Party Software" on page 25 of this document.

CAUTION: DO NOT reinstall or upgrade the Windows operating system (OS) on any Model 4200-SCS. This action should only be performed at an authorized Keithley service facility. Violation of this precaution will void the Model 4200-SCS warranty and may render the Model 4200-SCS unusable. Any attempt to reinstall or upgrade the Windows operating system will require a return-to-factory repair and will be treated as an out-of-warranty service, including time and material charges.

Warranty Information

Warranty Summary

This section summarizes the warranties of the 4200-SCS. For complete warranty information, refer to the 4200-SCS Reference Manual. Any portion of the product that is not manufactured by Keithley is not covered by this warranty and Keithley will have no duty to enforce any other manufacturer's warranties.

Hardware Warranty

Keithley Instruments, Inc. warrants the Keithley manufactured portion of the hardware for a period of one year from defects in materials or workmanship; provided that such defect has not been caused by use of the Keithley hardware which is not in accordance with the hardware instructions. The warranty does not apply upon any modification of Keithley hardware made by the customer or operation of the hardware outside the environmental specifications.

Software Warranty

Keithley warrants for the Keithley produced portion of the software or firmware will conform in all material respects with the published specifications for a period of ninety (90) days; provided the software is used on the product for which it is intended in accordance with the software instructions. Keithley does not warrant that operation of the software will be uninterrupted or error-free, or that the software will be adequate for the customer's intended application. The warranty does not apply upon any modification of the software made by the customer.

Approved Third-Party Software:

- Acronis True Image (OEM)
- Adobe Acrobat 8.0 or later
- Adobe Acrobat Reader 8.0 or later
- Diskeeper 9.0 or later
- Kaspersky Anti-Virus 2009 or later
- McAfee Virus Scan Plus 2009 or later
- Microsoft Excel
- Microsoft Internet Explorer 7.0 or later
- Microsoft Word
- Norton AntiVirus 2000 6.0 or later
- Symantec pcAnywhere 11.0
- TrendMicro Anti-Virus 2008 or later
- Visual C++ .net
- Visual Studio 2010 Professional Edition
- Windows XP Professional

Switch Matrix Support and Configurations

Overview

A number of useful standard switch matrix configurations are available for the 4200-SCS. Each standard configuration includes all components, cabling, and instructions for the user to assemble the switch matrix and add the matrix configuration to the 4200-SCS test environment. Once a supported configuration is added to the test environment, the 4200-SCS standard user library (matrixulib) connects instrument terminals to output pins through a simple “fill-in-the-blank” interface.

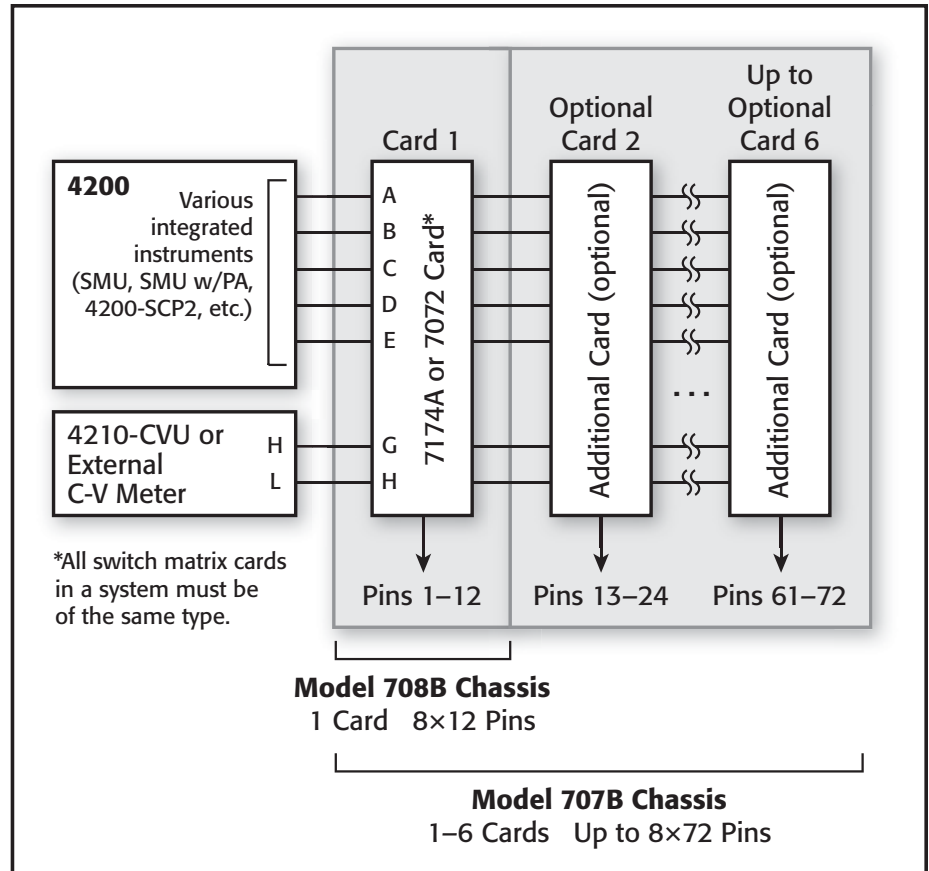

Basic block diagram of 4200-SCS configurations

Ultra-Low Current/Local Sense Configuration (4200-UL-LS-XX)

The Ultra-Low Current/Local Sense switch configuration is built using the Keithley Model 7174A Low Current Matrix Card (with the Model 707B or 708B Switch Matrix), which is designed for semiconductor research, development, and production applications requiring high quality, high performance switching of I-V and C-V signals. This configuration provides eight instrument inputs with up to 72 output pins at only 10fA typical offset current.

4200-UL-LS-12/B (or -12/707B)

- 1 708B (or 707B) Switch Mainframe
- 1 7174A Switch Card
- 12 4200-TRX-3 Cable for each 12 pins
- 1 7007-1 IEEE-488 Cable
- 2 7078-TRX-BNC Adapter

4200-UL-LS-24B, -36B, -48B, -60B, -72B

- 1 707B Switch Mainframe
- 1 7174A Switch Card for each 12 pins
- 12 4200-TRX-3 Cable for each 12 pins
- 1 7007-1 IEEE-488 Cable
- 2 7078-TRX-BNC Adapter

Connector Type: 3-lug triax.

Maximum Signal Level: 200V, 2A.

Offset Current: 100fA max, 10fA typical.

Maximum Leakage: 0.01pA/V.

3dB Bandwidth: 30MHz typical.

Low Current/Local Sense Configuration (4200-LC-LS-XX)

The Low Current/Local Sense switch configuration is built using the Keithley Model 7072 Semiconductor Matrix Card, which is designed for semiconductor applications requiring good quality I-V and C-V signals. The configuration provides eight instrument inputs with up to 72 output pins with less than 1pA offset current.

4200-LC-LS-12/B (or -12/707B)

- 1 708B (or 707B) Switch Mainframe
- 1 7072 Matrix Switch Card
- 12 4200-TRX-3 Cable
- 1 7007-1 IEEE-488 Cable
- 2 7078-TRX-BNC Adapter

4200-LC-LS-24/B, -36/B, -48/B, -60/B, -72/B

- 1 707B Switch Mainframe
- 1 7072 Matrix Switch Card for each 12 pins
- 12 4200-TRX-3 Cable for each 12 pins
- 1 7007-1 IEEE-488 Cable
- 2 7078-TRX-BNC Adapter

Connector Type: 3-lug triax.

Maximum Signal Level: 200V, 1A.

Offset Current: <1pA (Rows A–B).

Maximum Leakage: 0.1pA/V.

3dB Bandwidth: 5MHz typical (Rows G–H).

Accessories and Optional Instrumentation

ACCESSORIES SUPPLIED WITH EVERY CHASSIS

263-ILC-3	Interlock Cable (3m)
4200-KTEI-x.x	System Software and Manuals CD
TL-22	General Tool Kit
TL-24	SMA Torque Wrench

ACCESSORIES SUPPLIED WITH DC SMUs

4200-MTRX-2	Ultra Low Noise SMU Triax Cable (Two supplied for each SMU), 2m (6.6 ft). Not included with SMUs configured with a 4200-PA Remote PreAmp.
4200-RPC-2	Remote PreAmp Cable (One supplied for each PreAmp), 2m (6.6 ft).
4200-TRX-2	Ultra Low Noise PreAmp Triax Cable, 2m (6.6 ft). Two supplied for Ground Unit. Two supplied in replacement of 4200-MTRX-2 cables for each SMU configured with a 4200-PA.
Line Cord	NEMA 5-15P for 100-115VAC or CEE 7/7 (Continental European) for 240VAC.
User Manual	User Manual and Reference Manual supplied on the 4200-SCS Complete Reference CD-ROM. (Printed manual available as an option.)

ACCESSORIES SUPPLIED WITH EACH 4200-CVU-Prober-Kit

237-TRX-BAR	Four Female Triax to Female Triax Adapters
4200-PRB-C	Two SSMC to SMA Cables with local ground
7078-TRX-BNC	Four Male Triax to Female BNC Adapters
7078-TRX-GND	Four Male Triax to Female BNC Adapters (guards removed)
CA-446A	Four SMA Cables, 100Ω, 3m
CS-565	Four Female BNC to Female BNC Adapters
CS-1247	Four Female SMA to Male BNC Adapters
CS-1391	Two SMA Tee Adapters (female, male, female)

ACCESSORIES SUPPLIED WITH EACH 4200-PMU-PROBER KIT

CA-19-2	Four BNC Male to BNC Male Coax Cables (1.5m)
CA-405B	SMA Male to SMA Male Coax Cable (15cm)
CA-451A	SMA Male to SMA Male Coax Cable (11cm)
CA-452A	Two SMA Male to SMA Male Coax Cables (20cm)
CS-565	Two BNC Female to BNC Female Barrels
CS-712	Two BNC Female to Triax Male Adapters
CS-1247	Four SMA Female to BNC Male Adapters
CS-1252	Four SMA Male to BNC Female Adapters
CS-1390	Two Micro Triax (LEMO) to SMA (no guard)
CS-1391	Three SMA Tees, female-male-female

ACCESSORIES SUPPLIED WITH EACH 4210-CVU

CA-447A	Four SMA Cables, male to male, 100Ω, 1.5m
CS-701	Two BNC Tee Adapters
CS-1247	Four Female SMA to Male BNC Adapters

ACCESSORIES SUPPLIED WITH EACH 4210-MMPC-C

CA-533-24A	Two Mini Triax/Full Triax Cables, 100Ω (61cm)
CA-535-4A	Prober Ground Jumper (10cm)
CA-540-12A	Mini Triax/Mini Triax Cable, 100Ω (35cm)
CS-712	Three Triax Male to BNC Female Adapters
CS-737	Triax Tee Adapter, female-male-female
CS-1247	Three SMA Female to BNC Male Adapters
4210-MMPC-304A	Grounding Bracket Assembly
4210-MMPC-305A	Mini Triax, 3-lug, Shorting Plug (shorts center pin to outer shield)

ACCESSORIES SUPPLIED WITH EACH 4210-MMPC-S

CA-532A	MMPC Prober Cable Assembly
CA-534-24A	Two Male Triax to Male Triax Cables, 100Ω (61cm)
CA-535-7A	Prober Ground Jumper (17.8cm)
CS-712	Three Triax Male to BNC Female Adapters
CS-737	Triax Tee Adapter, female-male-female
CS-751	Two Triax Female to Triax Female Adapters
CS-1247	Three SMA Female to BNC Male Adapters
CS-1546	Triax Shorting Plug (shorts center pin to outer shield)

ACCESSORIES SUPPLIED WITH EACH 4225-PMU OR 4220-PGU

4200-PRB-C	Two SMA to SSMC Y-Cable Assemblies (0.15m)
CA-404B	Four SMA to SMA 50Ω Cables (2m)

ACCESSORIES SUPPLIED WITH EACH 4225-RPM

7078-TRX-GND	Triax to BNC Adapter
CA-452A	SMA to SMA 50Ω Cable (0.2m)
CA-547-2A	RPM Cable (2.1m)
CS-1247	BNC to SMA Adapter

OPTIONAL INSTRUMENTATION

4200-CVU-PROBER-KIT	Optional accessory kit for connecting to popular analytical probers
4200-CVU-PWR	CVU Power Package for ±200V C-V
4200-PA	Remote PreAmp Option for 4200-SMU and 4210-SMU, extends SMU to 0.1fA resolution
4200-PMU-PROBER-KIT	Optional accessory kit for connecting ultra-fast I-V modules to popular analytical probers
4200-SCP2	Dual-Channel Integrated Oscilloscope
4200-SCP2HR	High Resolution, Dual-Channel Integrated Oscilloscope
4200-SCP2-ACC	Optional Scope Probe
4200-SMU	Medium Power Source-Measure Unit for 4200-SCS. 100mA to 100fA, 200V to 1μV, 2 Watt
4210-CVU	Integrated C-V Instrument
4210-MMPC-C	Multi-Measurement (I-V, C-V, Pulse) Prober Cable Kit for the Cascade MicroTech 12000 prober series
4210-MMPC-S	Multi-Measurement (I-V, C-V, Pulse) Prober Cable Kit for the Suss MicroTec PA300 prober series
4210-SMU	High Power Source-Measure Unit for 4200-SCS. 1A to 100fA, 200V to 1μV, 20 Watt
4220-PGU	Dual-Channel Pulse Generator, ±40V, 10ns
4225-PMU	Ultra-Fast I-V Module, ±40V, 60ns, 800mA
4225-RPM	Remote Amplifier/Switch for Model 4225-PMU

APPLICATION PACKAGES

4200-BTI-A	Hardware and Software Ultra-Fast Package for complete NBTI/PBTI Testing
------------	---

1.888.KEITHLEY (U.S. only)

www.keithley.com

KEITHLEY

A GREATER MEASURE OF CONFIDENCE

Other Optional Accessories

COMPUTER OPTIONS

4200-MOUSE Microsoft Ambidextrous 2 Button Mouse (Note: a pointing device is integrated with the 4200-SCS keyboard.)

REMOTE PREAMP MOUNTING ACCESSORIES

4200-MAG-BASE¹ Magnetic base for mounting 4200-PA or 4225-RPM on a prober platen
 4200-TMB Triaxial mounting bracket for mounting 4200-PA on a triaxial mounting panel
 4200-VAC-BASE Vacuum base for mounting 4200-PA or 4225-RPM on a prober platen

CABINETS AND MOUNTING ACCESSORIES

4200-CAB-25UX 25U Cabinet (44 in.)
 4200-KEY-RM Slide Rack Mounting Kit for standard keyboard and pointing device
 4200-RM Slide Rack Mounting Kit for 4200-SCS/F and 4200-SCS/C

CONNECTORS, ADAPTERS, AND FIXTURES

237-BAN-3A Triax Cable Center Conductor terminated in a safety banana plug
 237-BNC-TRX Male BNC to 3-lug Female Triax Adapter
 237-TRX-BAR 3-lug Triax Barrel for use with triax interconnect
 237-TRX-T 3-slot Male to Dual 3-Lug Female Triax Tee Adapter
 237-TRX-TBC 3-lug Female Triax Bulkhead Connector
 7078-TRX-BNC Coaxial Connector for connecting coax instruments to a triax matrix
 7078-TRX-GND Male Triax to Female BNC Connector (guards removed)
 8101-4TRX 4-pin Transistor Fixture
 8101-PIV Pulse I-V Demo Fixture
 CA-404B SMA Plug to SMA Plug, RG188, 2m
 CA-405B SMA Plug to SMA Plug, RG188, 6in
 CA-406B SMA Plug to SMA Plug, RG188, 13in
 CA-451A SMA-SMA Plug, RG188, 4.25in
 CA-452A SMA-SMA Plug, RG188, 8in
 CS-565 Female BNC to Female BNC Adapter
 CS-633 Adapter, TRIAX to BNC
 CS-701 BNC Tee Adapter
 CS-1247 SMA Female to BNC Male
 CS-1249 SMA Female to SMB Plug
 CS-1251 BNC Female to SMB Plug
 CS-1252 SMA Male to BNC Female
 CS-1281 SMA Female to SMA Female
 CS-1382 MMBX-to-SMA Adapter
 CS-1390 TRIAX to SMA Adapter, no guard
 CS-1391 SMA TEE Adapter (female, male, female)

ADDITIONAL CABLES¹

236-ILC-3 Interlock Cable, 3m (one included with each 4200-SCS)
 237-ALG-2 Low Noise Triax Cable, 2m (terminated with a 3-slot male triax connector on one end and 3 alligator clips on the other)
 4200-MTRX-1 Ultra Low Noise SMU Triax Cable, 1m (Mini Triax-Triax, connects 4200 SMUs to a test fixture)
 4200-MTRX-2 Ultra Low Noise SMU Triax Cable, 2m (Mini Triax-Triax, connects 4200 SMUs to a test fixture, two included with each 4200 SMU that is not configured with a Remote PreAmp)
 4200-MTRX-3 Ultra Low Noise SMU Triax Cable, 3m (Mini Triax-Triax, connects 4200 SMUs to a test fixture)
 4200-PRB-C SSMC to SMA Cable with local ground
 4200-PRB-C-SMA SMA to SMA Y-cable, 6 in. (15 cm)
 4200-PRB-C-SMB SMA to SMB Y-cable, 6 in. (15 cm)
 4200-RPC-0.3 Remote PreAmp Cable, 0.3m (for use inside prober shield)
 4200-RPC-2 Remote PreAmp Cable, 2m (for remote location of 4200-PA, one included with each 4200-PA)
 4200-RPC-3 Remote PreAmp Cable, 3m (for remote location of 4200-PA)
 4200-RPC-6 Remote PreAmp Cable, 6m (for remote location of 4200-PA)
 4200-TRX-0.3 Ultra Low Noise PreAmp Triax Cable, 0.3m, (Triax-Triax, connects 4200-PA to a test fixture, recommended for remote location of the 4200-PA)
 4200-TRX-1 Ultra Low Noise PreAmp Triax Cable, 1m, (Triax-Triax, connects 4200-PA to a test fixture)
 4200-TRX-2 Ultra Low Noise PreAmp Triax Cable, 2m, (Triax-Triax, connects 4200-PA to a test fixture, two included with each 4200-PA)
 4200-TRX-3 Ultra Low Noise PreAmp Triax Cable, 3m, (Triax-Triax, connects 4200-PA to a test fixture)
 4210-MMPC-C Multi-measurement cable set for Cascade Microtech probers. Requires one set per manipulator.
 4210-MMPC-S Multi-measurement cable set for SUSS MicroTec probers. Requires one set per manipulator.
 7007-1 Double Shielded IEEE-488 Cable (1m)
 7007-2 Double Shielded IEEE-488 Cable (2m)
 CA-19-2 RG-58 Coax Cable, 50Ω (1.5m)
 CA-426B TRIAX to SSMC Cable Assembly
 CA-446A SMA Cable, 100Ω, 3m
 CA-447A SMA Cable, male to male, 100Ω, 1.5m

OTHER ACCESSORIES

4200-CART Roll-around Cart for 4200-SCS
 4200-CASE Transport Case for 4200-SCS
 4200-MAN Printed Manual Set for 4200-SCS (Manual on CD-ROM is included in Base Unit)
 4200-Q-STBL-KIT Stabilization Kit for 4200-PIV-Q

NOTES

- 4200-MAG-BASE is included with 4225-RPM.
- All 4200-SCS systems and instrument options are supplied with required cables (2m length).

4200-SCS

Semiconductor Characterization System Technical Data

PreAmp Mounting and Cabling



It's easy to connect the Model 4200-SCS to a probe station or a switch matrix with standard triax cables.

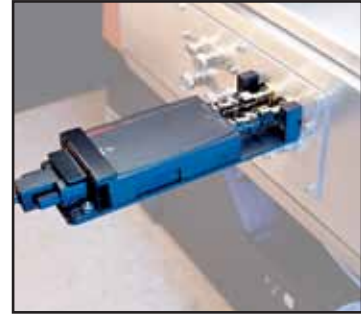
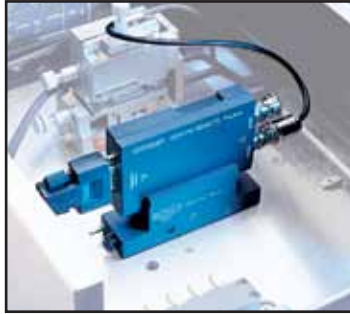

DC PreAmps can be mounted on the probe station with either a platen base or a triax mounting bracket. By reducing the signal path between the DUT and the PreAmp from several feet to a fraction of an inch, the Model 4200-SCS can eliminate cable effects like parasitic capacitance and leakage currents, which provides more accurate low-level measurements.

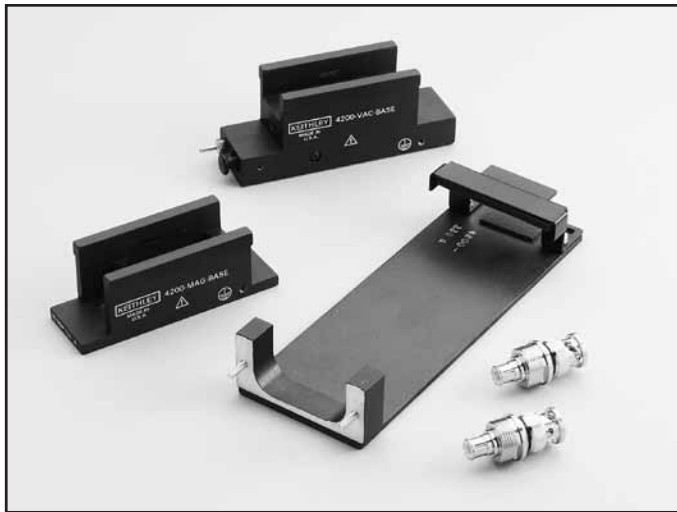

An optional vacuum (Model 4200-VAC-BASE) or magnetic (Model 4200-MAG-BASE) platen mounting base allows the PreAmp to be located next to manipulators on the chuck platen, eliminating measurement problems caused by long cable lengths when performing ultra-low current measurements.

If platen space is not available, the triax mounting bracket (Model 4200-TMB) allows users to locate the DC PreAmp on dual triaxial connectors that may already be installed for HP4156 Kelvin triax cables. This mounting option reduces problems caused by long cables without occupying platen space.



The Model 4225-RPM Remote Amplifier/Switch can be mounted close to the probe needles to reduce the cable effects when performing pulse or other ultra-fast I-V measurements.

4200-SCS

Semiconductor Characterization System Technical Data

4200-SCS Accessories



Model 4200-CAB-XXX
Cabinet



Model 4200-CART
Roll-around cart



Model 4200-CASE
Transport case



Model 4200-KEY-RM
Keyboard rack mount

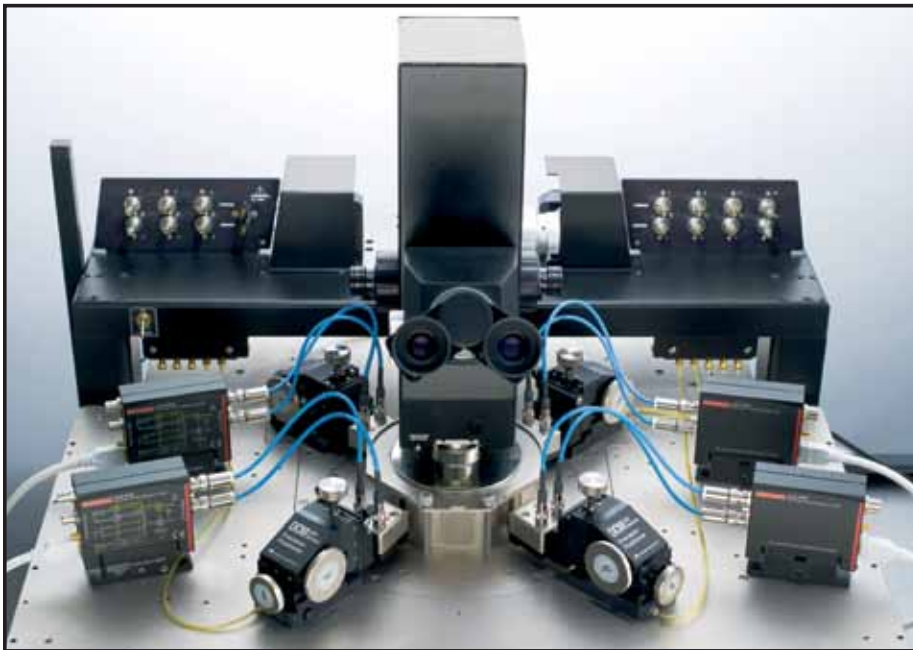

Each Model 4200-SCS chassis can accommodate up to four Model 4225-PMU modules to provide up to eight ultra-fast source and measure channels. Pictured are four 4225-RPM modules connected to a 4-pin probe.

1.888.KEITHLEY (U.S. only)

www.keithley.com

KEITHLEY

A GREATER MEASURE OF CONFIDENCE

Specifications are subject to change without notice.
All Keithley trademarks and trade names are the property of Keithley Instruments, Inc.
All other trademarks and trade names are the property of their respective companies.



A G R E A T E R M E A S U R E O F C O N F I D E N C E

KEITHLEY INSTRUMENTS, INC. ■ 28775 AURORA RD. ■ CLEVELAND, OH 44139-1891 ■ 440-248-0400 ■ Fax: 440-248-6168 ■ 1-888-KEITHLEY ■ www.keithley.com

BELGIUM

Sint-Pieters-Leeuw
Ph: 02-3630040
Fax: 02-3630064
info@keithley.nl
www.keithley.nl

CHINA

Beijing
Ph: 86-10-8447-5556
Fax: 86-10-8225-5018
china@keithley.com
www.keithley.com.cn

FRANCE

Saint-Aubin
Ph: 01-64532020
Fax: 01-60117726
info@keithley.fr
www.keithley.fr

GERMANY

Germering
Ph: 089-84930740
Fax: 089-84930734
info@keithley.de
www.keithley.de

INDIA

Bangalore
Ph: 080-26771071, -72, -73
Fax: 080-26771076
support_india@keithley.com
www.keithley.com

ITALY

Peschiera Borromeo (Mi)
Ph: 02-5538421
Fax: 02-55384228
info@keithley.it
www.keithley.it

JAPAN

Tokyo
Ph: 81-3-5733-7555
Fax: 81-3-5733-7556
info.jp@keithley.com
www.keithley.jp

KOREA

Seoul
Ph: 82-2-574-7778
Fax: 82-2-574-7838
keithley@keithley.co.kr
www.keithley.co.kr

MALAYSIA

Penang
Ph: 60-4-643-9679
Fax: 60-4-643-3794
sea@keithley.com
www.keithley.com

NETHERLANDS

Gorinchem
Ph: 0183-635333
Fax: 0183-630821
info@keithley.nl
www.keithley.nl

SINGAPORE

Singapore
Ph: 65-6747-9077
Fax: 65-6747-2991
sea@keithley.com
www.keithley.com

SWITZERLAND

Zürich
Ph: 044-8219444
Fax: 044-8203081
info@keithley.ch
www.keithley.ch

TAIWAN

Hsinchu
Ph: 886-3-572-9077
Fax: 886-3-572-9031
info_tw@keithley.com
www.keithley.com.tw

UNITED KINGDOM

Theale
Ph: 0118-9297500
Fax: 0118-9297519
info@keithley.co.uk
www.keithley.co.uk