

KickStart

DATA SHEET

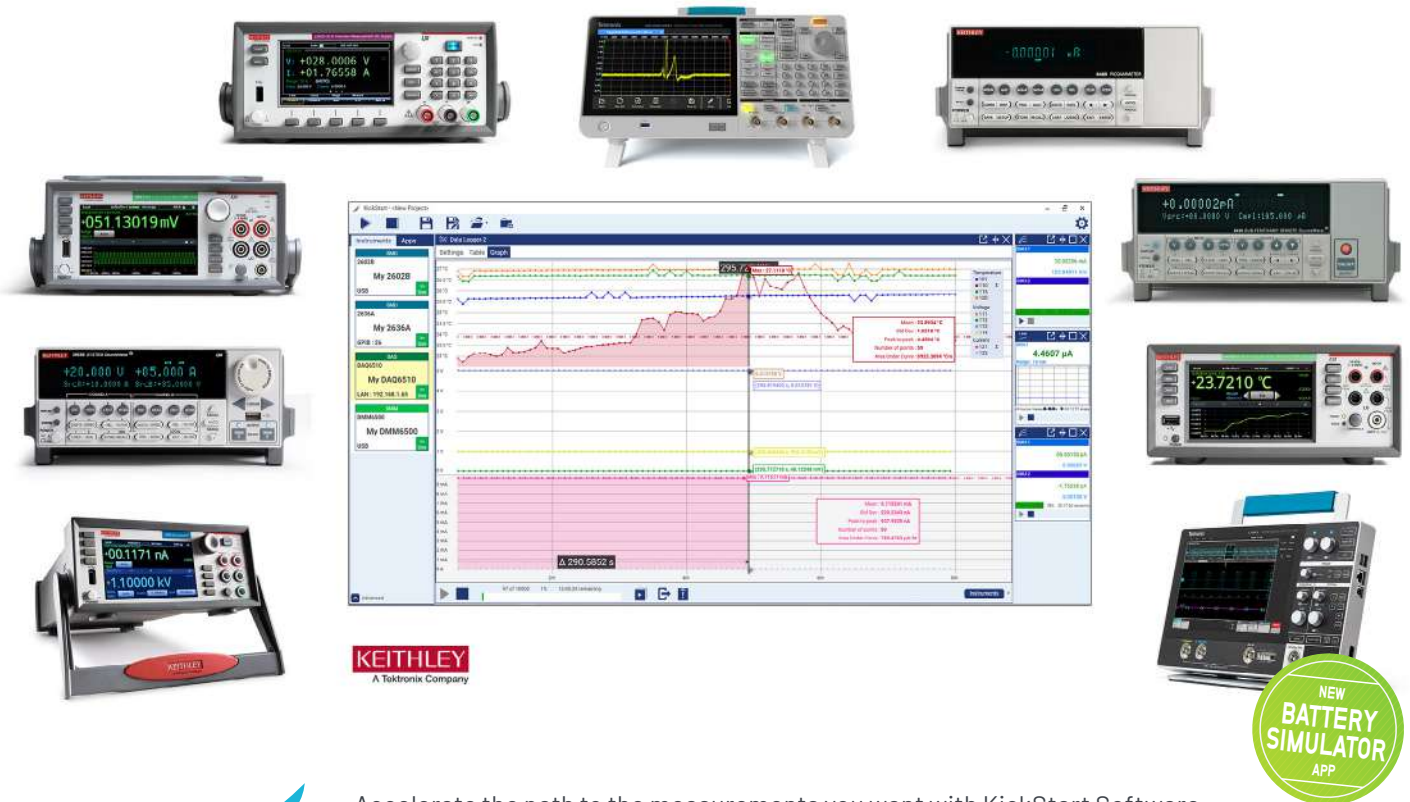

Accelerate the path to the measurements you want with KickStart Software. KickStart simplifies what you need to know about the instrument so that in just minutes you can take the instrument out of the box and get real data on your device. By plotting data immediately and offering quick statistical summaries of the data in the reading table, KickStart allows you to gather insights faster and make the decisions you need to move on to the next stage of device and product development. KickStart saves you time by facilitating quick replication of tests and comparison of results using convenient export features. With KickStart, you can focus on interpreting the test results so that your team can meet their innovation goals.

Key Features

KickStart Software for the PC enables quick test setup and data visualization when using multiple instruments.

- Save time by automating data collection of millions of readings.
- Set up a multi-instrument test with the ability to independently control up to eight instruments.
- Supports source measure unit (SMU) instruments, DMMs, power supplies, oscilloscopes, arbitrary function generators (AFGs), dataloggers, and sensitive instruments.
- Replicate tests quickly using saved test configurations.
- Use built-in plotting and comparison tools to quickly discover measurement anomalies and trends.
- Auto-export data in ready-to-use .csv and .xlsx formats for reports and additional analysis.

Applications

- Device characterization: Characterize materials and discrete components and verify design of electronic modules.
- Datalogging: Reliably log data to the PC; useful for testing device compliance to regulatory or industrial standards.
- Specialty applications: Battery testing and high resistivity measurements.

Minimized Time to Results

Connect your instrument to your PC and have KickStart discover your instrument in seconds. KickStart supports instruments connected using GPIB, LAN, and USB interfaces. With a simple drag of the mouse, launch an app to control and collect data from an instrument. KickStart can collect millions of readings from each instrument, which makes it a great solution for your long-term datalogging needs, for capturing transient events with a digitizing DMM, I-V characterization with SMUs, capturing waveforms with oscilloscopes, and now for generating signals with arbitrary function generators. KickStart presents the data in tabular and graphical formats. In the table, KickStart presents a statistical summary of the data in each column. You can hide non-essential data, and the statistics automatically update to reflect only data visible in the table. This can be quite useful for applications in which you want to monitor devices after they have reached thermal stabilization.

KickStart provides a test solution even when your tests involve the control of multiple instruments. You can launch and run up to eight apps at the same time. You can see results from multiple instruments in a single easy-to-view format.

Time (s)	Resistance (Ω) 101	Resistance (Ω) 102	Resistance (Ω) 103	Resistance (Ω) 104	Resistance (Ω) 105	
56	1.028459e+6	1.003070e+3	205.2355	4.751206e+3	19.00155e+3	
57	16.164916	1.029070e+6	1.003070e+3	205.2350	4.751270e+3	19.00170e+3
58	16.453456	1.029005e+6	1.003070e+3	205.2344	4.751285e+3	19.00142e+3
59	16.741992	1.028453e+6	1.003071e+3	205.2349	4.751206e+3	19.00151e+3
60	17.030528	1.028440e+6	1.003071e+3	205.2348	4.751278e+3	19.00175e+3
61	17.319064	1.028378e+6	1.003071e+3	205.2348	4.751268e+3	19.00140e+3
62	17.607600	1.028300e+6	1.003071e+3	205.2348	4.751285e+3	19.00153e+3
63	17.896136	1.028404e+6	1.003071e+3	205.2351	4.751267e+3	19.00165e+3
64	18.184672	1.028209e+6	1.003070e+3	205.2343	4.751264e+3	19.00134e+3
65	18.473208	1.028364e+6	1.003071e+3	205.2353	4.751285e+3	19.00149e+3
66	18.761744	1.028198e+6	1.003071e+3	205.2340	4.751275e+3	19.00107e+3
67	19.050280	1.028305e+6	1.003071e+3	205.2348	4.751305e+3	19.00133e+3
68	19.338816	1.028395e+6	1.003070e+3	205.2350	4.751280e+3	19.00163e+3
69	19.627352	1.028407e+6	1.003070e+3	205.2347	4.751285e+3	19.00159e+3
70	19.915888	1.028320e+6	1.003072e+3	205.2348	4.751283e+3	19.00133e+3
71	20.204424	1.028401e+6	1.003072e+3	205.2352	4.751282e+3	19.00158e+3
Min	0.00000	1.028138e+6	1.003069e+3	205.2340	4.751207e+3	19.00130e+3
Max	20.2058	1.031195e+6	1.003075e+3	205.2395	4.751303e+3	19.00179e+3
Mean	10.1031	1.029230e+6	1.003070e+3	205.2352	4.751282e+3	19.00137e+3
StdDev	3.95789	468.1030	888.3387e-6	797.2339e-6	7.281272e-3	119.1568e-3

View data in the reading table in an easy to read format. Hide rows or columns to show only relevant data.

Min	0.00000	1.028138e+6	1.003069e+3	205.2340
Max	20.2058	1.031195e+6	1.003075e+3	205.2395
Mean	10.1031	1.029230e+6	1.003070e+3	205.2352
StdDev	3.95789	468.1030	888.3387e-6	797.2339e-6

KickStart calculates basic statistics for each column of data visible in the table.

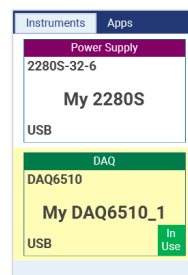

KickStart quickly discovers all connected instruments and allows you to create tests and view data even when instruments are not connected to the PC.

Faster Insights into Data

KickStart plots your data immediately so that you can quickly discover anomalies or trends and make the needed decisions to get you to the next phase of development of your material, device, or module. Getting insights quickly is most important, so a large portion of the viewing area is dedicated to the graph. There are built-in tools to compare and overlay data from previous test runs. You can mark or highlight points of interest in the graph and use cursors to view detail on multiple data series at once.



Data always gets prime focus in KickStart. Use the graph to discover measurement trends or anomalies.

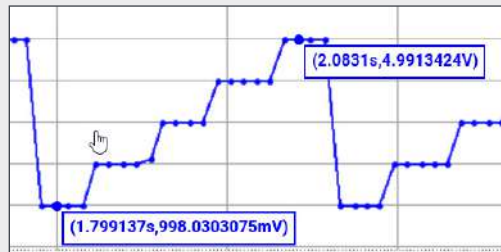

Use markers to highlight points of interest on the graph.

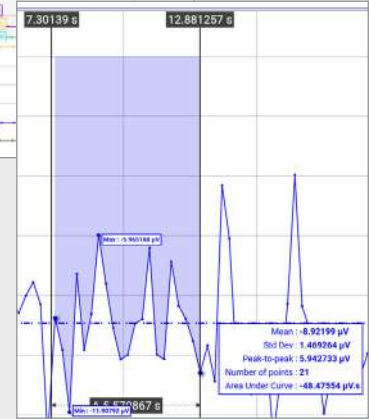

Use cursors to get information on multiple data series or to calculate differences on the horizontal scale.

Peace of Mind. Confidence. Reliability.

Proving that your device or module complies with industrial and regulatory standards is an important part of ensuring that your device or electronic module will meet your customer's requirements. Safe archival of test data is essential in compliance testing. KickStart streams and auto-exports data in .csv and .xlsx formats from the instrument to PC storage media, so, even in the event of a power outage, your data-logging data is preserved.

Additionally, you can save any test project that you create to re-use later or to share with others. This allows you to replicate tests easily at other locations, which is essential when you work on a global development team.

KickStart even allows you to prepare your tests using simulated instruments so that you are ready to test once the actual instrument arrives. You can quickly swap the actual instrument in your test configuration later. The use of simulated instruments also allows offline viewing of the data and test setup.

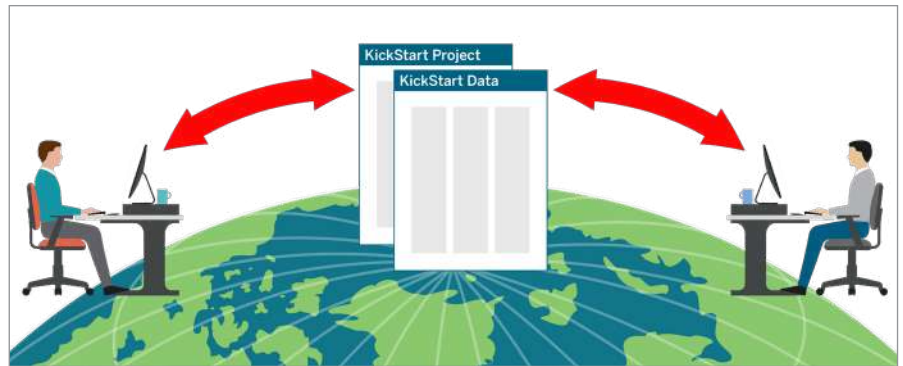

Save tests and share data for easy collaboration between multiple development sites.

Available KickStart Apps

SUITE APPS



AFG



Data Logger



DMM



I-V Characterizer



Power Supply



Scope

SPECIALTY APPS



Battery Simulator



High Resistivity



I-V Tracer

AFG App

The KickStart AFG App gives users a simple method to control the AFG by sourcing and previewing waveforms remotely. Use the AFG App in conjunction with other KickStart apps, such as the Scope App, to capture signal data.

- Total remote control of the basic AFG functions and parameters
- Ability to control both channels of multi-channel AFGs independently
- Access to a variety of standard waveforms including Sine, Square, Pulse, Noise, Arbitrary, Exponential Rise, and many more

- Multiple run modes including Continuous, Modulation, Sweep, and Burst settings
- Supports all Tektronix AFG31000 models
- Capture, Save, and Export waveform settings
- Ability to load in arbitrary waveforms remotely from AFG memory or file data on customer PC
- Responsive user interface to change settings in real time
- Easy-to-use app with settings on one page to reduce user error

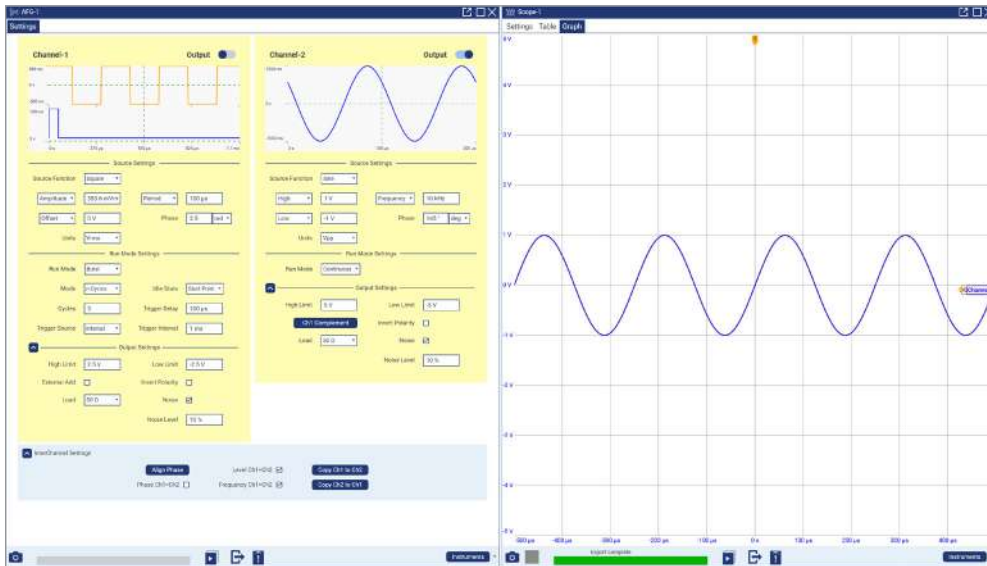

Use the Scope App to capture data sourced using the AFG App

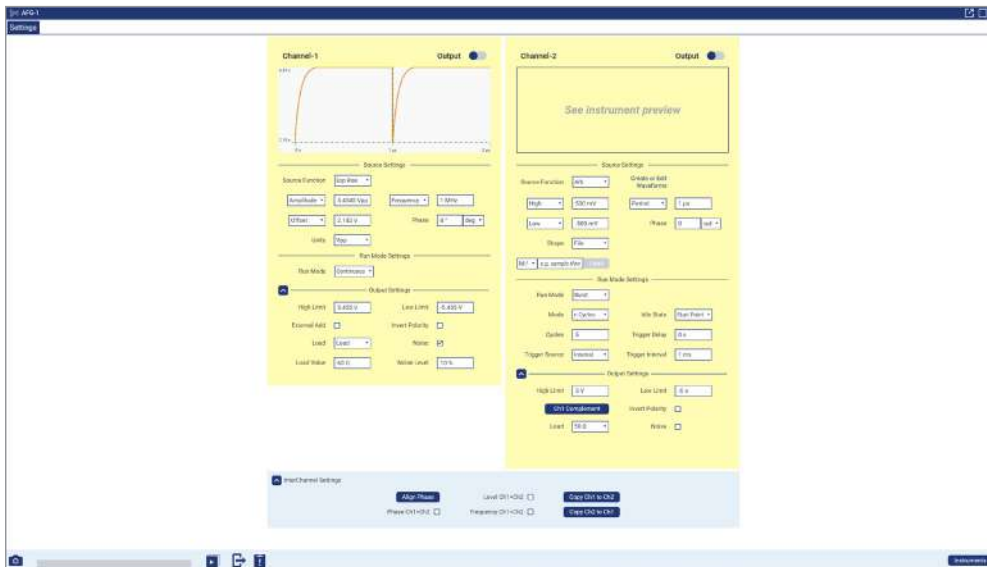

Control channels independently using a variety of source functions

Precision Digital Multimeter App

This app affords you a simple way to log data using your Keithley DMM or sensitive measurement instrument.

- Automate long-term datalogging.
- Plot and inspect waveforms from the digitizer built into the DMM.
- Trigger digitizer on digital events or programmed analog levels.
- Continuous data streaming for digitizer operation using DMM7510 and DMM6500.
- Supports Keithley DMM7510, DMM6500, 2000, 2010, 2100, and 2110 DMMs.
- Supports 6485 and 6487 Picoammeters, and 6514 and 6517B Electrometers.

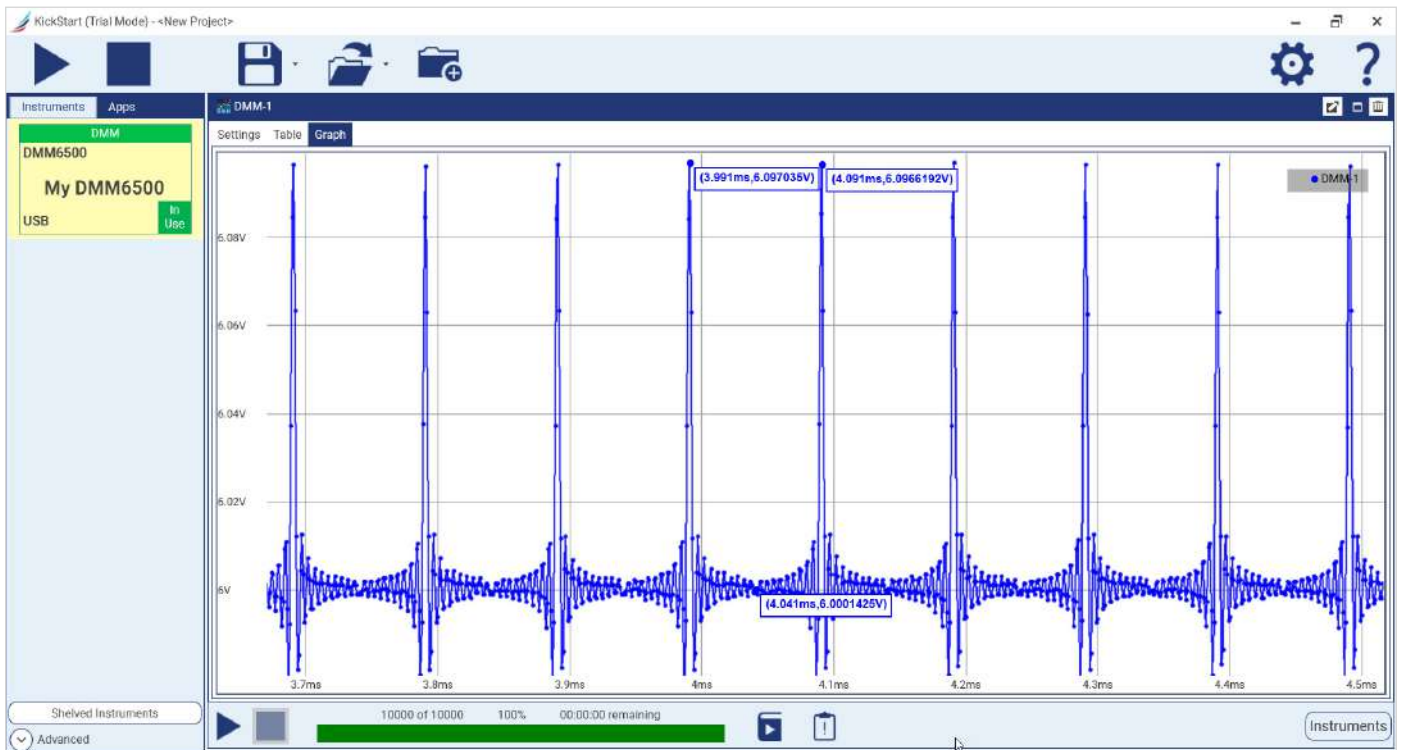

Capture waveforms with the DMM6500 Digitizing DMM using KickStart's Precision Multimeter App.

Data Logger App

Use the KickStart Data Logger App to set up and control your multi-channel data acquisition instrument. This app is designed to help you configure all your channels very quickly and even validate your connections during test configuration. It allows you to set up multiple channels with the same configuration but give each channel a meaningful label so that you can quickly scan your results and grab the information you need. Configure pass/fail limits for each channel in order to set alarm conditions and obtain quick visual verification of test results.

- Stream millions of readings to PC storage media for safe data archival.
- View multiple measurement functions in a single data window using stacked graphs.
- Plot measurement data versus another channel or versus time.
- Automatically export data in ready-to-use formats for reports and additional analysis even while the test is running.
- Supports Keithley DAQ6510, 2700, 2701, 2750, and 3706A.

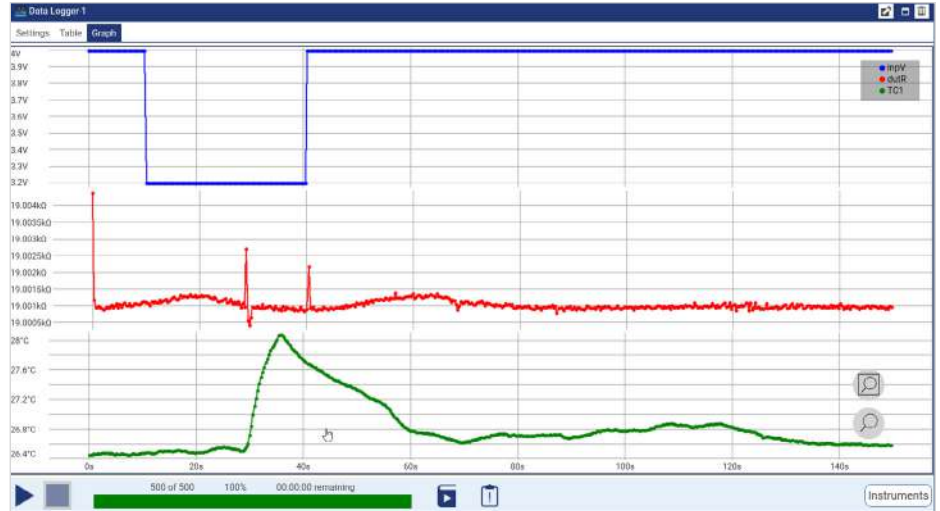

Plot and view multiple channels in a single graph with KickStart's Data Logger App.

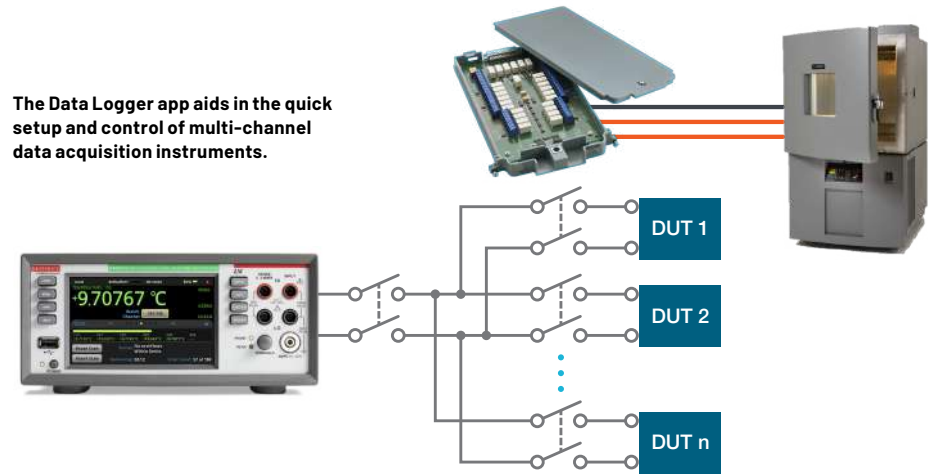

The Data Logger app aids in the quick setup and control of multi-channel data acquisition instruments.

Channels	E
<input checked="" type="checkbox"/> 101	inpV
<input type="checkbox"/> 102	102
<input type="checkbox"/> 103	103
<input type="checkbox"/> 104	104
<input checked="" type="checkbox"/> 105	dutR

Create personalized labels for each channel of your data logging switch card.

I-V Characterizer App

Use the I-V Characterizer App to perform current vs. voltage (I-V) test on a variety of materials, two-terminal and multi-terminal semiconductor devices, solar cells, and much more. You can configure each SMU for a variety of bias and sweep sourcing operations, including linear, log, list, and dual sweeps.

- Configure and control up to four SMU instruments for DC or Pulsed I-V test in either the same app, same project, or a combination of the two.
- Create tests by mixing any of these SMU instruments: 2400 Graphical Series, 2400 Standard Series (DC only), 2600B Series, 2651A, 2657A, and 6430 SourceMeter® SMU (DC only) instruments.
- Test heat-sensitive devices like vertical cavity surface emitting lasers (VCSEL) used in LIDAR and facial recognition with 2601B-Pulse System SourceMeter 10 μsec Pulser/Source Measure Unit Instrument.
- Differentiate SMU instrument channels and their measurement data using labels that are relevant to your device or module.
- Use built-in comparison tools to compare and overlay multiple test runs in a single graph.

Download Keithley’s Source Measure Unit (SMU) Selector Guide to choose the right SMUs for your application.



Create current vs. voltage characteristics for 2-terminal, 3-terminal, and 4-terminal devices.

Channel	Instrument
Gate	2450 my Gate SMU
Drain	2460 my Drain SMU
Bias 1	2602B my 2602B SMUs
Bias 2	

Add Channel

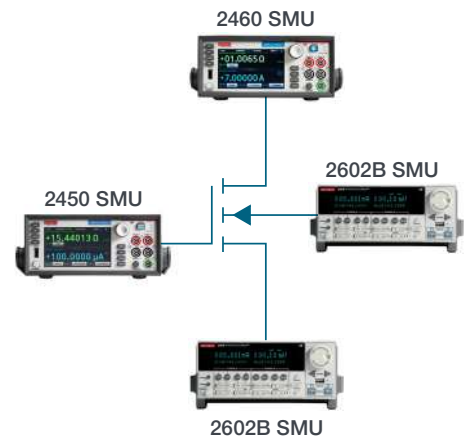

Characterize devices using up to four of Keithley’s SourceMeter SMU instruments.

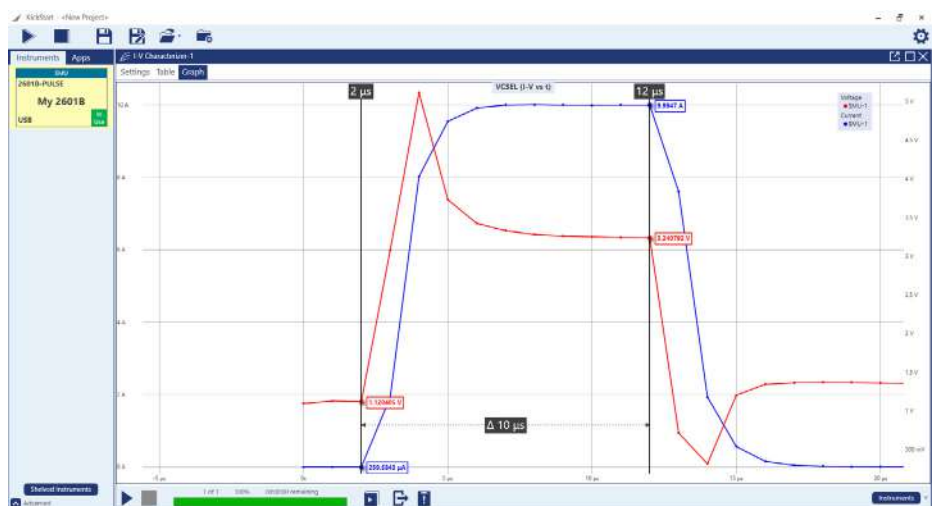

VCSEL Screenshot I-V-T for pulsing capability added in KickStart software to support the 2601B-Pulse SMU.

Power Supply App

This app simplifies supplying power to your device or system.

- Ability to control channels independently on multi-channel power supplies in both list sweep and bias modes.
- Quickly set up automated tests using bias or list sweep mode.
- List sweep mode capability for all supported models including those without the list sweep capabilities built-in the instrument.
- Interactively control bias conditions while monitoring measurements on another instrument.
- Use along with the Precision Multimeter App for an application such as power consumption analysis or monitoring load current stability.
- Supports the following Keithley power supplies: 2280S-32-6, 2280S-60-3, 2281S-20-6, 2220 Series, 2230 Series, 2231A-30-1, 2260B Series, 2200 Series, and 2306-LAN.
- Export/save statistics with data.

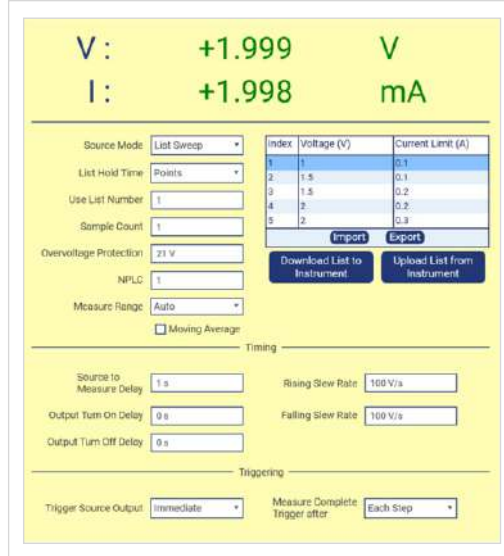

Create and download list sweeps of up to 99 points on the power supply.



View and set the most essential parameters on the power supply in KickStart's minimized view.

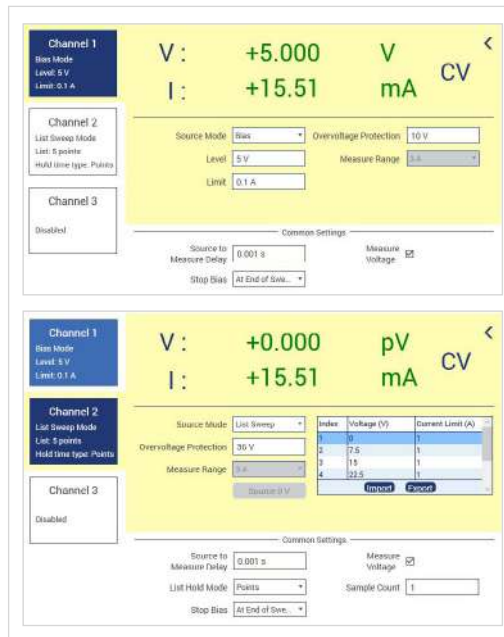

Control channels individually on multi-channel power supplies.

Scope App

Use the Scope app for data capture and datalogging of waveforms, measurements, and screenshots. This app offers three modes of operation.

- **Waveforms Mode:** KickStart retrieves the x-y data of each desired channel from the scope. It lists the data in the Table tab and a data plot in the Graph tab for the user to verify that the data retrieved is desired. Only data from analog channels is retrieved.
- **Measurements Mode:** The user can select up to 8 measurements to retrieve from the scope. The measurements are made by the oscilloscope and logged into the KickStart Table. The user can use the Graph tab in KickStart to view the measurement data and easily note trends or spot anomalies.
- **Screenshot Mode:** Capture the screen image of the oscilloscope.

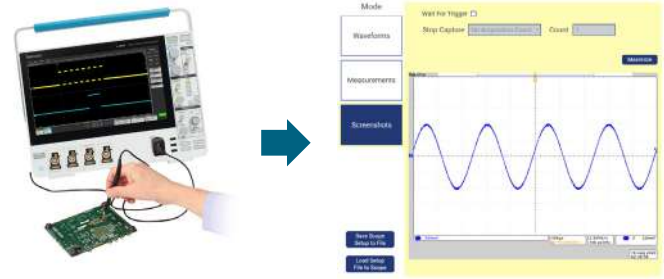

Saved screen capture of scope with KickStart.



The setup window enables the selection of the Waveforms, Measurements, or Screenshots mode.

The Scope app supports data retrieval from Analog Channels, Reference Channels and Math Channels. The app will either capture present data (without waiting for a trigger) or will arm the scope to wait for a trigger, stop the capture to gather data once scope has been triggered and re-arm scope to wait for next trigger after data is captured.

The scope app supports the following Tektronix oscilloscopes: TBS1000 Series, TBS2000 Series, 2 Series MSO, 3 Series MD0, 4 Series MSO, 5 Series MSO, 5 Series B MSO, 5 Series MSO Low Profile, 6 Series B MSO, MD03000 Series, MD04000 Series, MSO3000 Series, MSO4000 Series, DPO3000 Series, DPO4000 Series, TDS1000 Series, TDS2000 Series, and TDS200 Series.

Time (s)	Channel 1 Voltage (V)	Channel 2 Wdgpts (V)
1	-0.00000e+0	140.0000e-3
2	-1.99960e-3	140.0000e-3
3	-1.89920e-3	140.0000e-3
4	-1.79880e-3	140.0000e-3
5	-1.69840e-3	140.0000e-3
6	-1.59800e-3	140.0000e-3
7	-1.49760e-3	140.0000e-3
8	-1.39720e-3	140.0000e-3
9	-1.29680e-3	140.0000e-3
10	-1.19640e-3	140.0000e-3
11	-1.09600e-3	140.0000e-3
12	-1.09560e-3	140.0000e-3
13	-1.09520e-3	140.0000e-3
14	-1.09480e-3	140.0000e-3
15	-1.09440e-3	140.0000e-3
16	-1.09400e-3	140.0000e-3
17	-1.09360e-3	140.0000e-3
18	-1.09320e-3	140.0000e-3
19	-1.09280e-3	140.0000e-3
20	-1.09240e-3	140.0000e-3
21	-1.09200e-3	140.0000e-3
22	-1.09160e-3	140.0000e-3
23	-1.09120e-3	140.0000e-3
24	-1.09080e-3	140.0000e-3
25	-1.09040e-3	140.0000e-3
Min	-0.00000e+0	-1.30000e-3
Max	1.99960e-3	1.00000e-3
Mean	-200e-9	-64.10000e-3
StdDev	1.15470e-3	719.4000e-3

Data collected from the scope can be displayed in Table View with statistics.

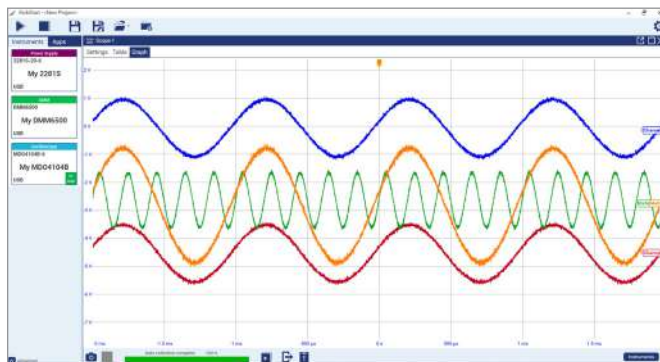

Display up to 4 channels of analog data, including Reference and Math channels.

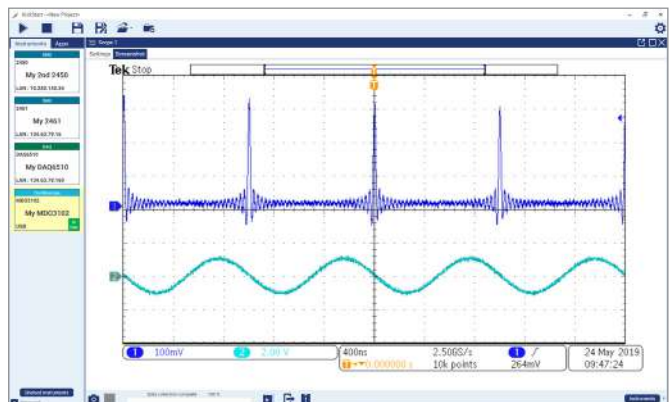

Capture and save a screenshot image for use in reports and journal.

Battery Simulator App

The KickStart Battery Simulator App gives users a simple method to create, manage, and simulate battery models along with the ability to cycle test batteries. This optional specialty application for KickStart software is designed for use with Keithley’s 2281S Power Supply/Battery Simulator for simulating battery models, the Keithley 2380 DC Electronic Load for battery model generation, and the Keithley 2400 Graphical Series and 2600A/B Series SMUs (channel A only) for battery model generation, battery simulation, and battery charge/discharge cycle testing.

The Battery Simulator App includes:

- Ability to generate, edit, and simulate custom battery models.
- Responsive user interface allows changes to the simulated state of charge in real time.
- Table and graph views to visualize data collection in real time.
- Ability to browse multiple battery models saved to repository on local drive.
- Ability to import and export models to and from KickStart software.
- Dynamic and static battery models.
 - Dynamic battery model updates values in real time.
- Visual representation of battery VOC, Vt, SOC, ESR, current, and capacity.
- Ability to test batteries through multiple charge and discharge cycles with access to a myriad of test cutoff conditions.
- “One box” simulator, model generator, and cycle testing solution using SMUs.

The Battery Simulator Application is a specialty KickStart App and is sold separately. Please refer to the Ordering Information section for details on available licenses.

Do not connect a battery to the instrument prior to opening the Battery Simulator App and selecting the mode you wish to operate. This will ensure that the SMU is in the proper Output Off State before connecting to a battery.



The Battery Simulator App allows users to simulate battery models and monitor key parameters in real time.

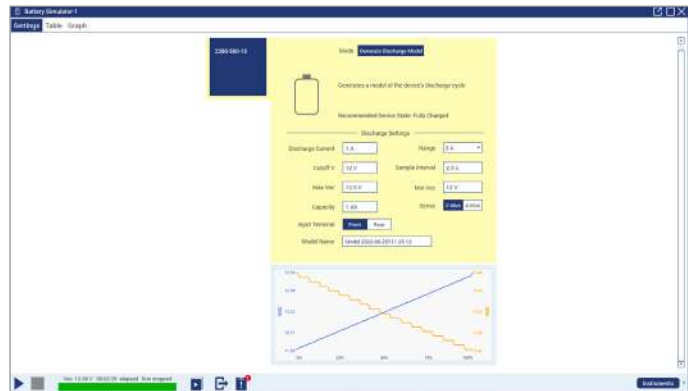

Generate and save new custom battery models with a single mouse click.



Cycle Test Batteries using constant current, constant voltage, or hybrid CC + CV charge.

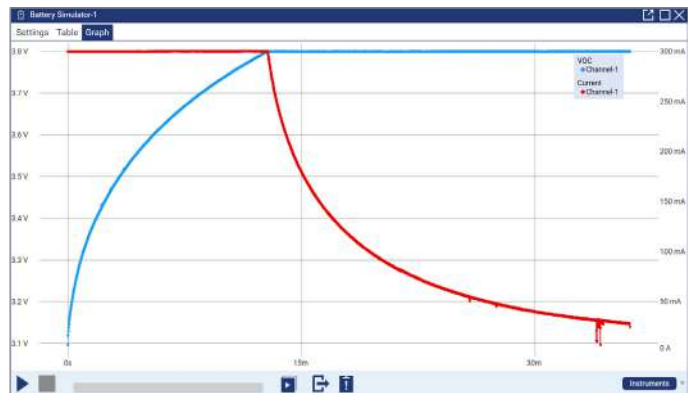

View VOC, Current, or ESR readings as they are collected during model generation.

High Resistivity App

The optional high resistivity application (HRMA) for KickStart is designed for use with Keithley’s 6517B Electrometer/High Resistance Meter. The 6517B along with the 8009 Resistivity Test Fixture is a laboratory standard for volume and surface resistivity measurements on insulating materials. Together, they can be used to measure resistance up to $10^{18} \Omega$ at up to 1000 V.

The KickStart high resistance measurement option makes it easier for you to:

- Quickly and reliably determine resistivity of material using tests that conform to ASTM D257 standard.
- Perform a Step Response test to identify electrification time appropriate to the material’s time constant.
- Observe resistivity dependence on temperature and relative humidity of environment using optional probes 6517-TP and 6517-RH.
- Use the alternating polarity measurement technique to eliminate inherent background currents for the most accurate resistivity measurements.

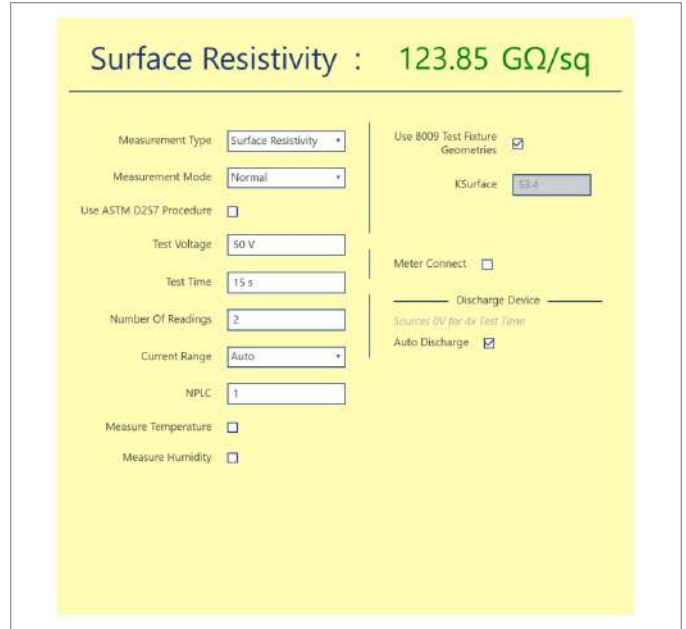

Set up a High Resistivity Test from a single window.

The KickStart High Resistivity Application requires a license: either the KICKSTARTFL-HRMA2 floating perpetual license or the KICKSTARTFL-HRMA2-AN 1-year subscription. A floating license allows selected users to manage transfer of individual license to different PCs.

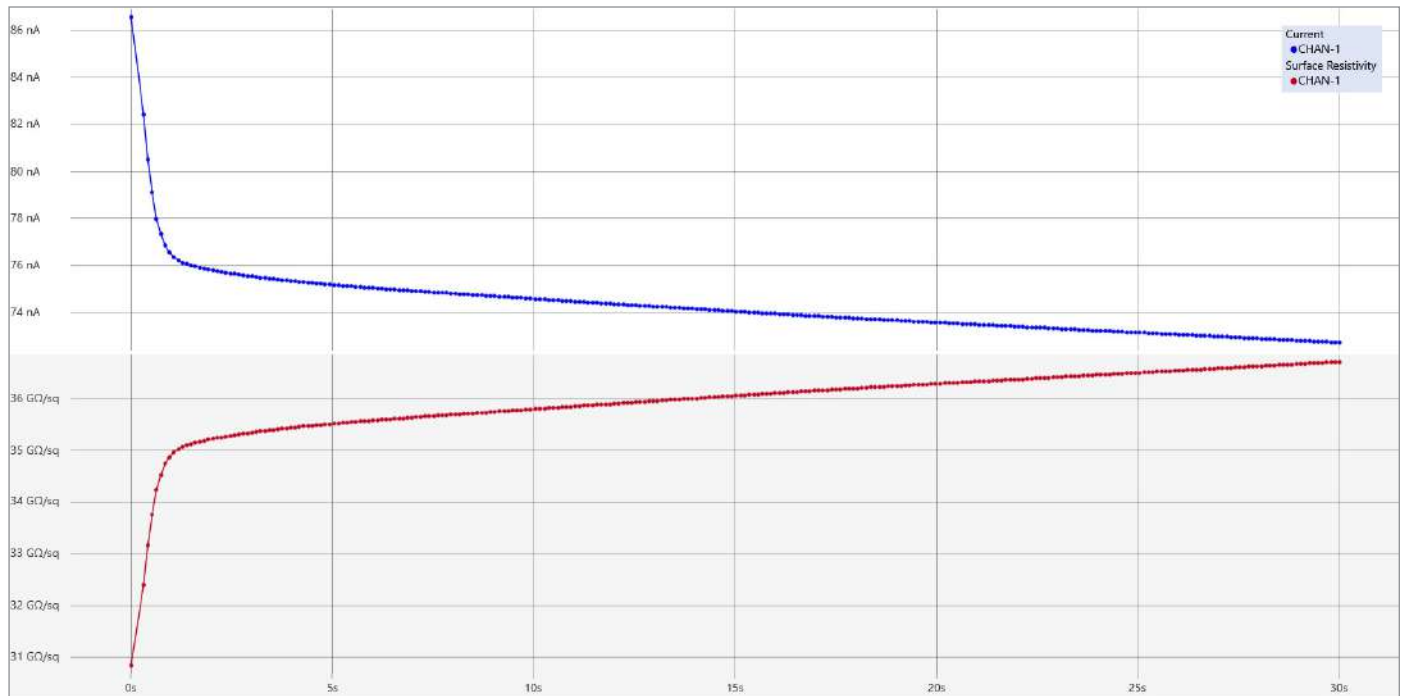

View Step Response in real time.

I-V Tracer App

Keithley I-V Tracer Software leverages the unique touchscreen interface of the Graphical 2400 Series SourceMeter SMU instruments to recreate the familiar user experience of a curve tracer for two-terminal devices. Adding the I-V Tracer software to your SourceMeter instrument gives you a dedicated user interface for tracing the characteristics of your devices through both current and voltage. With a range of compatible instruments, I-V Tracer can utilize the full capabilities of each source measure unit, including the dual high-speed digitizers of the 2461 to perform tracing with AC polarity and pulsed DC in addition to standard DC polarity.



- Compatible with Keithley 2450, 2460, 2461, and 2470 Graphical SourceMeter SMUs
- +DC, -DC, AC polarity modes (AC mode only compatible with the 2461 SMU)
- Compare mode to display a reference device next to a measured curve
- Save curve data to disk with KickStart for analysis in Excel
- Screen capture curves
- Pinch and zoom on the touchscreen to analyze data immediately
- Current sourcing capabilities allowing the user to sweep current across the device and plot current versus voltage

I-V Tracer Software is a specialty KickStart App and is sold separately. Please refer to the Ordering Information section for details on single, three, or five license packs.



I-V Tracer Software offers a modern alternative to traditional curve tracers.



Use the front panel knob to see your data more clearly.



Using I-V Tracer Software means engineers no longer need to share outdated equipment.



I-V Tracer offers an ideal engineering teaching solution.

Ordering Information

KickStart Software Suite Bundle Licenses (includes all Suite Applications in one license)

KICKSTARTFL-SUITE	KickStart Instrument Control Software; Perpetual Floating License Option*
KICKSTARTFL-SUITE-UP	KickStart Instrument Control Software; Annual Maintenance License for extending support of the Perpetual Floating License Option*
KICKSTARTFL-SUITE-AN	KickStart Instrument Control Software; 1 year Subscription Floating License Option**

KickStart Software Individual Suite Applications Licenses

KICKSTARTFL-AFG	KickStart Arbitrary Function Generator Application Software; Perpetual Floating License Option*
KICKSTARTFL-AFG-UP	KickStart Arbitrary Function Generator Application Software; Maintenance License for extending support of the Perpetual Floating License Option*
KICKSTARTFL-AFG-AN	KickStart Arbitrary Function Generator Application Software; 1 year Subscription Floating License Option**
KICKSTARTFL-DL	KickStart Data Logger Application Software; Perpetual Floating License Option*
KICKSTARTFL-DL-UP	KickStart Data Logger Application Software; Maintenance License for extending support of the Perpetual Floating License Option*
KICKSTARTFL-DL-AN	KickStart Data Logger Application Software; 1 year Subscription Floating License Option**
KICKSTARTFL-DMM	KickStart Precision Digital Multimeter Application Software; Perpetual Floating License Option*
KICKSTARTFL-DMM-UP	KickStart Precision Digital Multimeter Application Software; Maintenance License for extending support of the Perpetual Floating License Option*
KICKSTARTFL-DMM-AN	KickStart Precision Digital Multimeter Application Software; 1 year Subscription Floating License Option**
KICKSTARTFL-IVC	KickStart I-V Characterizer Application Software; Perpetual Floating License Option*
KICKSTARTFL-IVC-UP	KickStart I-V Characterizer Application Software; Maintenance License for extending support of the Perpetual Floating License Option*
KICKSTARTFL-IVC-AN	KickStart I-V Characterizer Application Software; 1 year Subscription Floating License Option**
KICKSTARTFL-PS	KickStart Power Supply Application Software; Perpetual Floating License Option*
KICKSTARTFL-PS-UP	KickStart Power Supply Application Software; Maintenance License for extending support of the Perpetual Floating License Option*
KICKSTARTFL-PS-AN	KickStart Power Supply Application Software; 1 year Subscription Floating License Option**
KICKSTARTFL-SCOPE	KickStart Scope Application Software; Perpetual Floating License Option*
KICKSTARTFL-SCOPE-UP	KickStart Scope Application Software; Maintenance License for extending support of the Perpetual Floating License Option*
KICKSTARTFL-SCOPE-AN	KickStart Scope Application Software; 1 year Subscription Floating License Option**

KickStart Software Specialty Applications Licenses

KICKSTARTFL-BAT	KickStart Battery Simulator Application Software; Perpetual Floating License Option*
KICKSTARTFL-BAT-UP	KickStart Battery Simulator Application Software; Annual Maintenance License for extending support of the Perpetual Floating License Option*
KICKSTARTFL-BAT-AN	KickStart Battery Simulator Application Software; 1 year Subscription Floating License Option
KICKSTARTFL-HRMA2	KickStart High Resistivity Application Software; Perpetual Floating License Option*
KICKSTARTFL-HRMA2-UP	KickStart High Resistivity Application Software; Annual Maintenance License for extending support of the Perpetual Floating License Option*
KICKSTARTFL-HRMA2-AN	KickStart High Resistivity Application Software; 1 year Subscription Floating License Option**
KICKSTARTNL-ACT1	Single license I-V Tracer App pack for one source measure unit
KICKSTARTNL-ACT3	Single license I-V Tracer App pack for three source measure units
KICKSTARTNL-ACT5	Single license I-V Tracer App pack for five source measure units

* Perpetual Licenses: The software can be used indefinitely; license does not expire but updates/support only available for the first 12 months. Support can be extended by purchasing a maintenance license. If a perpetual license goes out of support, all features will be frozen to the last released version before the support expired. The software will continue to work, but you cannot get any updates newer than the support expiration date.

- Maintenance Licenses – Apply to perpetual licenses only. Maintenance license is an extension license that extends the period of support of an original perpetual license for 12 months.

** Subscription Licenses: The software can be used throughout the term of the license only. Software updates and support through the term of the license are included. When the Subscription license expires, all features will no longer work, but a new Subscription license may be purchased.

Download the latest version of KickStart today from www.tek.com/keithley-kickstart

KickStart allows you to create tests and view, manipulate and export data without a license. To communicate with and control an instrument, KickStart requires a license. KickStart installs with a one-time free trial license. Visit tek.com to get a quote for KICKSTARTFL-SUITE, a floating license that unlocks all the KickStart suite apps. A floating license allows selected users to manage transfer of individual license files to different PCs. License management is done through the Tektronix Asset Management System (TekAMS).

For more info on TekAMS, visit <https://www.tek.com/products/product-license>. Each valid license entitles you to unlimited support by Tektronix' worldwide technical support centers and field applications engineers.

Learn More about KickStart

Visit www.tek.com/keithley-kickstart for the latest information about KickStart.

For questions, please visit Tektronix Technical Forums at <http://forum.tek.com> or contact your local Tektronix sales office noted on the back of this datasheet.

Recommended System Requirements

- CPU: Dual-core processor 2 GHz or better
- Memory: 8GB RAM
- Disk Drive: 8GB of free space
- Windows 11, 10, 8, 7 64-bit
- Instrument communication interfaces: USB, GPIB, LAN
- Display resolution: Minimum 1920×1080 recommended

Contact Information:

Australia 1 800 709 465
Austria* 00800 2255 4835
Balkans, Israel, South Africa and other ISE Countries +41 52 675 3777
Belgium* 00800 2255 4835
Brazil +55 (11) 3530-8901
Canada 1 800 833 9200
Central East Europe / Baltics +41 52 675 3777
Central Europe / Greece +41 52 675 3777
Denmark +45 80 88 1401
Finland +41 52 675 3777
France* 00800 2255 4835
Germany* 00800 2255 4835
Hong Kong 400 820 5835
India 000 800 650 1835
Indonesia 007 803 601 5249
Italy 00800 2255 4835
Japan 81 (3) 6714 3086
Luxembourg +41 52 675 3777
Malaysia 1 800 22 55835
Mexico, Central/South America and Caribbean 52 (55) 88 69 35 25
Middle East, Asia, and North Africa +41 52 675 3777
The Netherlands* 00800 2255 4835
New Zealand 0800 800 238
Norway 800 16098
People's Republic of China 400 820 5835
Philippines 1 800 1601 0077
Poland +41 52 675 3777
Portugal 80 08 12370
Republic of Korea +82 2 565 1455
Russia / CIS +7 (495) 6647564
Singapore 800 6011 473
South Africa +41 52 675 3777
Spain* 00800 2255 4835
Sweden* 00800 2255 4835
Switzerland* 00800 2255 4835
Taiwan 886 (2) 2656 6688
Thailand 1 800 011 931
United Kingdom / Ireland* 00800 2255 4835
USA 1 800 833 9200
Vietnam 12060128

* European toll-free number. If not accessible, call: +41 52 675 3777

Rev. 02.2022



Find more valuable resources at TEK.COM

Copyright © Tektronix. All rights reserved. Tektronix products are covered by U.S. and foreign patents, issued and pending. Information in this publication supersedes that in all previously published material. Specification and price change privileges reserved. TEKTRONIX and TEK are registered trademarks of Tektronix, Inc. All other trade names referenced are the service marks, trademarks or registered trademarks of their respective companies.

011824 SBG 1KW-60965-14

