

# Nano Series Automated Tuners

DATA SHEET / 4T-050G10

MODELS:  
NT-18G-50G-1C  
NT-18G-50G-1C-C

NANO5G IS THE INDUSTRY'S BEST AUTOMATED IMPEDANCE TUNER OPTIMIZED FOR LOAD PULL MEASUREMENTS AT 5G FR2 FREQUENCIES. HIGH VSWR. HIGH TUNING ACCURACY AND REPEATABILITY. DIRECT PROBE CONNECTION WITH NO VIBRATION. SMALLEST TUNER. NANO IS 5G.



## What is load pull?

Load Pull is the act of presenting a set of controlled impedances to a device under test (DUT) and measuring a set of parameters at each point. By varying the impedance, it is possible to fully characterize the performance of a DUT and use the data to:

- > Verify simulation results of a transistor model (model validation)
- > Gather characterization data for model extraction (behavioral model extraction)
- > Design amplifier matching networks for optimum performance (amplifier design)
- > Ensure a microwave circuit's ability to perform after being exposed to high mismatch conditions (ruggedness test)
- > Confirm the stability or performance of a microwave circuit or consumer product under non-ideal VSWR conditions (stability/performance/conformance/antenna test)

*Example of load pull measurements with Output Power (Pout) contours plotted on a Smith Chart.*

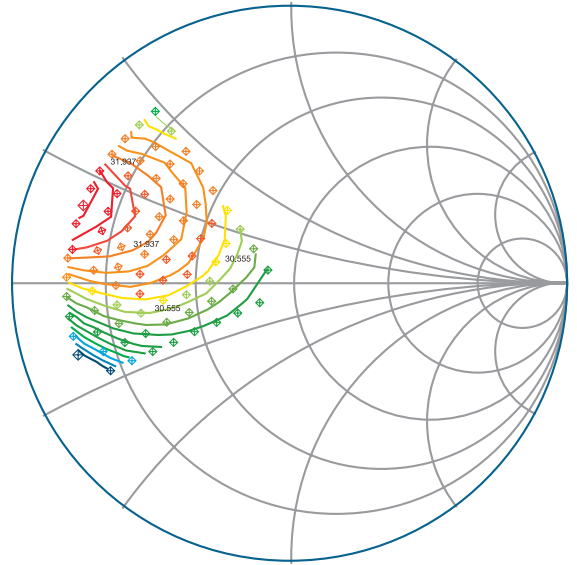

*Iso Pout Contours Measured @ 28 GHz*

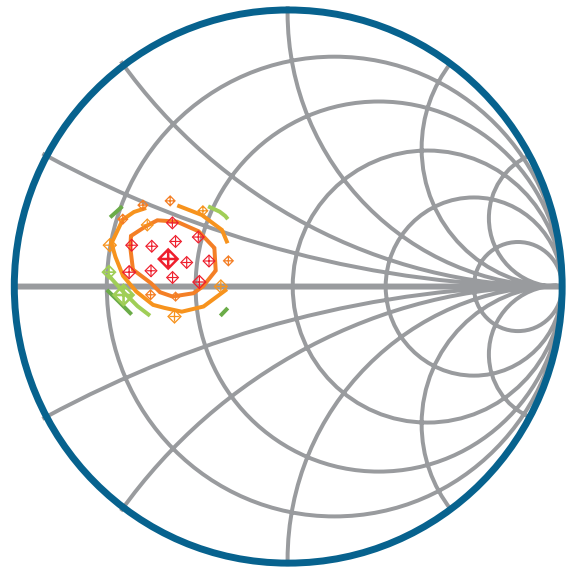

*Iso Pout Contours Simulated @ 28 GHz*

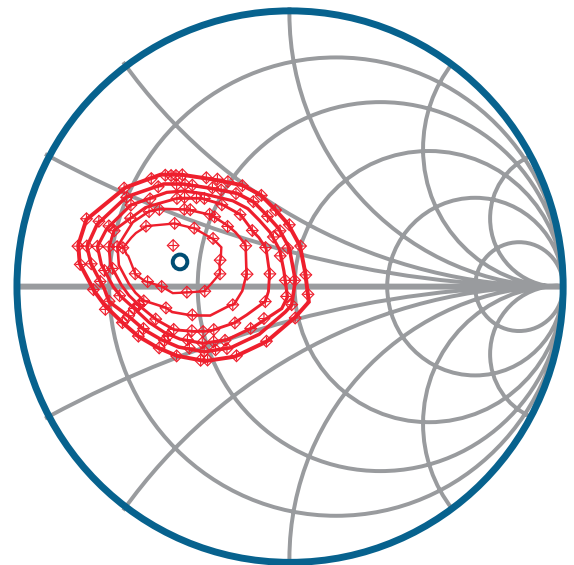

## Slide-Screw Impedance Tuner

One tool available to vary the impedances presented to a DUT is the slide-screw impedance tuner. The slide-screw tuner is based on a  $50\Omega$  slabline and a reflective probe, sometimes referred to as a slug. Ideally, when the probe is fully retracted, the tuner presents a near- $50\Omega$  impedance represented by the center of a normalized Smith Chart. As the probe is lowered into the slabline (Y-direction) it interrupts the electric field that exists between the center conductor and walls of the slabline, reflects some

of the energy back towards the DUT, creates a capacitance and increases the magnitude of reflection (represented by the red curve on the Smith Chart at right). As the probe travels along the slabline (X-direction), the distance between the probe and the DUT is altered, thereby rotating the phase of the reflection (represented by the blue curve on the Smith Chart). It is therefore possible to recreate nearly any arbitrary impedance without the need of discrete components (lumped elements or transmission lines).

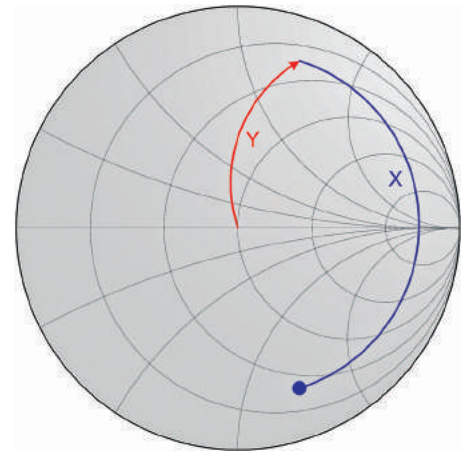

## Simplified representation of a slide-screw tuner.

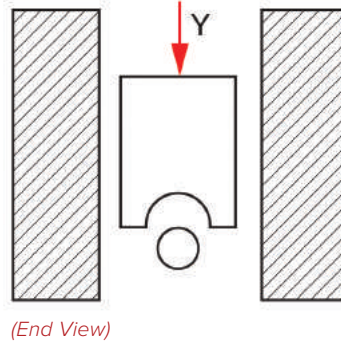
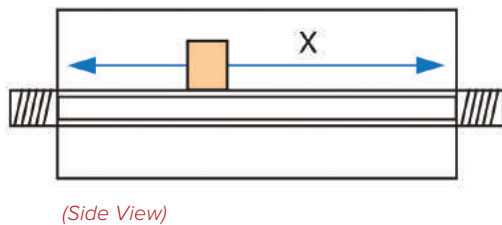

The probes used in slide-screw tuners are wideband in nature and have similar reflective properties over a wide range of frequencies. Each tuner employs at least one probe, and many models utilize two probes of varying dimensions to increase the overall useful bandwidth of the tuner.

In this manner, it is common for slide-screw tuners to achieve an overall frequency range of several octaves to over a decade.

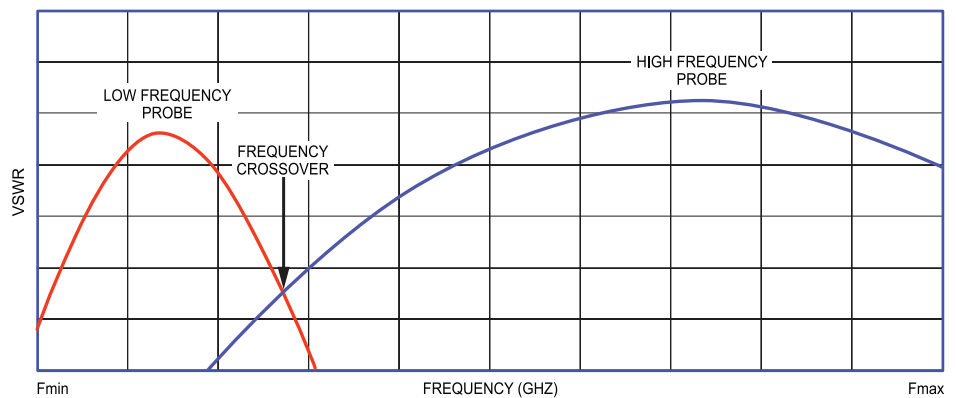

VSWR versus Frequency of a two-probe slide-screw tuner.

## Pre-Calibration (Pre-Characterization)

Slide-screw tuners are available in both manual and automated varieties. While they both work on the same slabline and capacitive probe technique, automated tuners have the ability to be pre-calibrated. Pre-calibration involves recording the s-parameters of each probe at varying X and Y positions for the frequencies of interest using a calibrated vector network analyzer. In general, X and Y positions are selected such that an even distribution of impedances are recorded over the Smith Chart. Once the calibration data is stored in a lookup table, the VNA is no longer required to use the tuner; the tuner 'knows' how to present impedances accurately without VNA verification.

## Tuner Repeatability

Tuner repeatability is defined as the vector difference between the pre-calibrated s-parameter data and subsequent s-parameter measurements after movement, when returning the probe to a given X and Y position. Since the impedances presented to the DUT are reliant on the tuner's ability to accurately return to pre-calibrated states, repeatability is a critical tuner characteristic that affects the reliability of measurement data. In order to guarantee a high level of repeatability, precision

mechanics and motors within the tuner are used to return the probe to its pre-calibrated positions with s-parameter vector differences of  $-40$  to  $-50$ dB or better (see specific tuner model pages 6 through 8 for typical repeatability graphs).

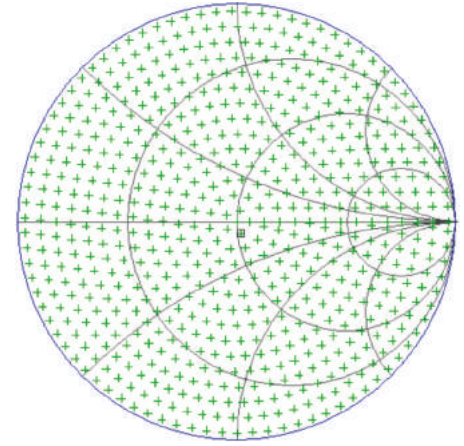

---

## Tuning Accuracy and Interpolation

During pre-calibration, the tuner's s-parameters are recorded at a user-definable number (normally between 300-3000) of X and Y positions giving an even distribution over the Smith Chart. However, an arbitrary load impedance that falls between pre-calibrated states might be required. To achieve a high level of accuracy, a two-dimensional algorithm is used to interpolate between the closest pre-calibrated impedances

in order to determine the new physical X and Y positions of the desired interpolated impedance. Interpolation increases the number of tunable impedances well beyond the initial pre-calibration range.

Given a sufficiently dense pre-calibration look-up table, a tuner's repeatability (ability to return to pre-calibrated states) and accuracy (ability to interpolate between pre-calibrated states) offer similar performances.

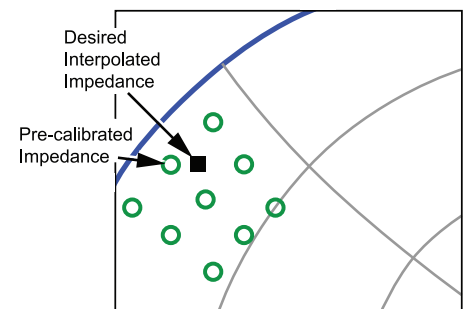

## Patented LXI™-Compliant Embedded Tuner Controller

(U.S. Patent No. 8,823,392)

All Maury slide-screw automated impedance tuners are equipped with a patented embedded LXI™-compliant controller (U.S. Patent No. 8,823,392) with onboard microprocessor and memory. After pre-calibration, the lookup table is copied onto the tuner's embedded flash memory storage, as are any s-parameter files of passive components that will be used with the tuner (adapters, cables,

fixtures, probes, attenuators...). The tuner's onboard microprocessor will use the lookup table and component s-parameter blocks to calculate the probe positions required to present an arbitrary load impedance taking into account (de-embedding) all adapter/fixture losses between the tuner and DUT, and all back-side losses between the tuner and the measurement instrument, as well as possible non-50Ω terminations.

An integrated web interface allows for easy point-and-click tuning. Simply open Internet Explorer, Firefox, Chrome or any

web browser in any operating system, and begin tuning. Capabilities include a graphic interface for de-embedded tuning at the DUT reference.

Direct ASCII commands can be sent through raw TCP/IP interface over Ethernet or USB and used with any socket programming language or through any Telnet client program in any operating system. Commands include direct impedance tuning, reference-plane shifting, VSWR testing and more.

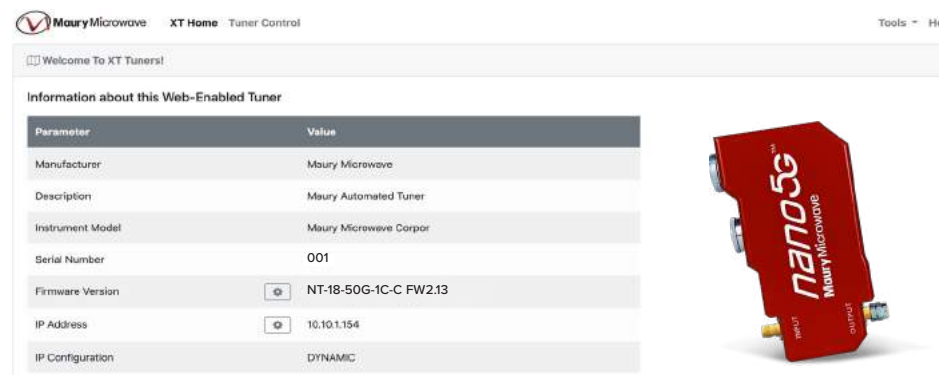
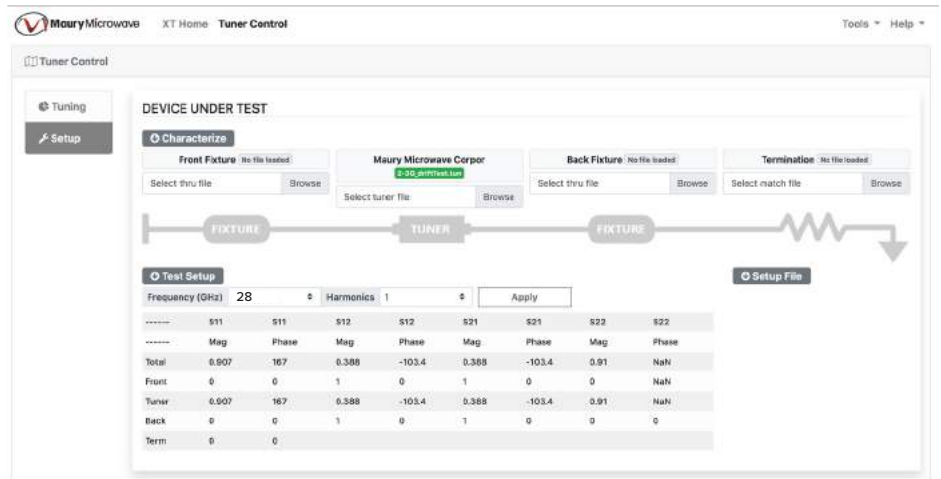
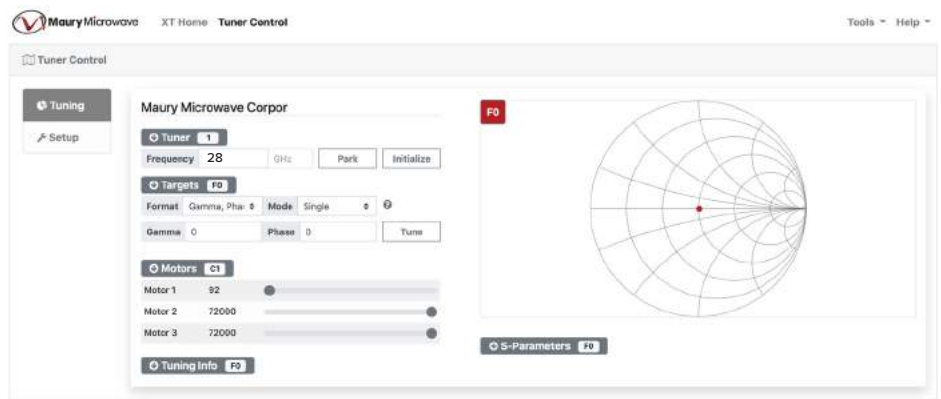

## Optimized for on-wafer integration

Nano-series automated impedance tuners have been optimized for on-wafer integration. At 1/10 the volume and 1/10 the weight\* of MT984 series, Nano-series tuners have been designed to directly connect to wafer probes thereby eliminating the need for short integration cables or probe mounts. The direct connection offers two advantages: maximizing VSWR at the DUT reference plane and minimizing phase skew at the DUT reference plane.

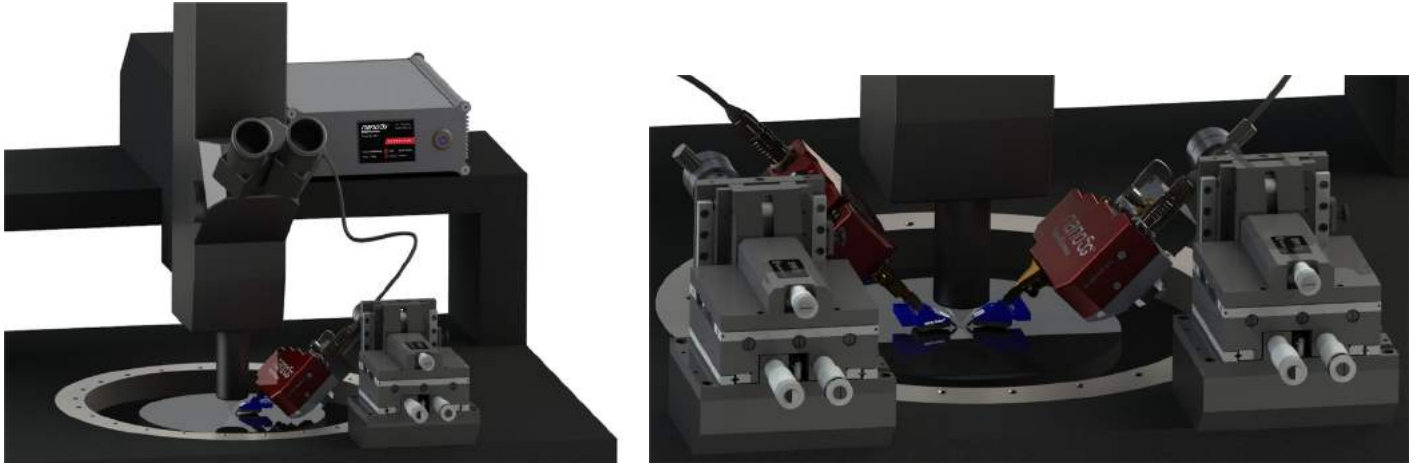

## Maximizing VSWR at DUT reference plane

The tuning range achievable at the DUT reference plane is determined by the tuning range of the tuner and the insertion losses of all components between the tuner and the DUT. The formula to calculate the net tuning range, shown as return loss (RL), is  $RL_{DUT} = RL_{tuner} + RL_{components}$ . Minimizing the insertion loss of the components between the tuner and the DUT reduces the return loss impact and maximizes the tuning range at the DUT. The Smith Charts below show two scenarios:

- > The yellow circle on the Smith Charts shows the net tuning range of a tuner with minimum VSWR of 16:1 at 28 GHz, probe mount and coupler insertion loss of 0.6 dB and wafer probe insertion loss of 0.4 dB.
- > The red circle on the Smith Chart shows the net tuning range of Nano5G with minimum VSWR of 40:1 at 28 GHz, probe insertion loss of 0.4 dB, but no probe mount.

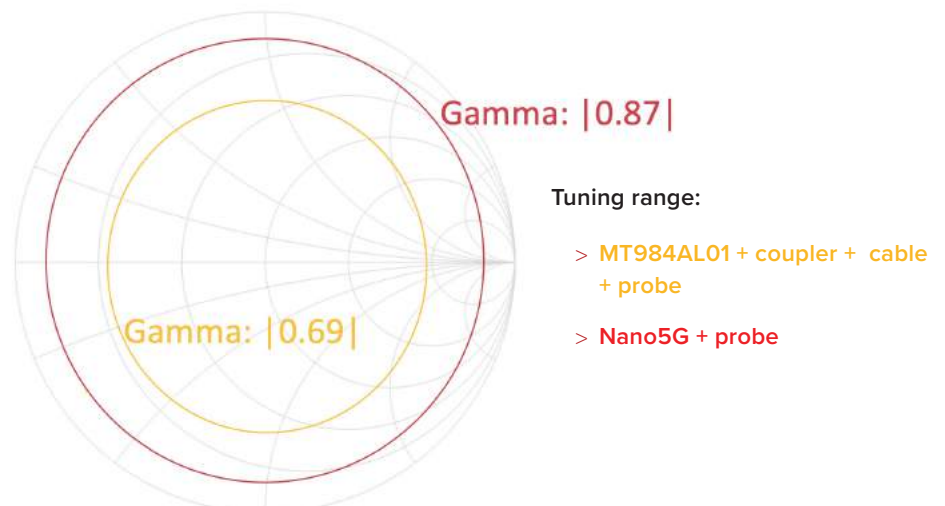

## Minimizing phase skew at the DUT reference plane

The phase shift, or phase delay, or phase skew of the impedance presented at the DUT reference plane is determined by the length of transmission line between the tuning element (probe inside of tuner) and the DUT. The larger the length, the greater the phase skew; the shorter the length, the smaller the phase skew. Minimizing the transmission line by removing integration cables or probe mounts helps reduce the phase skew of the impedance presented to the DUT. The Smith Chart below shows two scenarios: the first shows the phase skew of a tuner connected to a 6" integration cable and a wafer probe (yellow); the second shows the phase skew of the same tuner and probe, but no integration cable (red). Nano-series automated impedance tuners minimize the phase skew at the DUT reference plane!

● target

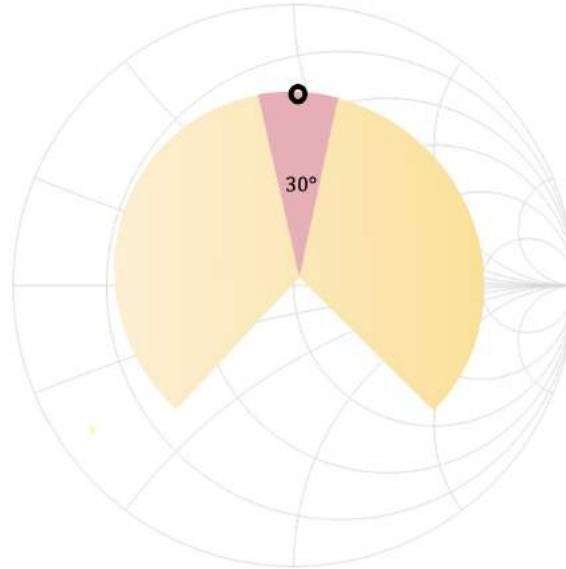

Phase skew:

Tuner Impedance phase variation over a 100 MHz input signal with left and right adjacent channels:

>  $\Delta\theta_{(MT984+cable+probe)} = 300^\circ$

>  $\Delta\theta_{(Nano5G+probe)} = 30^\circ$

---

## Integrated coupler

Modern vector-receiver load pull systems use a coupler between the tuner and DUT to directly measure the incident and reflected waves (a- and b-waves) at the DUT reference plane in real-time. Doing so eliminates the need for de-embedding tuner/fixture losses or relying on pre-characterized tuner positioning to determine the tuned impedance. These benefits usually come with a tuning range reduction as the coupler adds insertion loss between the tuner and DUT. Nano-series automated impedance tuners are offered with an optional nearly-lossless integrated coupler that empowers vector-receiver load pull while maintaining the highest tuning range at the DUT reference plane.

# Nano-Series LXI™-Compliant Automated Tuner

## Available Models

Model	Frequency Range (GHZ)		Integrated coupler <sup>1</sup>	Matching Range		Power capability (W)	Vector repeatability (dB)	IL (dB)	Connector type	Weight (lbs)	Length (in)
	Tuner	Impedance control		Minimum	Typical						
NT-18G-50G-1C	DC - 65	18-50	no	10:1	40:1 @ 28, 39 GHz	10 CW, 100W PEP	-40	0.5	1.85mm	0.7	2.35"
NT-18G-50G-1C-C			yes								3.35"

<sup>1</sup> 40 dB coupling factor

## Accessories Provided

Each tuner is provided with:

- > Power Supply
- > USB cable and TCPIP cable
- > USB to ethernet adapter
- > NT-C Tuner controller
- > Operating Manual

## Recommended Accessories

### 8799A1 Torque Wrench

Recommended for tightening all 3.5mm, 2.92mm, 2.4mm & 1.85mm precision connectors to the proper in. lbs without over-torquing the connection.



8799A1

### A048A 2.4mm/1.85mm Digital Connector Gage Kit

Recommended for checking the critical interface dimensions of precision 2.4mm & 1.85mm connectors. Digital indicator style.



A048A



## Dimensions

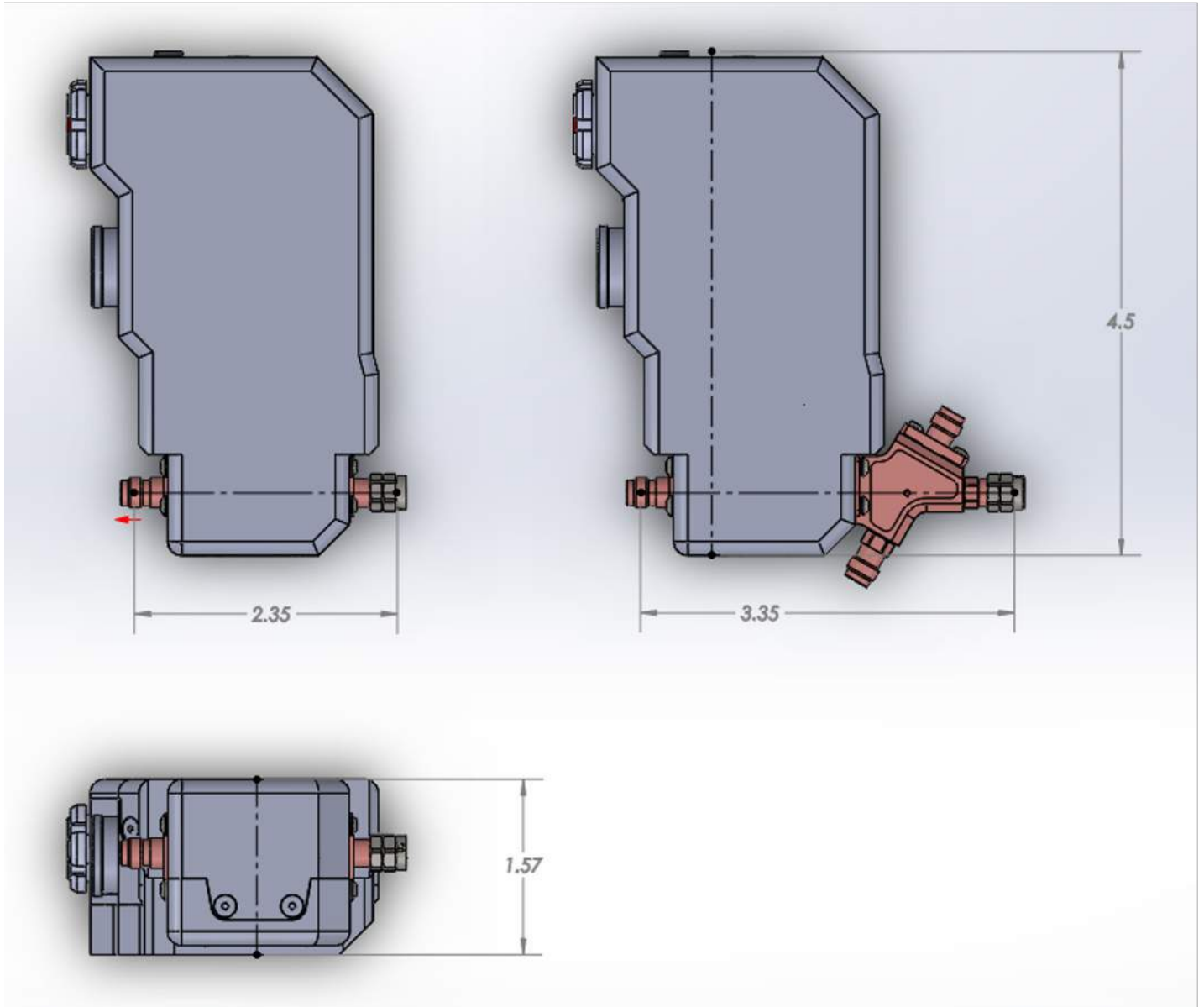

# Exemplary Performance Data for Model NT-18G-50G-1C 1.85mm Automated Tuners

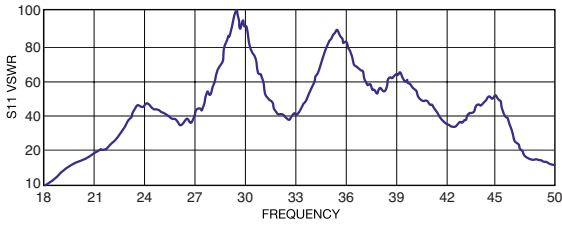

*VSWR versus Frequency for NT-18G-50G-1C automated tuners.*

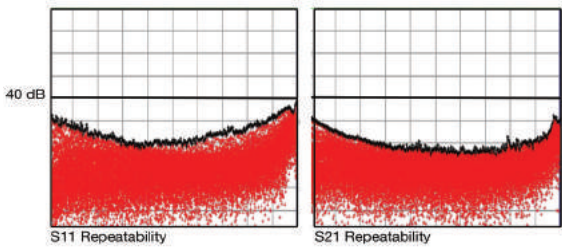

*Repeatability for NT-18G-50G-1C automated tuners.*



# NT-18G-50G-1C

*Products covered by one or more of the following patents  
9,209,786 / 8,823,392 / 7,589,601 B2*

## Specifications

Frequency Range -- 18.0 to 50.0 GHz  
 VSWR Matching Range  
 Minimum -- 10:1  
 Typical -- 40:1 @ 28 GHz, 39 GHz  
 Step Size (Probes) -- 3.94 microinches  
 Step Size (Carriage) -- 3.94 microinches  
 Connectors -- Precision 1.85mm, M/F <sup>1</sup>

Power Capability -- 10W CW, 100W PEP <sup>2</sup>  
 Vector Repeatability (Min.) -- -40 dB  
 Insertion Loss (probes fully retracted) -- 0.5 dB

<sup>1</sup> Precision 1.85mm per Maury data sheet 5W-089.

<sup>2</sup> Power rated at maximum VSWR.

# Exemplary Performance Data for Model NT-18G-50G-1C-C 1.85mm Automated Tuners

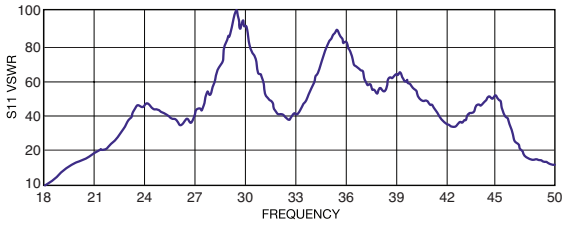

*VSWR versus Frequency for NT-18G-50G-1C-C automated tuners.*

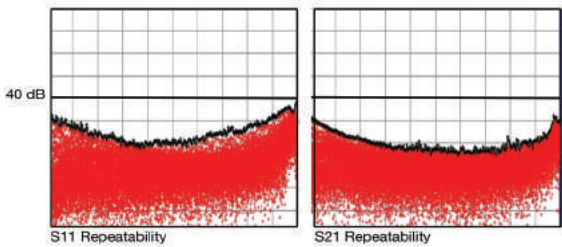

*Repeatability for NT-18G-50G-1C-C automated tuners.*

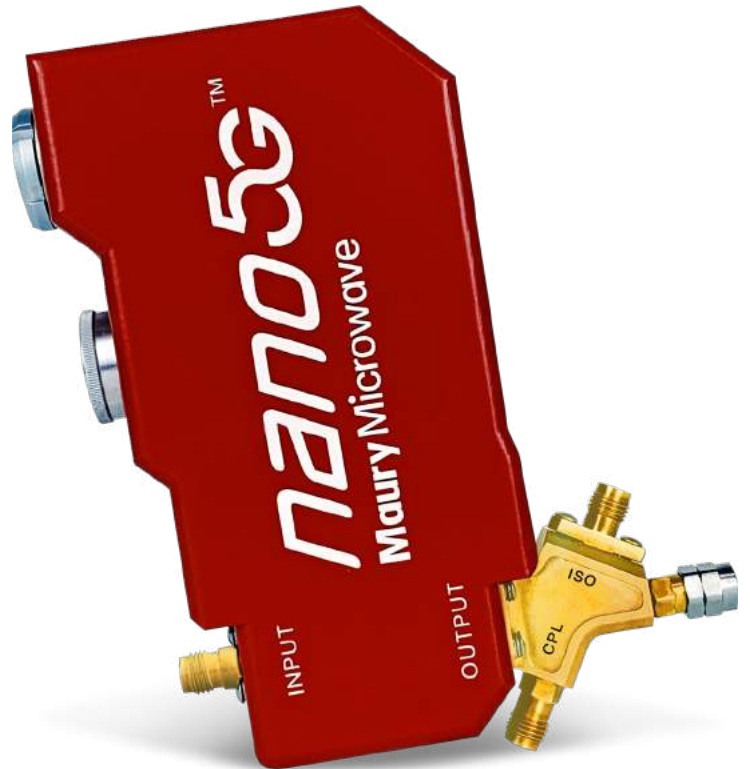

# NT-18G- 50G- 1C-C

*Products covered by one or more of the following patents  
9,209,786 / 8,823,392 / 7,589,601 B2*

## Specifications

Frequency Range -- 18.0 to 50.0 GHz  
 VSWR Matching Range  
 Minimum -- 10:1  
 Typical -- 40:1 @ 28 GHz, 39 GHz  
 Coupler -- 40 dB coupling  
 Step Size (Probes) -- 3.94 microinches  
 Step Size (Carriage) -- 3.94 microinches  
 Connectors -- Precision 1.85mm, M/F <sup>1</sup>

Power Capability -- 10W CW, 100W PEP <sup>2</sup>  
 Vector Repeatability (Min.) -- -40 dB  
 Insertion Loss (probes fully retracted) -- 0.5 dB

<sup>1</sup> Precision 1.85mm per Maury data sheet 5W-089.

<sup>2</sup> Power rated at maximum VSWR.

VISIT OUR WEB STORE  
TO LEARN MORE ABOUT  
OUR PRODUCTS

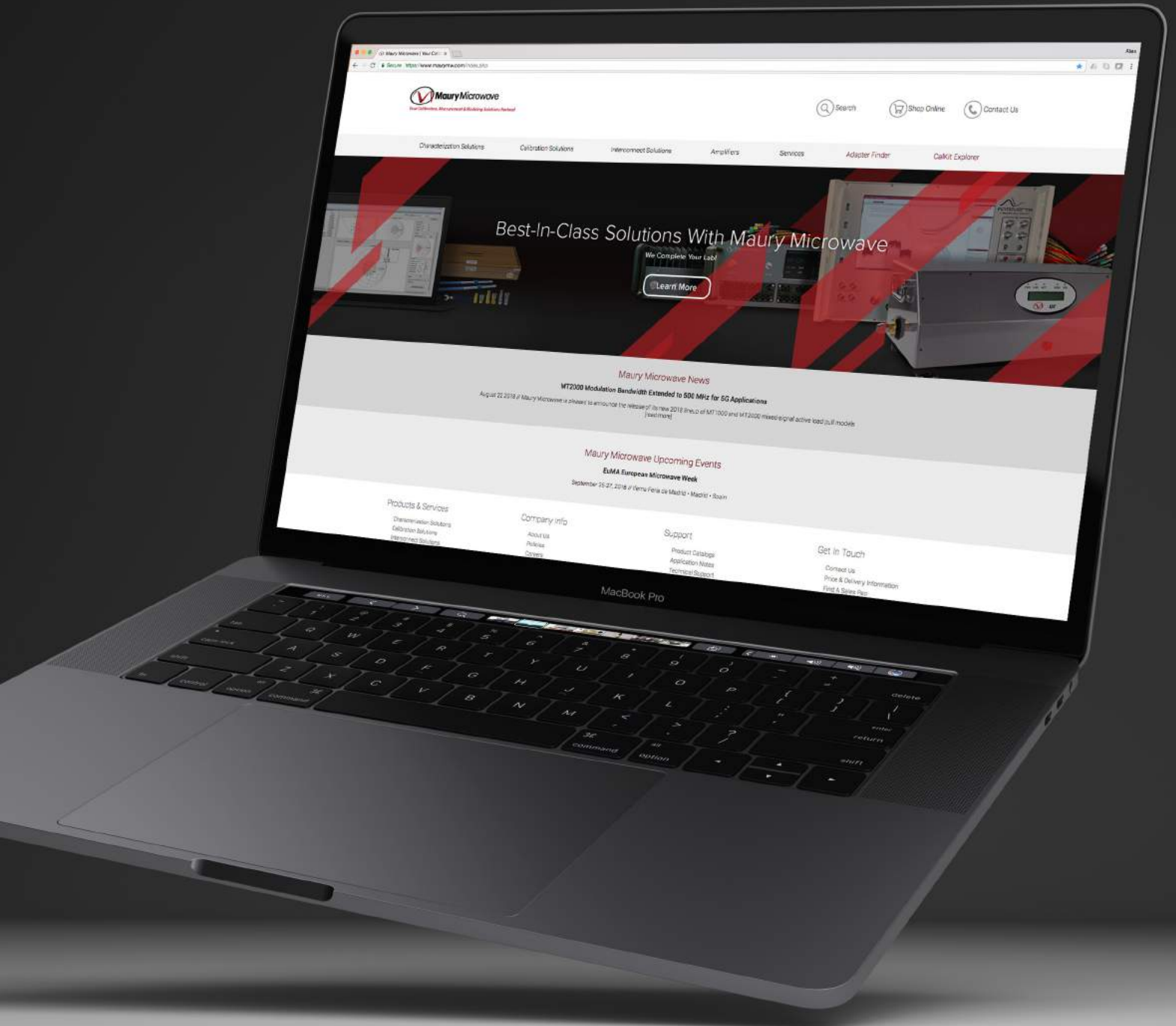

www.maurymw.com



**CONTACT US:**

W / [maurymw.com](http://maurymw.com)

E / [maury@maurymw.com](mailto:maury@maurymw.com)

P / +1-909-987-4715

F / +1-909-987-1112

2900 Inland Empire Blvd

Ontario, CA 91764

