

OPERATING INSTRUCTIONS AND SPECIFICATIONS

NI 9435

4-Channel, Universal Digital Input Module

Français Deutsch 日本語 한국어 简体中文

ni.com/manuals

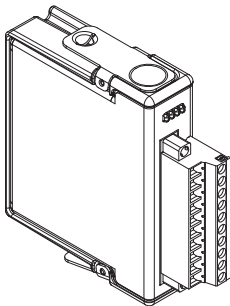

This document describes how to use the National Instruments 9435 and includes specifications and terminal assignments for the NI 9435. Visit `ni.com/info` and enter `rdsoftwareversion` to determine which software you need for the modules you are using. For information about installing, configuring, and programming the system, refer to the system documentation. Visit `ni.com/info` and enter `cseriesdoc` for information about C Series documentation.



Note The safety guidelines and specifications in this document are specific to the NI 9435. The other components in the system might not meet the same safety ratings and specifications. Refer to the documentation for each component in the system to determine the safety ratings and specifications for the entire system. Visit `ni.com/info` and enter `cseriesdoc` for information about C Series documentation.

Safety Guidelines

Operate the NI 9435 only as described in these operating instructions.



Hot Surface This icon denotes that the component may be hot. Touching this component may result in bodily injury.

Safety Guidelines for Hazardous Voltages

If hazardous voltages are connected to the module, take the following precautions. A hazardous voltage is a voltage greater than 42.4 V_{pk} or 60 VDC to earth ground.



Caution Ensure that hazardous voltage wiring is performed only by qualified personnel adhering to local electrical standards.



Caution Do *not* mix hazardous voltage circuits and human-accessible circuits on the same module.



Caution Make sure that devices and circuits connected to the module are properly insulated from human contact.



Caution When module terminals are hazardous voltage LIVE ($>42.4 V_{pk}/60 VDC$), you must ensure that devices and circuits connected to the module are properly insulated from human contact. You must use the NI 9932 connector backshell to ensure that the terminals are *not* accessible.

Figure 1 shows the NI 9932 connector backshell.

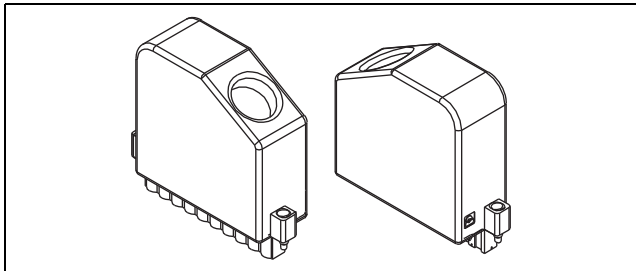

Figure 1. NI 9932 Connector Backshell

Safety Guidelines for Hazardous Locations

The NI 9435 is suitable for use in Class I, Division 2, Groups A, B, C, D, T4 hazardous locations and nonhazardous locations only. Follow these guidelines if you are installing the NI 9435 in a potentially explosive environment. Not following these guidelines may result in serious injury or death.



Caution Do *not* disconnect I/O-side wires or connectors unless power has been switched off or the area is known to be nonhazardous.



Caution Do *not* remove modules unless power has been switched off or the area is known to be nonhazardous.



Caution Substitution of components may impair suitability for Class I, Division 2.

Special Conditions for Marine Applications

Some modules are Lloyd's Register (LR) Type Approved for marine applications. To verify Lloyd's Register certification, visit ni.com/certification and search for the LR certificate, or look for the Lloyd's Register mark on the module.



Caution To meet radio frequency emission requirements for marine applications, use shielded cables and install the system in a metal enclosure. Suppression ferrites must be installed on power supply inputs near power entries to modules and controllers. Power supply and module cables must be separated on opposite sides of the enclosure and must enter and exit through opposing enclosure walls.

Connecting the NI 9435

The NI 9435 has a 10-terminal, detachable screw-terminal connector that provides connections for four digital input channels.

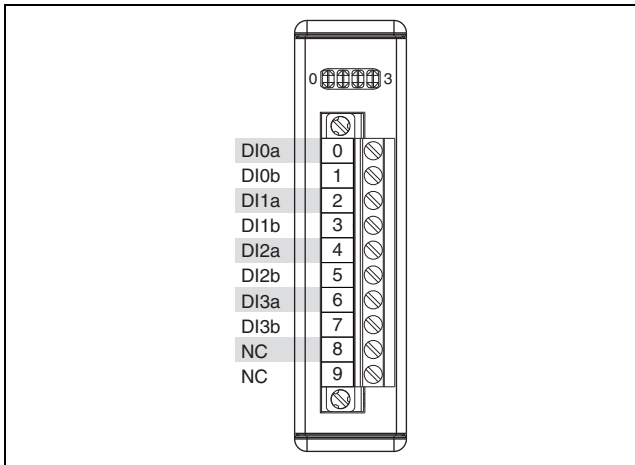

Figure 2. NI 9435 Terminal Assignments

Each channel has two terminals, DIa and DIb, to which you can connect voltage signals. The DIa and DIb terminals are interchangeable. The NI 9435 measures whether the difference between the DIa and DIb terminals is greater than or less than the digital logic levels and limits the current flow as needed. Refer to the *Specifications* section for more information about digital logic levels and the module-limited input current. Refer to Figure 3 for an illustration of the circuitry for one channel of the NI 9435.

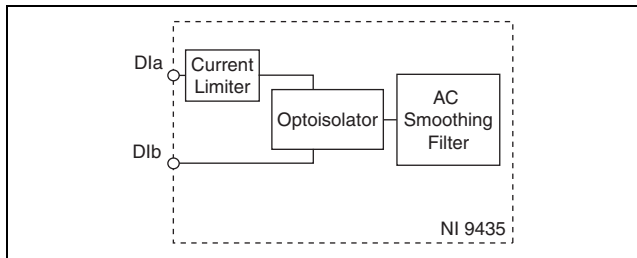

Figure 3. Input Circuitry for One Channel of the NI 9435



Note You must use 2-wire ferrules to create a secure connection when connecting more than one wire to a single terminal on the NI 9435.

The NI 9435 channel registers as ON when the external device drives a current or applies a voltage that is in the input ON range across the DI terminal. The channel registers as OFF when the device drives a current or applies a voltage that is in the input OFF range across the DI terminal. If no device is connected to DI, the channel registers as OFF. Refer to the *Specifications* section for more information about the ON and OFF states.

Each channel has an LED that turns on and off to indicate the state of that channel. When a channel LED is lit, the channel is on. When the LED is dark, the channel is off. The LEDs are disabled when the chassis is in sleep mode. Refer to the *Sleep Mode* section for more information about sleep mode.

Connecting Sinking-Output Devices to the NI 9435

You can connect sinking-output devices to the NI 9435.

A sinking-output device provides a path for current or voltage from the DIa or DIb terminal. An example of a sinking-output device is an open collector NPN. Connect the device to the DIa and DIb terminals on the NI 9435. Figure 4 shows a possible configuration.

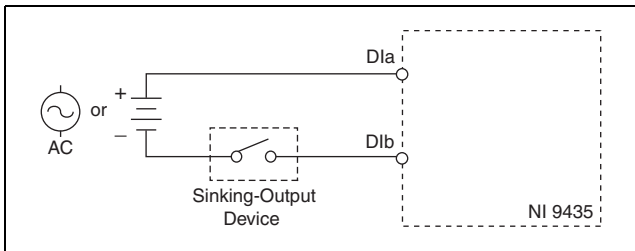

Figure 4. Connecting a Sinking-Output Device to the NI 9435

Connecting Sourcing-Output Devices to the NI 9435

You can connect sourcing-output devices to the NI 9435. A sourcing-output device drives current or applies voltage to the DIa or DIb terminal. An example of a sourcing-output device is an open collector PNP. Connect the device to the DIa and DIb terminals on the NI 9435. Figure 5 shows a possible configuration.

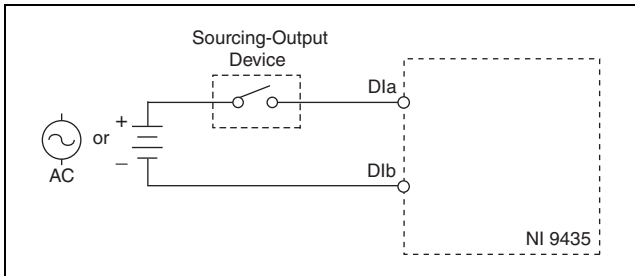

Figure 5. Connecting a Sourcing-Output Device to the NI 9435

Connecting Switches to the NI 9435

You can connect switches to the NI 9435. Connect either the DIa or the DIb terminal to the switch and the other DI terminal to the system ground. Figure 6 shows a possible configuration.

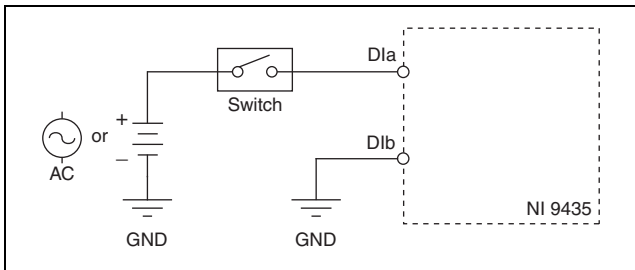

Figure 6. Connecting a Switch to the NI 9435

Sensing Power with the NI 9435

You can use the NI 9435 to sense when power is applied to a load. Connect the load to the DIa and DIb terminals on the NI 9435. Figure 7 shows a possible configuration.

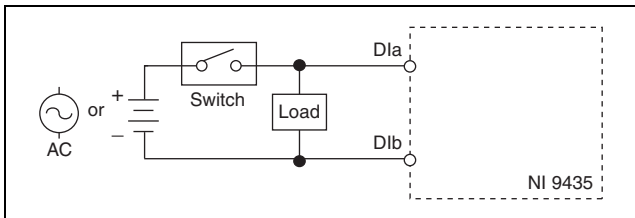

Figure 7. Connecting a Load to the NI 9435

Wiring for High-Vibration Applications

If an application is subject to high vibration, National Instruments recommends that you either use ferrules to terminate wires to the detachable screw-terminal connector or use the NI 9932 backshell kit to protect the connections. Refer to Figure 8 for an illustration of using ferrules. Refer to Figure 1 for an illustration of the NI 9932 connector backshell.

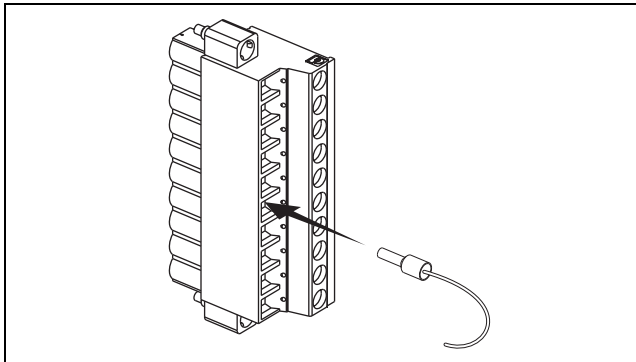

Figure 8. 10-Terminal Detachable Screw-Terminal Connector with Ferrule

Sleep Mode

This module supports a low-power sleep mode. Support for sleep mode at the system level depends on the chassis that the module is plugged into. Refer to the chassis manual for information about support for sleep mode. If the chassis supports sleep mode, refer to the software help for information about enabling sleep mode. Visit ni.com/info and enter `cseriesdoc` for information about C Series documentation.

Typically, when a system is in sleep mode, you cannot communicate with the modules. In sleep mode, the system consumes minimal power and may dissipate less heat than it does in normal mode. Refer to the *Specifications* section for more information about power consumption and thermal dissipation.

Specifications

The following specifications are typical for the range -40 to 70 °C unless otherwise noted. All voltages are relative to DIa–DIb unless otherwise noted.

Input Characteristics

Number of channels 4 digital input channels

Input type Sinking or sourcing

Digital logic levels

OFF state

Input voltage $\leq \pm 1$ VDC/VAC_{peak}

Input current $\leq \pm 200$ μ A DC/AC_{peak}

ON state

DC input voltage $\geq \pm 4$ VDC

DC input current ≥ 600 μ A DC

AC input voltage ≥ 10 V_{rms} at 50/60 Hz

AC input voltage ≥ 3 V_{rms} at 1 kHz

I/O protection

Input voltage (DIa–DIb)..... 250 VAC, ± 250 VDC max

Input current ± 1.4 mA max,
internally limited

Input delay time¹ 2.8 ms max

MTBF 700,726 hours at 25 °C;
Bellcore Issue 2, Method 1,
Case 3, Limited Part Stress
Method



Note Contact NI for Bellcore MTBF specifications at other temperatures or for MIL-HDBK-217F specifications.

¹ The input delay time is the minimum amount of time that the voltage across a channel must remain at the ON or OFF level to change the channel from ON to OFF or from OFF to ON.

Power Requirements

Power consumption from chassis

Active mode 105 mW max

Sleep mode 1.3 mW max

Thermal dissipation (at 70 °C)

Active mode 1.4 W max

Sleep mode 1.35 W max

Physical Characteristics

If you need to clean the module, wipe it with a dry towel.



Note For two-dimensional drawings and three-dimensional models of the C Series module and connectors, visit ni.com/dimensions and search by module number.

Screw-terminal wiring 12 to 24 AWG copper conductor wire with 10 mm (0.39 in.) of insulation stripped from the end

Torque for screw terminals 0.5 to 0.6 N · m (4.4 to 5.3 lb · in.)

Ferrules	0.25 mm ² to 2.5 mm ²
Weight.....	150 g (5.3 oz)

Safety

Safety Voltages

Connect only voltages that are within the following limits.

DIa-to-DIb	250 V _{rms} max, Measurement Category II
------------------	--

Isolation

Channel-to-channel None

Channel-to-earth ground

Continuous 250 V_{rms},
Measurement Category II

Withstand 2,300 V_{rms}, verified by a 5 s
dielectric withstand test

Measurement Category II is for measurements performed on circuits directly connected to the electrical distribution system. This category refers to local-level electrical distribution, such as that provided by a standard wall outlet, for example, 115 V for U.S. or 230 V for Europe.



Caution Do *not* connect the NI 9435 to signals or use for measurements within Measurement Categories III or IV.

Hazardous Locations

U.S. (UL) Class I, Division 2,
Groups A, B, C, D, T4



Note The NI 9435 is not approved for use in hazardous locations in Europe or Canada.

Safety Standards

This product meets the requirements of the following standards of safety for electrical equipment for measurement, control, and laboratory use:

- IEC 61010-1, EN 61010-1
- UL 61010-1, CSA 61010-1



Note For UL and other safety certifications, refer to the product label or the [Online Product Certification](#) section.

Electromagnetic Compatibility

This product meets the requirements of the following EMC standards for electrical equipment for measurement, control, and laboratory use:

- EN 61326 (IEC 61326): Class A emissions; Industrial immunity
- EN 55011 (CISPR 11): Group 1, Class A emissions
- AS/NZS CISPR 11: Group 1, Class A emissions
- FCC 47 CFR Part 15B: Class A emissions
- ICES-001: Class A emissions



Note For the standards applied to assess the EMC of this product, refer to the [Online Product Certification](#) section.



Note For EMC compliance, operate this device with double-shielded cables.

CE Compliance

This product meets the essential requirements of applicable European Directives as follows:

- 2006/95/EC; Low-Voltage Directive (safety)
- 2004/108/EC; Electromagnetic Compatibility Directive (EMC)

Online Product Certification

Refer to the product Declaration of Conformity (DoC) for additional regulatory compliance information. To obtain product certifications and the DoC for this product, visit ni.com/certification, search by module number or product line, and click the appropriate link in the Certification column.

Shock and Vibration

To meet these specifications, you must panel mount the system and either affix ferrules to the ends of the terminal wires or use the NI 9932 backshell kit to protect the connections.

Operating vibration

Random (IEC 60068-2-64)..... 5 g_{rms}, 10 to 500 Hz

Sinusoidal (IEC 60068-2-6) 5 g, 10 to 500 Hz

Operating shock

(IEC 60068-2-27)..... 30 g, 11 ms half sine,
50 g, 3 ms half sine,
18 shocks at 6 orientations

Environmental

National Instruments C Series modules are intended for indoor use only but may be used outdoors if installed in a suitable enclosure. Refer to the manual for the chassis you are using for more information about meeting these specifications.

Operating temperature

(IEC 60068-2-1, IEC 60068-2-2) -40 to 70 °C

Storage temperature

(IEC 60068-2-1, IEC 60068-2-2) -40 to 85 °C

Ingress protection.....	IP 40
Operating humidity (IEC 60068-2-56).....	10 to 90% RH, noncondensing
Storage humidity (IEC 60068-2-56).....	5 to 95% RH, noncondensing
Maximum altitude.....	2,000 m
Pollution Degree	2

Environmental Management

National Instruments is committed to designing and manufacturing products in an environmentally responsible manner. NI recognizes that eliminating certain hazardous substances from our products is beneficial to the environment and to NI customers.

For additional environmental information, refer to the *NI and the Environment* Web page at ni.com/environment. This page contains the environmental regulations and directives with which NI complies, as well as other environmental information not included in this document.

Waste Electrical and Electronic Equipment (WEEE)



EU Customers At the end of the life cycle, all products *must* be sent to a WEEE recycling center. For more information about WEEE recycling centers and National Instruments WEEE initiatives, visit ni.com/environment/weee.

电子信息产品污染控制管理办法（中国 RoHS）



中国客户 National Instruments 符合中国电子信息产品中限制使用某些有害物质指令 (RoHS)。关于 National Instruments 中国 RoHS 合规性信息，请登录 ni.com/environment/rohs_china。(For information about China RoHS compliance, go to ni.com/environment/rohs_china.)

Where to Go for Support

The National Instruments Web site is your complete resource for technical support. At ni.com/support you have access to everything from troubleshooting and application development self-help resources to email and phone assistance from NI Application Engineers.

National Instruments corporate headquarters is located at 11500 North Mopac Expressway, Austin, Texas, 78759-3504. National Instruments also has offices located around the world to help address your support needs. For telephone support in the United States, create your service request at ni.com/support and follow the calling instructions or dial 512 795 8248. For telephone support outside the United States, contact your local branch office:

Australia 1800 300 800, Austria 43 662 457990-0,
Belgium 32 (0) 2 757 0020, Brazil 55 11 3262 3599,
Canada 800 433 3488, China 86 21 5050 9800,
Czech Republic 420 224 235 774, Denmark 45 45 76 26 00,
Finland 358 (0) 9 725 72511, France 01 57 66 24 24,
Germany 49 89 7413130, India 91 80 41190000,
Israel 972 3 6393737, Italy 39 02 41309277, Japan 0120-527196,

Korea 82 02 3451 3400, Lebanon 961 (0) 1 33 28 28,
Malaysia 1800 887710, Mexico 01 800 010 0793,
Netherlands 31 (0) 348 433 466, New Zealand 0800 553 322,
Norway 47 (0) 66 90 76 60, Poland 48 22 328 90 10,
Portugal 351 210 311 210, Russia 7 495 783 6851,
Singapore 1800 226 5886, Slovenia 386 3 425 42 00,
South Africa 27 0 11 805 8197, Spain 34 91 640 0085,
Sweden 46 (0) 8 587 895 00, Switzerland 41 56 2005151,
Taiwan 886 02 2377 2222, Thailand 662 278 6777,
Turkey 90 212 279 3031, United Kingdom 44 (0) 1635 523545

National Instruments, NI, ni.com, and LabVIEW are trademarks of National Instruments Corporation. Refer to the *Terms of Use* section on ni.com/legal for more information about National Instruments trademarks. Other product and company names mentioned herein are trademarks or trade names of their respective companies. For patents covering National Instruments products/technology, refer to the appropriate location: **Help»Patents** in your software, the `patents.txt` file on your media, or the *National Instruments Patent Notice* at ni.com/patents.

© 2003–2009 National Instruments Corp. All rights reserved.