

Polarization Synthesizer/Analyzer – PolaFlex™

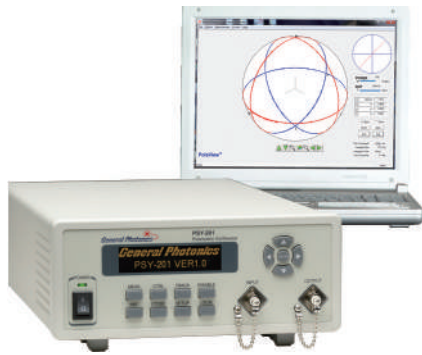

The PSY-201 is a deterministic polarization controller that can generate and maintain any state of polarization (SOP), regardless of the input SOP. It combines General Photonics' patented polarization controller, in-line polarimeter, and control algorithm into an instrument that functions as both a polarization state generator and a polarization analyzer. The generated SOP and the corresponding Poincaré Sphere representation can be displayed on a computer screen via USB interface. The output SOP can be specified by inputting Stokes parameters using the front panel keypad or by manually tuning the SOP to reach a specific point on the Poincaré sphere or to reach an optimum value of a polarization-dependent metric. Once a desired output SOP is found, the instrument can automatically maintain this SOP against input SOP fluctuations. Another attractive feature is that the user can generate any of 6 distinct SOPs (0° , 90° , $\pm 45^\circ$, RHC and LHC) for Mueller matrix calculations, or select any of the 6 states at the touch of a button. Furthermore, the instrument can generate several preprogrammed SOP traces

that emulate certain common polarization variations. The instrument can also function as a polarization scrambler, generating SOP scans with user-defined pattern and speed. Finally, with the internal polarization controller disabled, PolaFlex™ can function as an in-line polarimeter, displaying the instantaneous SOP and DOP of the input light beam. The PSY-201 replaces the popular PSY-101, with improved accuracy, speed, and functionalities. New features include long-term SOP monitoring, SOP markers for angle measurement, and a "SOP replay" function in sphere display mode, as well as extended triggering capability in oscilloscope mode. It puts all of the tools necessary for polarization management at your fingertips.

Specifications:

Operating Wavelength Range	1480 to 1620 nm or 1280 to 1340 nm
Sampling Rate (max.)	4.0M SOP samples/s
Analog Bandwidth ¹	1MHz
SOP Settling Time	1ms at stable input SOP
SOP Stability (Input Power > -25 dBm, DOP > 95%)	0.1° with stable input SOP 0.5° with input SOP variation < 2 π /s 2° with input SOP variation < 10 π /s
SOP Measurement/Generation Uncertainty	$\pm 0.25^\circ$ after user calibration, with input > -25 dBm
DOP Uncertainty	$\pm 2\%$ using built-in calibration, with input > -25 dBm $\pm 0.5\%$ after user calibration, with input > -25 dBm
Input Stokes Parameter Resolution	0.001
Optical Power Uncertainty	± 0.25 dB
Insertion Loss	1.6 dB max. at center wavelength
Return Loss	55 dB (APC connector), 45 dB (PC connector)
PDL	< 0.25 dB
PMD	< 0.1 ps
Operating Power Range	-35 dBm to +10 dBm
Optical Power Damage Threshold	300 mW
Operating Temperature	0 °C to 40 °C
Storage Temperature	-20 °C to 60 °C
Front Panel Display	Graphic OLED
Communication Interfaces	High Speed USB 2.0 (30 MB/s data rate) for PolaView software RS-232, Ethernet, GPIB
Analog Output	0 to 5 V max range, user configurable Monitor voltage for DOP, S1, S2, S3, power or dREF
Power Supply	100 – 240 VAC, 50 – 60 Hz
Software	PolaView™ (included)
Dimensions	2U, 19" half rack width 14" (L) x 8.5" (W) x 3.5" (H)

Note: Loss specifications are referenced without connectors. Unless otherwise noted, specifications listed in table apply for standard 1480-1620nm or 1280-1340nm operation at $23 \pm 5^\circ\text{C}$, at power levels > -25 dBm.

1. For input power > -10 dBm. At lower power levels, bandwidth may change due to automatic gain control.

Features:

- 4 MHz SOP sampling rate
- 1 MHz analog bandwidth
- 45 dB input power dynamic range
- Real-time Poincaré Sphere display
- High-speed SOP generation and tracking
- High speed analog output of SOP & DOP

Applications:

- Receiver polarization sensitivity analysis
- System SOP/DOP monitoring
- PER measurement
- Polarization generation and stabilization
- Sensor system characterization
- 100G system polarization characterization

Polarization Synthesizer/Analyzer – PolaFlex™

Application Example:

Coherent Receiver Polarization Sensitivity Test

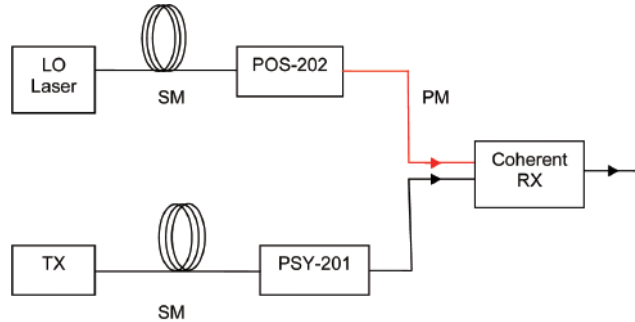

1. Use polarization stabilizer (POS-202) to lock the polarization of one receiver input (local oscillator input).
2. Use polarization synthesizer (PSY-201) to control the polarization of the other receiver input to find the SOP that maximizes the receiver power reading.
3. Lock the PSY-201 output at that SOP to eliminate polarization fluctuations in the SM fiber. Test receiver performance.
4. Use PSY-201 to find or switch to the orthogonal SOP (minimize receiver power reading).
5. Lock PSY-201 output at that SOP to eliminate polarization fluctuations. Test receiver performance.

Sample setup for a coherent receiver performance test using a polarization stabilizer (POS-202) and a polarization synthesizer (PSY-201).

Typical Performance Data:

Polarization stabilization

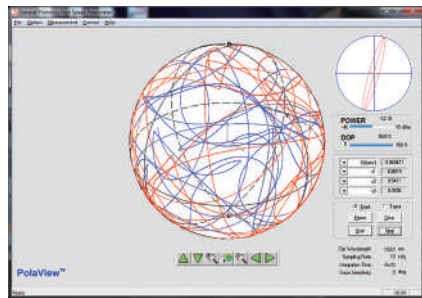

Figure 1. Input polarization pattern: triangle wave scramble at 1 Hz, taken over 20 sec

Special polarization state/trace generation

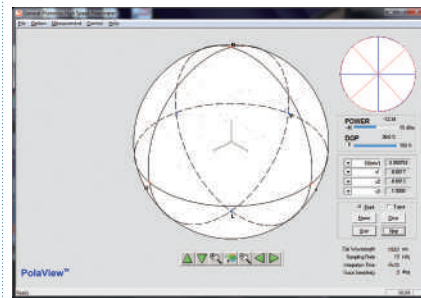

Figure 3. Poincaré sphere pole state generation

Scrambling

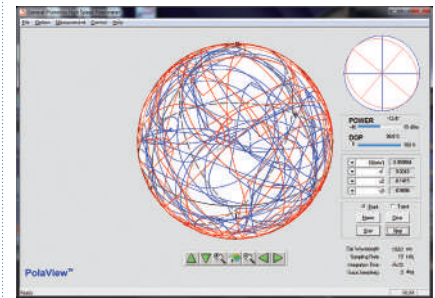

Figure 5. Triangle scrambling trace, 1 Hz after 1 minute

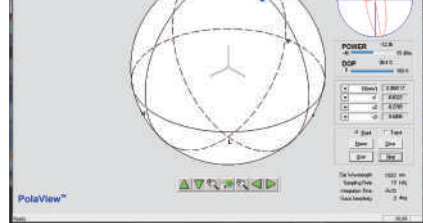

Figure 2. Output polarization stabilized by PSY-201 against the same polarization-scrambled input, taken over 20 sec

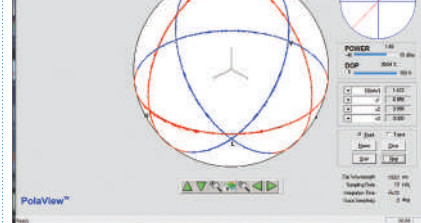

Figure 4. Trace Scans

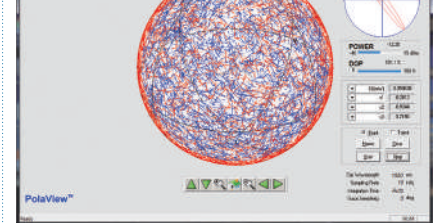
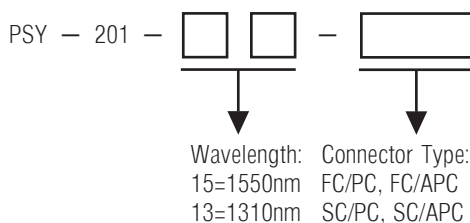

Figure 6. Discrete scrambling, 100 Hz after 1 minute

Ordering Information:



Accessories:

- NoTail™ Polarizer p. 90
- NoTail™ Isolator p. 91
- Rack Mount Kit p. 83