

Qx Series

ADVANCED RASTERIZERS FOR
HYBRID IP/SDI, 4K/UHD, HDR/WCG
GENERATION, ANALYSIS & MONITORING

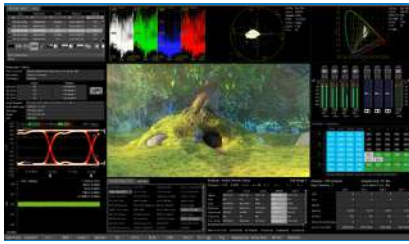

Qx Series - Technology to power change



From the moment you first power up a Qx, you'll appreciate the attention to detail in a platform designed to meet the increasing demands of monitoring and testing in SDI/IP hybrid environments. The Qx Series is equally at home in master control rooms, OB and link trucks, production studios, technical QC, product development, engineering compliance testing and operational system monitoring. Whether you are working in HD or UHD, SDR or HDR, SDI or IP, conventional or remote production, Qx rasterizers bring together all the user-configurability and advanced tools required for full operational flexibility when transitioning to your next generation workflows.

Available in two platforms, the Qx and the QxL, with a common look and feel, the Qx Series provides an accessible user interface and intuitive toolsets that help with rapid fault diagnosis and reduce the need for staff training. The comprehensive feature set supports HD/3G/6G/12G-SDI, 10G/25G IP interfaces, and HD/UHD, IP SMPTE 2022-6, SMPTE 2110-10/20/30/31/40 with ST 2022-7 and AMWA NMOS, easing system design and future proofing your investment.

Analyzer/Generator - Simultaneous Operation

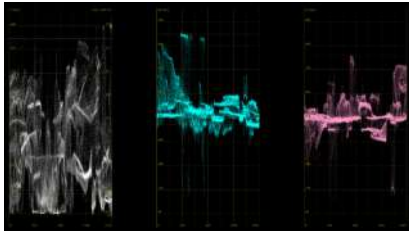
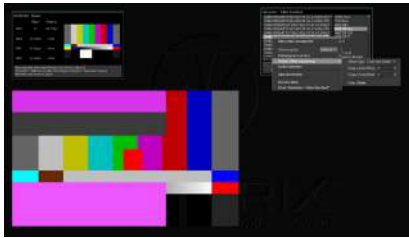

The Qx Series provides Generation and Analysis toolsets that can be used simultaneously either manually or under REST API control, enabling automated closed-loop testing of a wide range of standards and HD/3G/6G/12G-SDI formats for engineering regression testing and manufacturing. With a full suite of SDR Rec. BT 709/2020, plus native and mapped Wide Colour Gamut (WCG) HDR patterns in HLG, PQ, S-Log3 and SR-Live formats, you are equipped for flexible broadcast SDR and HDR operation.

Generator and Analyzer video format, colorimetry and transfer function can all be configured independently. You have the full flexibility to simultaneously send out a UHD Rec BT.2100 HDR pattern with up to 128 channels of audio, and analyze the down-converted, down-mapped HD SDR Rec 709 return at the same time.

Compliance - it's what test and measurement is all about...isn't it?

Developing products or commissioning the latest equipment is more than just implementation. Equipment has to be tested against the required standards for it to be considered fit for purpose.

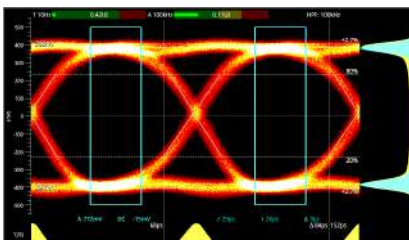

In the 12G-SDI world, noise floors are required to be much lower to ensure that accurate and meaningful measurements can be taken. Qx SDI generation and measurement technology has been specifically adapted for 12G applications. With its unique class leading SDI-STRESS toolset, sophisticated RTE™ (Real-Time Eye) multi-rate physical layer display, and automated SMPTE compliance measurements, the Qx offers a single product solution for SDI compliance verification.

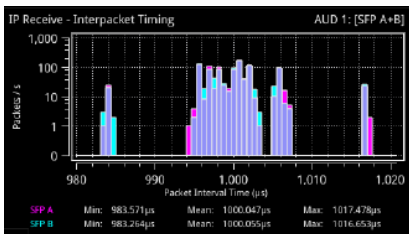

If you are working in SMPTE ST 2110, with ST 2059 Precision Time Protocol (PTP), the IP-MEAS test suite provides a comprehensive set of tools for compliance verification and commissioning of your IP systems and equipment. Hardware-based timestamping locked to PTP ensures accurate realtime deterministic timing measurements of media flows and ST 2110-21 buffer models.

Applications



Outside Broadcast

NEP UK selected Qx rasterizers for two of its new OB trucks, for use at major events and sporting fixtures. Hybrid SDI/IP capability was a key selling point for NEP enabling them to accommodate clients whether they are using conventional SDI or have made the move to IP. The ease of use of the Qx was also a major factor, making it quick and simple for both NEP engineering staff and freelancers to learn and use.

Engineering and Technical Director, NEP UK, said, “We’ve been very happy with the reliability of PHABRIX test and measurement equipment in the past, so it was an obvious fit to look at the Qx for these new IP-capable vehicles.”



Sports and Live Events

PHABRIX recently concluded nine months of successful HDR technology trials with BT Sport in the run-up to the launch of BT Sport Ultimate. The Qx is now deployed to monitor and analyze SDR and HDR Wide Color Gamut (WCG) material on the live system. PHABRIX supported BT Sport, providing its Qx rasterizers and technical expertise, as they developed and refined their live production workflow for the launch of their new HDR, UHD and Dolby Atmos® supported proposition. On the bench PHABRIX collaborated with BT Sport to analyze and provide suggested settings for SDR to HDR converters and ‘tone mappers’ used in the trucks and throughout the network.



Manufacturing & Compliance Testing

Mellanox Rivermax® development and regression testing teams have been using the Qx to provide simultaneous analysis of the SMPTE ST 2110 Video, Audio and ANC DATA flows from their Rivermax® video streaming library for media and entertainment, running on Mellanox ConnectX-5 and newer, Network Interface Cards,” said Nir Nitzani, senior director SW development at Mellanox Technologies.

“The ability to install the Qx in the machine room and remotely access and control the real-time measurements from several sites has been an ideal fit with our engineering development workflow.”

Platforms to suit every workflow

The Qx Series is available in two platforms, the Qx and QxL, both with a common look and feel, providing an accessible user interface and intuitive toolsets for full operational flexibility and easy migration from an SDI to an IP centric operation.

The flexible architecture of both the Qx and QxL offers in-field license upgrades for SDI-UHD/4K, HDR, IP, AV test signal generation as well as engineering grade data view and ANC packet inspection tools. A factory fitted hardware option provides RTE™ realtime SDI eye and jitter analysis with the further option of a highly advanced SDI-STRESS toolset.

PHABRIX Qx - 10GbE/12G-SDI

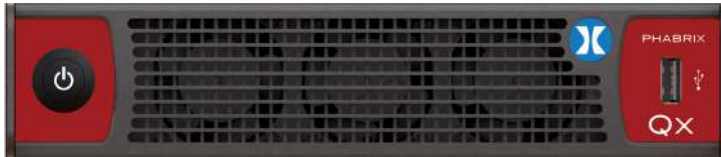

If your focus is on a classical SDI based HD facility and you would like to future-proof your operation for realtime IP, then the Qx will address your needs. With HD/3G SDI as standard, and including options for UHD/6G/12G-SDI, SMPTE ST 2110 and ST 2022-6 HD/3G payloads, you have the flexibility to migrate to hybrid SDI/IP or SDR/HDR operation with in-field license upgrades.

A factory fitted SDI Eye and Jitter hardware option and the unique SDI-STRESS toolset provide all the tools for SDI physical layer analysis and compliance testing.

The IP option supports payloads on native 10G SFP+ interfaces using generic IP SFPs, giving full access to be able to monitor and measure the IP traffic to SMPTE standards. In ST 2110 you can simultaneously analyze ST 2110-10/20/30/31/40 JT-NM tested* flows with Class C Audio (up to 80 channels at 125 μs packet time) all under ST 2022-7 Seamless IP Protection Switching (SIPS) and AMWA NMOS IS-04 discovery and IS-05 device connection management.

The IP-MEAS option provides a comprehensive set of tools for ST 2110 compliance verification and commissioning of your IP systems.

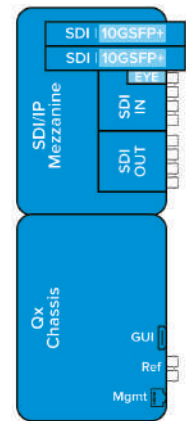

PHABRIX QxL - 25GbE/12G-SDI

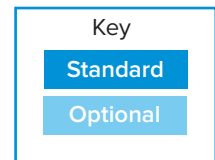
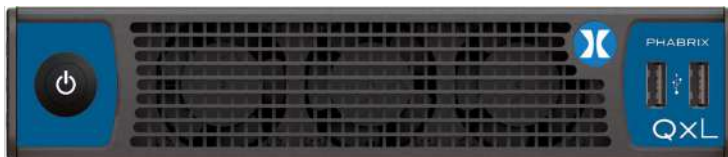

For real-time UHD IP workflows on 25G networks, the class leading QxL provides support for HD/3G 2110 and 2022-6 payloads on generic 10G/25G SFP28 interfaces as standard. The QxL is fully 10G/25G IP-enabled, with support for JT-NM TR 1001-1:2018, ST 2110-20 (video), 2110-30 (PCM) and 2110-31 (AES transport) audio, 2110-40 ANC media flows, all with 2022-7 Seamless IP Protection Switching (SIPS).

Independent PTP slaves on both media ports are provided for fully redundant media network operation with AMWA NMOS IS-04 discovery and IS-05 device connection management. The option of UHD payloads, HDR, and IP-MEAS in-field license upgrades means that you can tailor your system to your current needs while retaining full flexibility for the future.

SDI BNC and SFP media interfaces are available as a factory fitted option. The SDI Eye and Jitter hardware option and the unique SDI-STRESS toolset provide all the tools for SDI physical layer analysis and compliance testing.

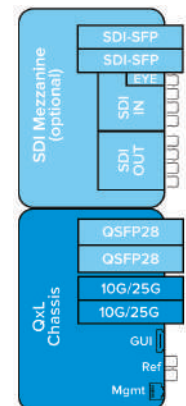

*JT-NM Tested - For more details on the JT-NM Tested Program (Spring 2020) and its test results, please see: http://jt-nm.org/jt-nm_tested/

Simplicity - an interface that puts you in control

The Qx's innovative app style interface is a radical change from traditional test and measurement systems. Intuitive mouse control with context driven drop down menus hides the complexity of modern SDI and IP systems providing an uncluttered view of critical information. Instruments can be resized, the system auto presenting more information as the screen area permits.

The Qx Series offers a fully flexible user-defined instrument layout, displaying up to 16 instruments on a single 1920x1080 display. Individual instruments can switch between 1/16th, 1/4 or full screen. With an output frame rate of 50, 50.94 or 60Hz to match the video format, the GUI has adjustable brightness for office or controlled lighting environments.

Instrument Tabs

- Tabs are featured along the top of the window to provide quick access to different functional groups within a single instrument

Instrument Tooltips

- The Qx UI employs a context driven tooltip providing additional information about parameters hovered over

Instrument Navigation

- Each instrument includes a pop-up submenu, which gives you access to the configuration parameters of that instrument

Instrument Launch Menu

- The intuitive instrument launch menu provides access to the instruments and other system menus available on the unit
- Each Instrument available in the menu is listed alongside a designated icon

Screen Capture

- SFTP and Browser network access to event logs, screenshots, user presets

Error Highlighting

- Errors are displayed in red font

Numeric Slider & Scroll Bar

- Adjust numeric values by dragging or scrolling the slider button for coarse numeric control
- Simply mouse over the numeric field and scroll for fine control
- Connect to USB keyboard, click and enter specific alpha numeric values

Presets

- Multiple display layouts can be saved as presets
- This allows users to save bespoke layouts for different operational tasks
- Useful for rapidly changing between different screen layouts eg. Audio, HDR or IP focus

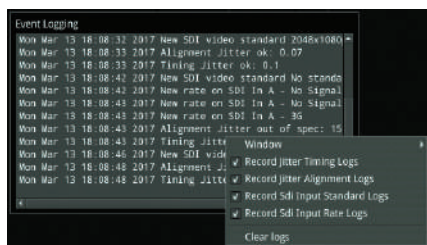

Event Logger

- SDI Input standard/status
- SDI physical layer timing and alignment jitter
- Rest API requests
- IP-Tx, IP-Rx, Flow and SFP records
- Reference Locking
- Audio input presence



VNC

- Interface employs VNC technology to deliver 16 simultaneous scalable instrument windows over a remote network



REST API

- The Qx can be controlled remotely over a network via a REST API
- Integrated control, monitoring and automated manufacturer testing

USB File Manager

- Copy presets, instrument logs, screenshots and user TIFF images via USB memory stick

I/O and Reference Configuration

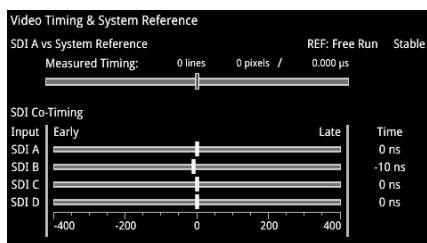

SDI Video Timing & System Reference

- Measurement of the timing of inputs against reference
- Indication of reference status and stability
- Indication of the relative co-timing of input SDI channels
- Graphical and numeric display
- Qx, QxL-01, QxL-01E Only

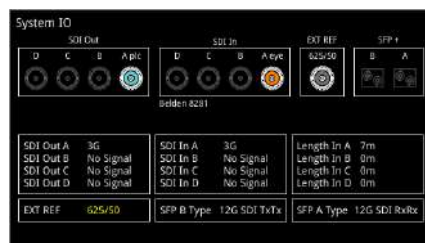

System IO

- Shows the status of signal inputs and outputs, external reference, cable length, and connector details
- SDI mode: Select BNC or SFP I/O, cable type, loop through and generator copy outputs
- IP mode: Active IP SFP receive inputs and transmit outputs are indicated

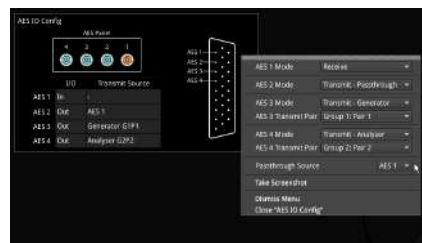

AES IO Config

- Four versatile bi-directional AES unbalanced interfaces
- Audio meter monitoring pair, generator audio output or AES input
- SDI Input to AES Output audio conversion for both PCM and Dolby encoded audio
- AES Input signals can be routed to other AES outputs providing up to three copy outputs

Analyser - Video Standard	
Input	Payload Identifiers (SMPT ST 352)
SDI A (3G)	Y-pos: 1920x1080p50 YCbCr:422:10 3G A HLG ColRec2020 (from ST 352 packet) C-pos: 1920x1080p50 YCbCr:422:10 3G A HLG ColRec2020 (from ST 352 packet)
SDI B (3G)	Y-pos: 1920x1080p50 YCbCr:422:10 3G A HLG ColRec2020 (from ST 352 packet) C-pos: 1920x1080p50 YCbCr:422:10 3G A HLG ColRec2020 (from ST 352 packet)
SDI C (3G)	Y-pos: 1920x1080p50 YCbCr:422:10 3G A HLG ColRec2020 (from ST 352 packet) C-pos: 1920x1080p50 YCbCr:422:10 3G A HLG ColRec2020 (from ST 352 packet)
SDI D (3G)	Y-pos: 1920x1080p50 YCbCr:422:10 3G A HLG ColRec2020 (from ST 352 packet) C-pos: 1920x1080p50 YCbCr:422:10 3G A HLG ColRec2020 (from ST 352 packet)

Analyser - Video Standard

- Display of detected SMPTE S352 Payload ID for each SDI Link and Subframe
- Manual over-ride of S352 ID
- Selection of SMPTE video format
- Indication of S352 errors
- Qx, QxL-01, QxL-01E Only

Analyser - CRC Analysis				
Analysis time: 2h 58m				
Last Failure Time: 11m 6s				
Input Failures: 257				
	Sub 1	Sub 2	Sub 3	Sub 4
C-CRC-Err	0	0	0	0
Y-CRC-Err	0	0	0	0
ANC-CS-Err	0	0	0	0
Rate (%)	0.002	0.000	0.000	0.000
Ok Time	9m 53s	11m 6s	11m 6s	11m 6s
Active Picture e Changes	0	0	0	0
Active Picture CRC	EC9D CACD	FEAF 7823	EC9D CACD	FEAF 7823

CRC Analysis

- Check for CRC errors on Y, C and ANC
- Reporting of the number of SDI input failures, the last failure time, total analysis time and error rates
- Detect active picture changes and view the active picture CRC to observe any changes in the expected active picture CRC value
- SDI switch line CRC masking control, for SMPTE RP168 compliance checking
- Qx, QxL-01, QxL-01E Only

Stats - SDI In A				
Data Rate: 11.880000 GHz	Clock Divisor: 1.000		12G Signal	
	Cable Length: <20m			
	Sub Image 1	Sub Image 2	Sub Image 3	Sub Image 4
Counters Stable	true	true	true	true
Active Samples Per Line	1920	1920	1920	1920
Active Lines Per Field	1080	1080	1080	1080
Total Samples Per Line	2640	2640	2640	2640
Total Lines Frame/Field1	1125	1125	1125	1125
Total Lines Field2	progressive	progressive	progressive	progressive
Payload ID Y-Pos	CE C9 80 01	CE C9 80 01	CE C9 80 01	CE C9 80 01
Payload ID C-Pos	CE C9 80 01	CE C9 80 01	CE C9 80 01	CE C9 80 01

Stats - SDI In

- Cable length indication
- Indication of data rate and clock divisor
- Reporting of active and total pixel and line counts
- Y and C payload ID
- Qx, QxL-01, QxL-01E Only

* Upcoming software release

Advanced Toolsets



Fast, automated 12G-SDI physical layer analysis [PHQX01E or PHQXL-01E]

The Qx Physical Layer Toolset is a factory fitted option for fast 12G/6G/3G/HD-SDI physical layer commissioning, testing and development. Its RTE™ (Real-Time Eye) Technology instantly highlights any SMPTE compliance issues and its realtime SDI jitter window provides simultaneous monitoring across five specified frequency bands, jitter histogram and video trigger options. Built-in automation control allows testing to be performed faster, more reliably and at lower cost. Included in the option are a full range of SDI eye measurements including amplitude, DC offset, transition times, overshoot and health indication with both amplitude and time histograms, as well as choice of color, heat-map overlays and infinite persistence display.

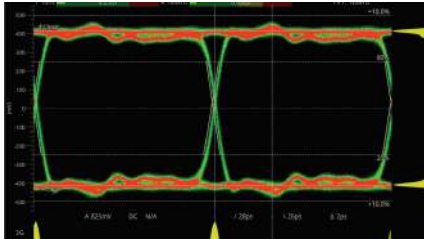

SDI EYE Analysis

- Real-Time Eye (RTE) for testing SMPTE compliance with indication of DC offset
- Automatic measurements of: DC level, amplitude, rise and fall time, rise/fall overshoot, visual rise time indication
- Amplitude and time histograms
- Single or multiple eyes with choice of color, heat-map overlay and infinite persistence
- Timing and Alignment jitter thermometers



SDI Jitter Analysis

- Realtime SMPTE jitter measurements down to 10Hz
- 10Hz, 100Hz, 1kHz, 10kHz, 100kHz filters
- H, 2H, F, V Trigger
- Infinite persistence modes
- +/- 0.25 to +/- 64 UI vertical scale adjustment
- Jitter amplitude histogram

Audio and Video Generation [PHQXO-GEN]

Simultaneously generate and analyze a comprehensive set of SDI and IP formats with the audio and video generation option. Moving test patterns with up to 32 channels of embedded audio per link or sub-field (up to 128 channels on 12G interfaces) is included. The Generator Toolset option provides not only the core full screen SDI Pathological stress patterns (Eq, PLL, Clk, CheckField), but uniquely also allows the user to define a percentage combination of the SDI pathological and conventional generator patterns up to full frame. Importing TIFF files for checking of HDR/WCG graphics or display and evaluation with user-created test images is also included.

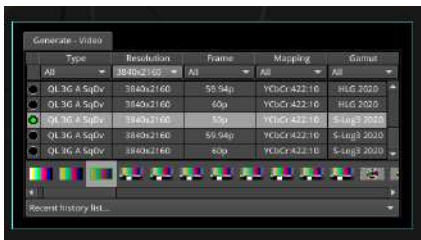

Video Generation

- 12G/6G/3G/1.5G 4K/UHD and 2K/HD SDI signal generation
- Support for Single, Dual and Quad link SDI formats. Square division and 2SI, Level A and B
- Moving test patterns
- 422, 444, 4224 and 4444, YCbCr and RGB formats, 10/12 bit
- Import and display of TIFF images

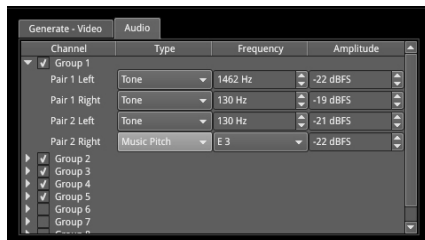

Audio Generation

- 32 channel audio generation, 128 channel embedder
- Choice of fixed tones or chromatic scale – to help with channel identification
- Choice of fixed or ramp levels – to help with channel identification
- Custom config of number of active audio groups and channels
- Master gain control



Pathological Generation

- Conventional SDI pathological stress patterns, Eq, PLL and CheckField
- New proposed SMPTE combined pathological stress pattern: Eq + PLL + Color Bars + Clock
- Define a percentage combination of SMPTE or SDI pathological and conventional patterns up to full frame

SDI-STRESS Testing [PHQXO-SDI-STRESS]

The advanced SDI-STRESS option is available for stress testing and R&D evaluations of SDI interfaces up to 12G. A comprehensive API is included for rapid automation testing. The option includes the ability under automation control to insert up to 128UI peak to peak SDI clock jitter from 10Hz to 10MHz, mute any of the SDI outputs, and control the SDI scrambler, sync-bit insertion, pre-emphasis, rise time and driver amplitude. The SDI-STRESS Eye amplitude measurement provides both Shorth Mean or Mode, with a histogram overlay and a user-defined window for the exploration of eye amplitude. Pseudo-Random Binary Sequence (PRBS) generation and analysis of PRBS-7, 9, 15, 23, 31 allows for deterministic measurement of link Bit Error Rates (BER).

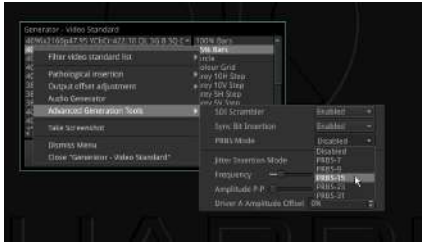

Adv. Generator Tools

- Generation of PRBS-7, 9, 15, 23, 31
- SDI scrambler and sync bit Insertion on/off
- Control of SDI driver amplitude +/-15%
- Control of jitter insertion frequency and amplitude
- Control of pre-emphasis, rise/fall time

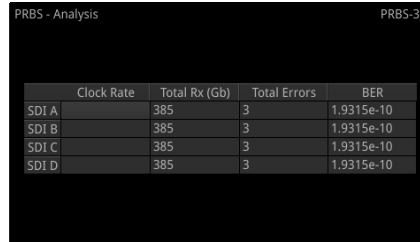

PRBS Analyzer

- Indication of PRBS cumulative received data and PRBS type
- Reported cumulative errors
- Calculated Bit Error Rate (BER)

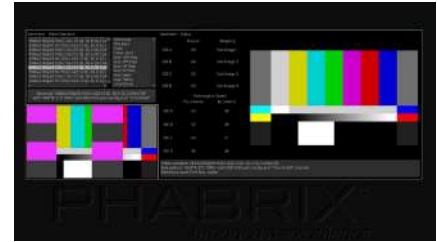

Pathological Detector

- Generator status indication of rate at which the video pattern generator is creating SDI pathological conditions
- Indication of PLL and EQ pathological rates/second
- Detection on each active SDI link
- Realtime GPI outputs of pathological detect for external equipment triggering

Advanced Eye Analysis

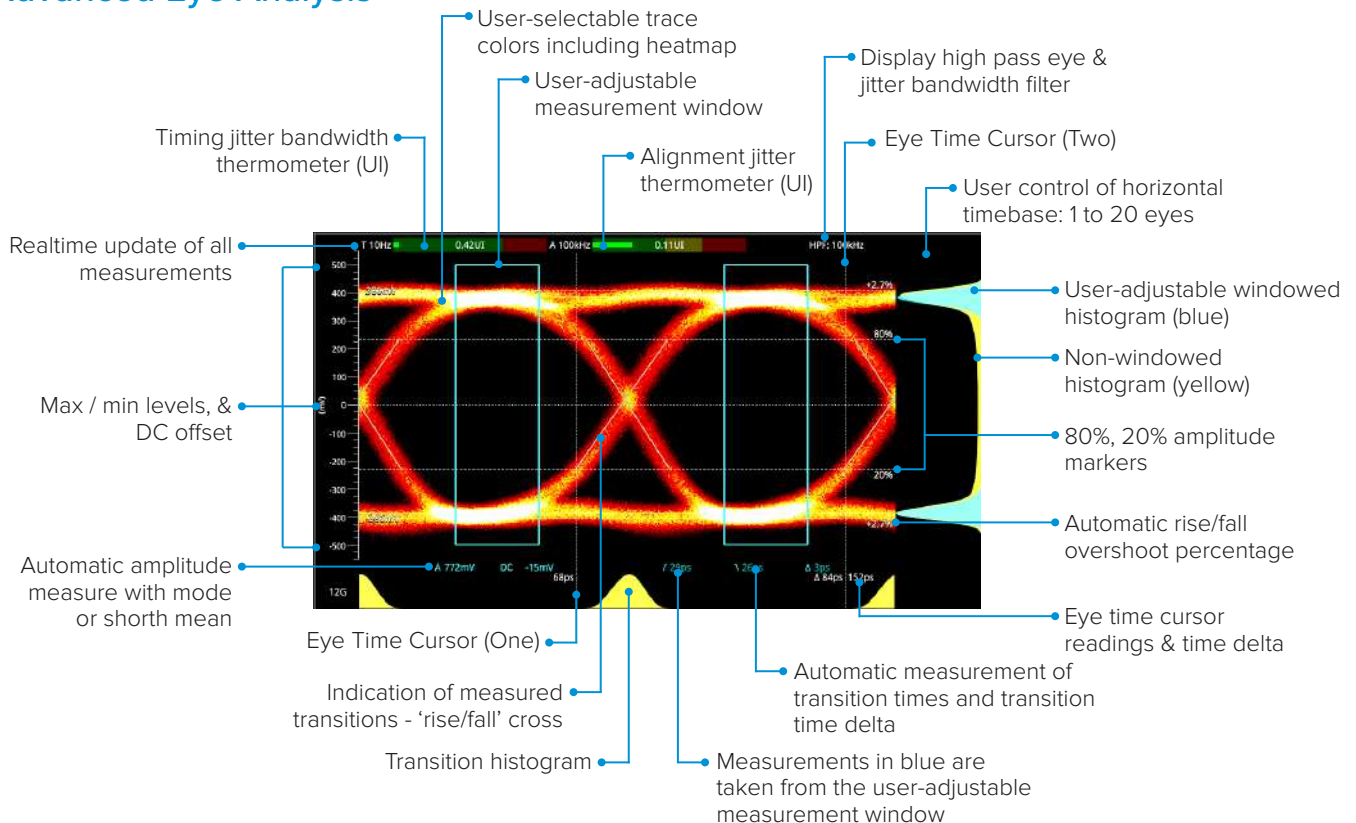

ST 2110 and ST 2022-6 Monitoring [PHQXO-IP-STND]

The Qx ST 2110 “JT-NM Tested”+ core IP feature set provides an operator all of the ST 2110 confidence status monitoring in an intuitive and accessible manner. The core toolset supports simultaneous decapsulation of 1 video, 2 audio and 1 ANC Data flow. Supported SMPTE protocols include ST 2059 (PTP) ST 2110-20 (Uncompressed Video), -30 (PCM Digital Audio), -31 (AES3 Transparent Transport) and -40 (ANC Data). ST 2022-7 seamless protection (SIPS) with AMWA NMOS IS-04, IS-05 and PTP system resource, is provided for all four flows over two media network interfaces using industry standard SFPs.

Audio handling conforms to ST 2110-30 Class C with support for 48kHz streams from 1 to 10 channels at packet times of 1ms and 1 to 80 channels at packet times of 125us.

Also provided is an indication of the timing relationship of each of the eight ST 2022-7 flows to PTP with status information, as well as a ST 2022-7 status tool that reports the health and relative timing skew of each ST 2022-7 pair all with hardware time stamping.

SMPTE 2110 & 2022-6

SFP IP Network		
	SFP A (Media Rx)	SFP B (Media Tx)
SFP Module	Present	Present
Carrier Signal	Present	Present
Interface	Up	Up
MAC Addr	00:1F:7F:01:4E:93	00:1F:7F:02:4E:93
IP Addressing Mode	Static	Static
IP Addr	192.168.1.20 / 24	192.168.1.30 / 24
Gateway	192.168.1.1	192.168.1.1
Total Tx pkts	624	17736650032
Total Rx pkts	9185408695	4796
SFP A:		
SFP B:		

SFP A - Info	
Temperature:	35.7 °C
Voltage:	3.22 V
Rx Power:	-4.18 dBm
Tx Power:	-2.97 dBm
Status:	Approved
Vendor:	Gigalight
Part No:	GPP-85192-SRC
Vendor OUI:	24-00-00
Revision:	1.0
Serial No:	M1901180211
Identifier:	SFP or SFP+
Ext Identifier:	GBIC/SFP function via two-wire only
Connector Type:	LC
Encoding:	64B/66B

IP Receive - Flow Select									
SFP	Seq	Protocol	Type	Dest IP	Src IP	SSRC	Bandwidth	Packets	Seq errors
A	192	2110-30	92	239.141.20.120000	192.168.16.141	100000	0	21 888 Mbps	465029004
A	192	2110-30	92	239.141.30.120000	192.168.16.141	100000	0	21 888 Mbps	465029005
A	192	2110-30	92	239.141.30.200000	192.168.16.141	100000	0	21 888 Mbps	465029006
A	192	2110-30	92	239.141.30.300000	192.168.16.141	100000	0	21 888 Mbps	465029007
A	192	2110-40	100	239.141.20.120000	192.168.16.141	100000	0	43 371 Mbps	1973026
B	192	2110-20	96	239.141.20.220000	192.168.16.141	100000	0	1 901 Gbps	470222099
B	192	2110-20	96	239.141.20.240000	192.168.16.141	100000	0	1 901 Gbps	470222100
B	192	2110-30	92	239.141.30.220000	192.168.16.141	100000	0	21 888 Mbps	464978435
B	192	2110-30	92	239.141.30.240000	192.168.16.141	100000	0	21 888 Mbps	464978436
B	192	2110-40	100	239.141.20.220000	192.168.16.141	100000	0	43 371 Mbps	1973026
B	192	2110-40	100	239.141.20.240000	192.168.16.141	100000	0	43 371 Mbps	1973026

SFP IP Network

- Reporting of presence of SFPs, SFP MAC and IP addresses (flow source IP address), and interface status
- Tx and Rx packet counters for indication of traffic activity
- User configuration of SFP IP Addresses, Masks and Gateway Addresses

SFP Information

- SFP status information for monitoring the physical network connection
- Indication of SFP vendor and laser characteristics
- RX and TX power for debug of fibre connectivity
- Optical link length indicator

IP Receive

- Reporting of the IP Flows available to the receiver and user selection of the required flows
- Indication of Qx locked status, Protocol, Src and Dst IP and Port Numbers, SSRC, Packet Counts, Sequence, payload and CRC errors
- Configuration of Multicast Destination IP addresses and subsequent Multicast Join requests

SMPTE 2110

PTP Info		
	Qx Status	Grand Master Info
IGMP Leave	Normal	Master ID: 08:00:11:FF:FE:22:B6:CE
Listening on domain	0	Domain: 0
Slave Mode	Multicast (M/M)	Priority 1: 128
Local PTP State	Slave	Priority 2: 128
Appl freq adjustmnt	-5428 ppb	Clock Class: 248
Appl freq adj delta	0 ppb	Clock Accuracy: > 10 s
Estimtd Phase Offset	0 ns	Variance: 15652
Last Sync message	One-step	Clock Source: Hand Set
SFP A:	PTP Locked	

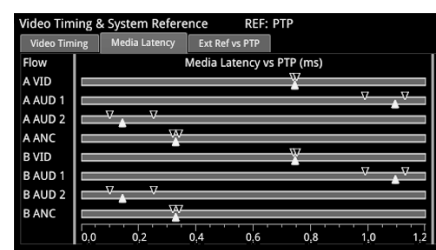
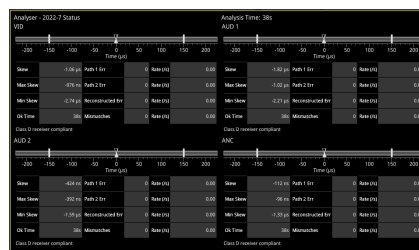

ST 2110 PTP Info - 2 port

- Control of PTP domain and communication mode (multicast, hybrid w/o negotiation)
- Indication of lock status
- Grandmaster information including master ID and time source
- Indication of estimated frequency and phase lock offsets
- Indication of one step or two step traffic
- 2 independent PTP slaves*

ST 2022-7 Status

- Indication of the health of ST 2022-7 seamless protection
- Warning of ST 2022-7 flow-pair mis-match
- Warnings of errors on flows and errors on reconstructed output and error rates/second
- Relative measure of Path Differential of flows on SFPB (Blue Network) relative to SFP A (Amber Network)
- Class A, B, C, D markers

IP Flow Latency

- Indication of media latency
- Relative timing of audio and ANC flows wrt video
- Indication of relationship of underlying media to PTP
- External analog reference timing wrt PTP



Advanced Toolsets

SMPTE 2110

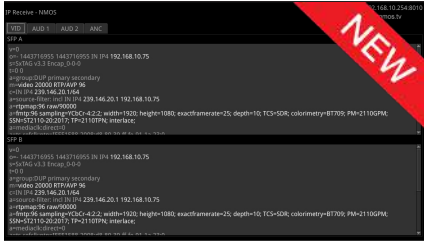

NMOS and SDP

- AMWA IS-04 V1.0, 1.1, 1.2, 1.3
- AMWA IS-05 V1.0.2, 1.1
- Unicast DNS-SD and mDNS
- Single or dual NMOS end points
- Display of SDP records for all flows with key parameters highlighted for improved visualization

LLDP Info		LLDP: Active	
	SFP A Neighbour	SFP B Neighbour	Mgmt Neighbour
Sys Name	switch-16628c	switch-16628c	phobos.phabrix.local
Sys Descr	MSN2010,Onyx,SWV3...	MSN2010,Onyx,SWV3...	Ubuntu 18.04.3 LTS Linux 4.15.0-88-generi...
Chassis ID	EC:0D:9A:FC:D0:00	EC:0D:9A:FC:D0:00	2C:4D:54:D4:07:A1
Port ID	Eth1/8	Eth1/11	00:1b:21:3a:45:d6
Port Descr			enp3s0
Mgmt IP	192.168.10.254	192.168.10.254	192.168.10.231
Primary VLAN	0	0	0

LLDP

- Identify port and device to which the Qx is connected
- Restrict information communicated over LLDP for IT security purposes
- Also available in ST 2022-6

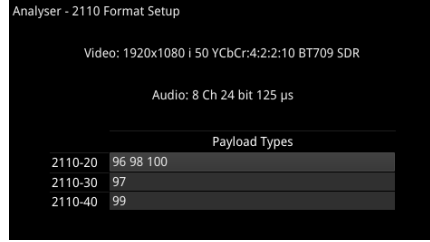

2110 Format Setup

- User-configurable allocation of ST 2110 packet IDs
- User-configurable video format parameters for ST 2110-20 flows
- User-configurable audio format parameters for ST 2110-30 flows includes packet time and channel count
- Automatic detection of audio format, channel count and packet time

IP Network Traffic Measurement [PHQXO-IP-MEAS]

An advanced engineering suite of tools for ST 2110 analysis and debug offers the provision of up to four simultaneous dual Packet Interval Timing measurement windows per input for easy visualization of network congestion and sender packet distribution with max, mean and min inter-packet arrival times. Also included is detailed data reporting of flow packet, clock rates and PTP timing relationship, as well as the measurements of the ST 2110-21 Network Compatibility model (C_{INST}) and Virtual Receiver Buffer Model (VRX). Advanced measurement of IP flow latency and RTP clock timing relationships for debug of Audio, Video and ANC alignment, source PTP and encapsulation are featured.

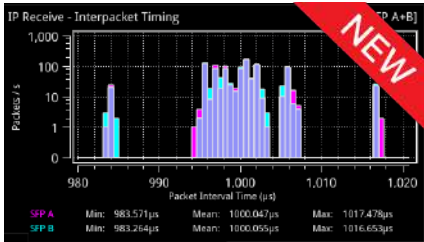

Inter-packet Timing

- Stream health reporting using histogram to visualize the distribution of inter-packet arrival times
- Simultaneous reporting of ST 2022-7 primary and secondary flow
- Packet counts (log or linear scales) mapped against arrival times (μ s)
- Easy diagnosis of congestion with max, mean and min inter-packet arrival times
- Also available in ST 2022-6

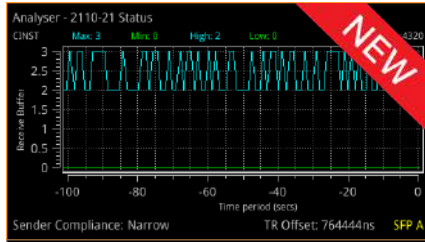

ST 2110-21

- ST 2110-21 measurement of Network Compatibility Model (C_{INST}) and Virtual Receiver Buffer Model (VRX)
- User control of VRX buffer read-schedule timing
- User control of C_{INST} buffer drain rate
- PCAP export of kernal traffic*

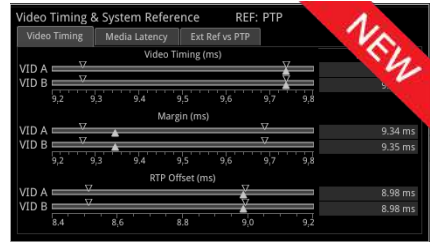

Advanced Media Timing

- First Packet Time (video timing)
- RTP offset
- Buffer margin
- Advanced, latency measurements
- Measured number of RTP packets and RTP clock rate per second
- Measured RTP clocks per packet per second

Packet Interval Profile Generator [PHQXO-IP-NGT] (Requires PHQXO-GEN)

This is a ST 2022-6 packet generation tool for evaluating the ability of a receiver to handle a ST 2022-6 flow with jitter. Simulate IP video network packet jitter under a variety of network conditions by providing the ability to adjust the transmission distribution profile. Also view the interval timing distribution of the packets being generated, the number of packets being generated each second, against the deviation of each packet interval from the expected interval time.

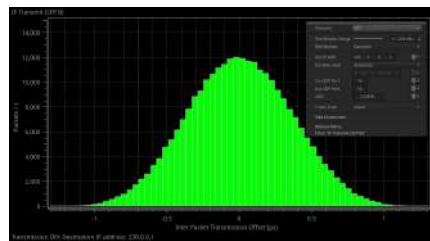

IP Transmit (ST 2022-6)

- Configuration of Transmission flow addresses, port numbers and SSRC
- Inter-packet jitter onto outgoing flow
- Gaussian or uniform distribution
- Flow control on/off

* Upcoming software release

Advanced Toolsets



High Dynamic Range (HDR) visualization & analysis toolset [PHQXO-HDR]

The Qx's comprehensive HDR toolset includes a signal generator, CIE chart, Luma false color highlighting or "heat map", waveform monitor and vectorscope. All the main live production SDR and HDR formats are supported: Standard Dynamic Range (SDR) BT.709, BT.2020 as well as HDR BT.2100 HLG, PQ and Sony S-Log3 and SR Live. The Waveform provides a Cd/m2 (nits) graticule along with BT.2048 diffuse white markers. The flexible user controlled HDR heatmap offers 7 simultaneous programmable color overlay bands with presets for HDR and SDR ranges, plus a user custom preset. The CIE 1931 xy display provides overlays for BT.709, BT.2020 and ST.2086 gamut (P3) to enhance the visualization and analysis of your HDR/WCG content.

HDR Generator

An extensive set of test patterns include BT.2111 HDR color bars for HLG, PQ and SR Live as well as a full set of SDR 709 patterns mapped via 'display light' to each of the four HDR formats for line checks, comparative monitor set-up and the evaluation of HDR to SDR converters.



False Color Highlighting

- Programmable 'Heat Map' to highlight luminance zones providing quick identification of shadows, skin or mid-tones or specular highlights
- 7 simultaneous programmable color overlay bands
- Presets for HDR and SDR ranges plus user custom

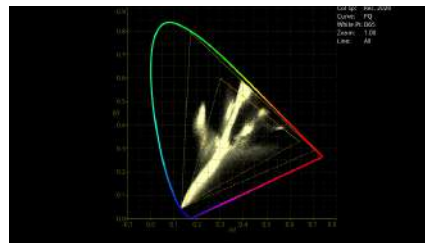

Analyzer - CIE Chart

- CIE 1931 xy display
- Single line mode linked to picture cursor
- Pan and zoom
- ITU-R BT. 709, BT. 2020 and ST 2086 gamut overlays
- Tooltip co-ordinate display
- Support for BT. 1886, BT. 2100 HLG and PQ, Sony S-Log3, SR Live

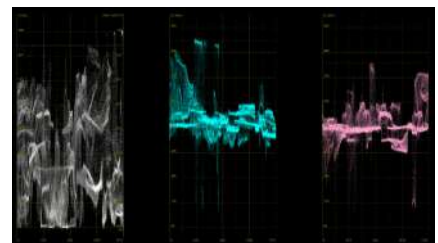

HDR Waveform

- Waveform HDR graticules with Nits (Cd/m²)
- BT. 2408 diffuse white markers
- Support for BT. 1886, BT. 2100 HLG and PQ, Sony S-Log3, SR Live

Data View Analyzer with ANC Inspector [PHQXO-DATA]

The sophisticated engineering grade Data View Analyzer and ANC Inspector toolset provides easy, accessible visualization of the data on an SDI interface and associated ANC packets. Deep SDI data inspection with full freedom to inspect Active Picture, VANC, HANC and API controls to read back Active Picture Data under automation control is included. Also featured is ANC packet decapsulation and error reporting for detailed analysis and debug of ANC payloads.



Analyzer - Data View

- Allows analysis of complex faults
- Detailed view of data words in the SDI stream with tooltip hint
- Navigate function for rapid access to a required line, pixel or TRS word
- Color coding to help identification
- Cursor linked to Picture and Waveform

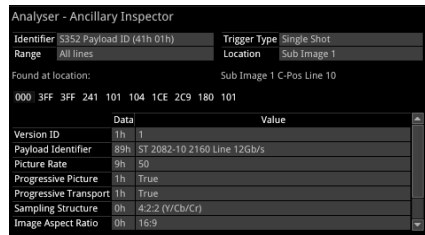

ANC Inspector

- Ancillary data packet analyzer
- Link from ANC Status window
- User-defined DID/SDID windowed search
- Trigger on error, single shot, continuous
- ANC packet capture with Hex view
- ANC packet decode view

Specifications



Formats supported (Generation, Analysis & Monitoring)		
IP SMPTE 2110/2022-7 over 10G IP	○	●
IP SMPTE 2022-6 over 10G IP	○	●
3G/1.5G-SDI HD Formats	●	Factory Option
12G/6G/3G/1.5G-SDI UHD Formats	○	Factory Option
SDI Eye and Jitter Physical Layer Analysis	Factory Option	Factory Option
UHD over 25G IP	-	○
Hardware and Software Options Supported		
Audio/Video Generator (SDI, ST 2022-6, ST 2110)	○	○
Eye and Jitter Toolset (Hardware Option)	○	○
UHD/4K Upgrade	SDI Option	○
SDI-STRESS Testing Toolset	○	○
Data View Analyzer with ANC Inspector	○	○
HDR/WCG Support	○	○
IP ST 2022-6 Decap, ST 2110-20/30/31/40 Decap with ST 2022-7 and PTP	○	●
IP Network Traffic Measurement Toolset (ST 2110)	○	○
IP Network Traffic Generation Toolset (ST 2022-6)	○	○
Video inputs / outputs		
4 x SDI inputs, HD/3G, 75 Ohm terminated BNC	●	Factory Option
2 x SFP+ MSA/NON-MSA cages (supports 12Gbps copper or fiber SDI interfaces)	●	Factory Option
4 x SDI outputs, HD/3G, 75 Ohm BNC	●	Factory Option
Support for 6G/12G SDI I/O	○	Factory Option
RTE™ Real-Time Eye input (12G/6G/3G/HD-SDI) x 1 (SDI input A) BNC	Factory Option	Factory Option
Ethernet IP inputs/outputs (accepts generic SFPs)		
2 x SFP+ 10G Cages (also supports MSA/NON-MSA 12Gbps copper or fiber SDI SFPs)	●	-
2 x SFP28 10/25G cages	-	●
2 x QSFP28 10/25/40/50/100G cages	-	○
Audio inputs/outputs		
4 x 75 Ohm AES selectable I/O (26 pin high density 'D' Type socket)	●	●
1 x Stereo analog audio output (26 pin high density 'D' Type socket)	●	●
8 channel 48kHz PCM audio on HDMI and SDI Instrument output	●	●
User interface		
HDMI instrument output, 1920 x 1080, 4:4:4 RGB, Type A	HDMI 1.4	HDMI 2.0b SDR/HDR*
SDI 3Gbit SDR/HDR instrument out, 1920 x 1080, 4:2:2 YCbCr	BNC	Micro BNC
ST 2110-20 SDR/HDR, ST 2110-30 instrument out, 1920 x 1080, 4:2:2 YCbCr	○	●
Reference		
2 x 75 Ohm BNC high impedance looping reference input, tri-level or B&B with cross lock	●	-
1 x 75 Ohm Micro-BNC terminating ref input, Tri/B&B with cross lock	-	●
Networking & control		
10/100/1000 BASE-T	●	●
8 x bi-directional GPI (26 pin high density 'D' Type socket)	●	●
Monitoring		
Internal Beeper	●	●
Form factor		
Size (Width x Height x Depth - excluding projections)	253 x 44 x 211 mm	253 x 44 x 211 mm
Weight	1.9 kg	1.9 kg
Electrical		
Power consumption	50W typical, 70W max	100W typical, 120W max
4 Pin XLR power connector	12V nominal (10V-18V)	12V nominal (10V-18V)
AC Power adapter	90-264VAC, 120W	90-264VAC, 120W
Warranty		
Warranty (1 year)	●	●
Extended Warranty Package (3 - 5 years)	○	○

● Standard
○ Optional
* Upcoming software release

Qx Rear panel

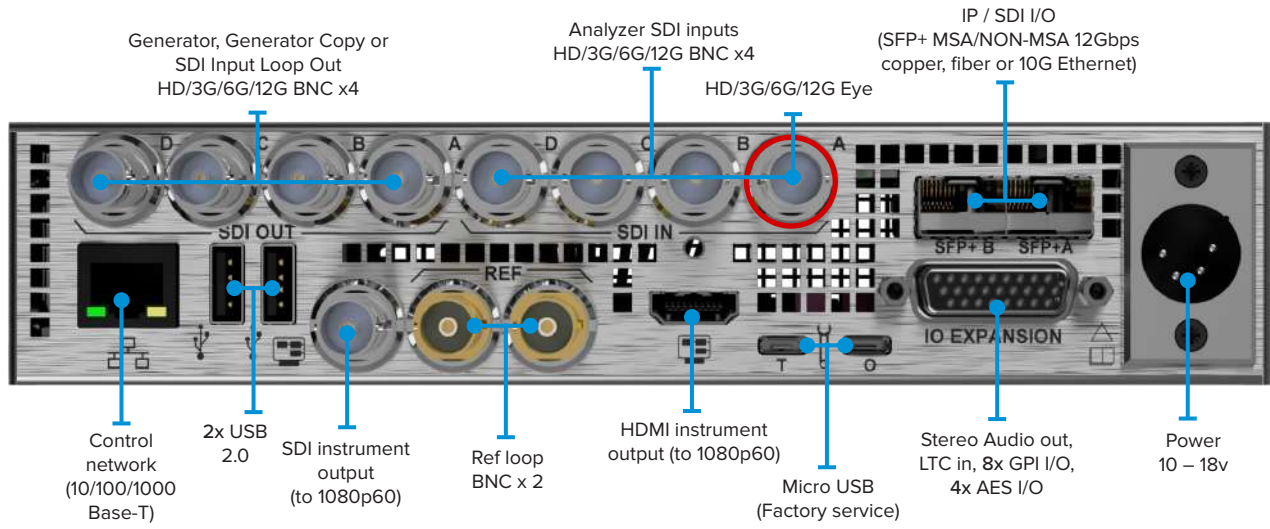

Qx/QxL Mezzanine Interface Card Block Diagram

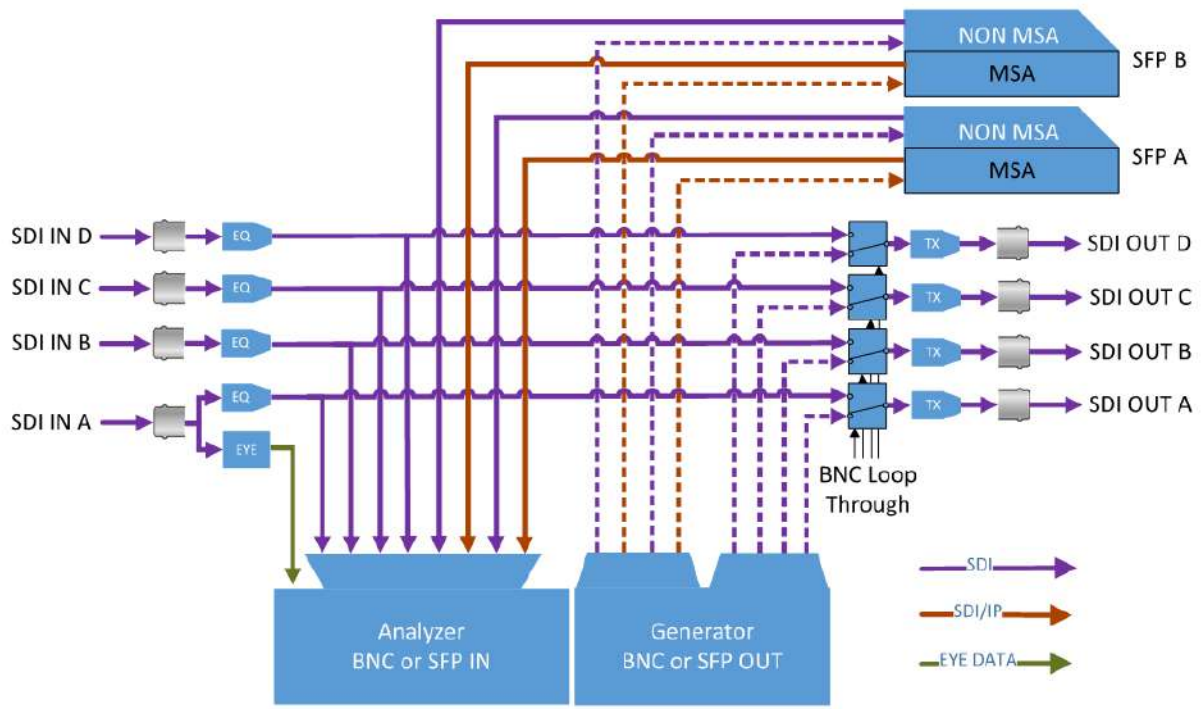

QxL Rear panel

QxL - IP Only

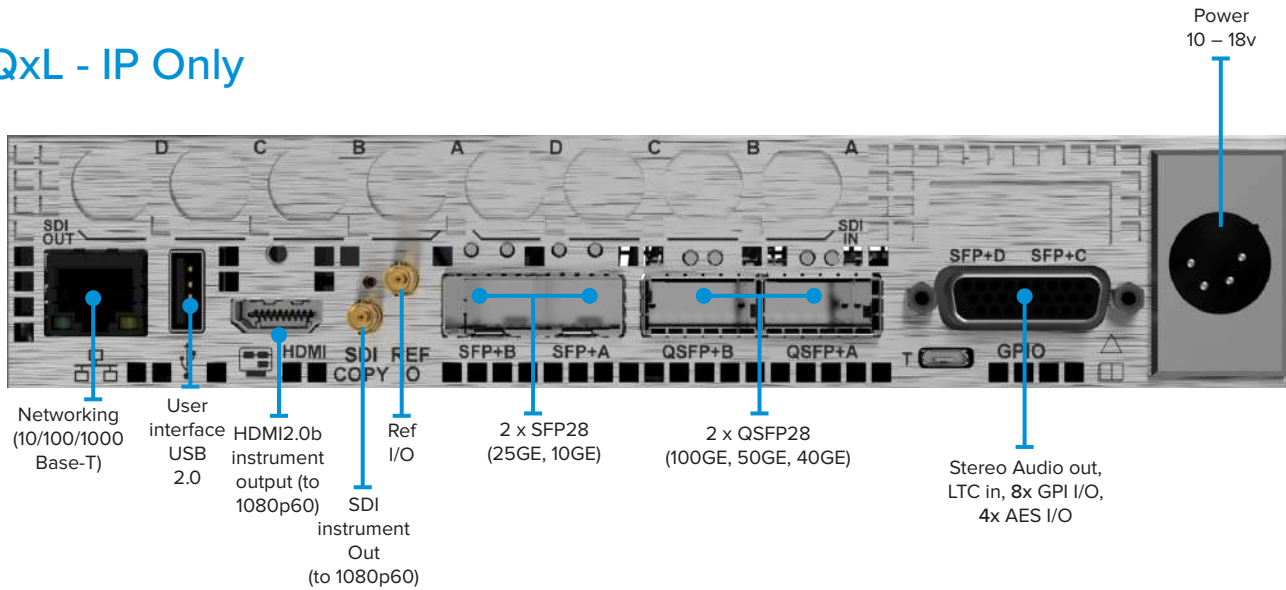

QxL with factory fitted SDI option

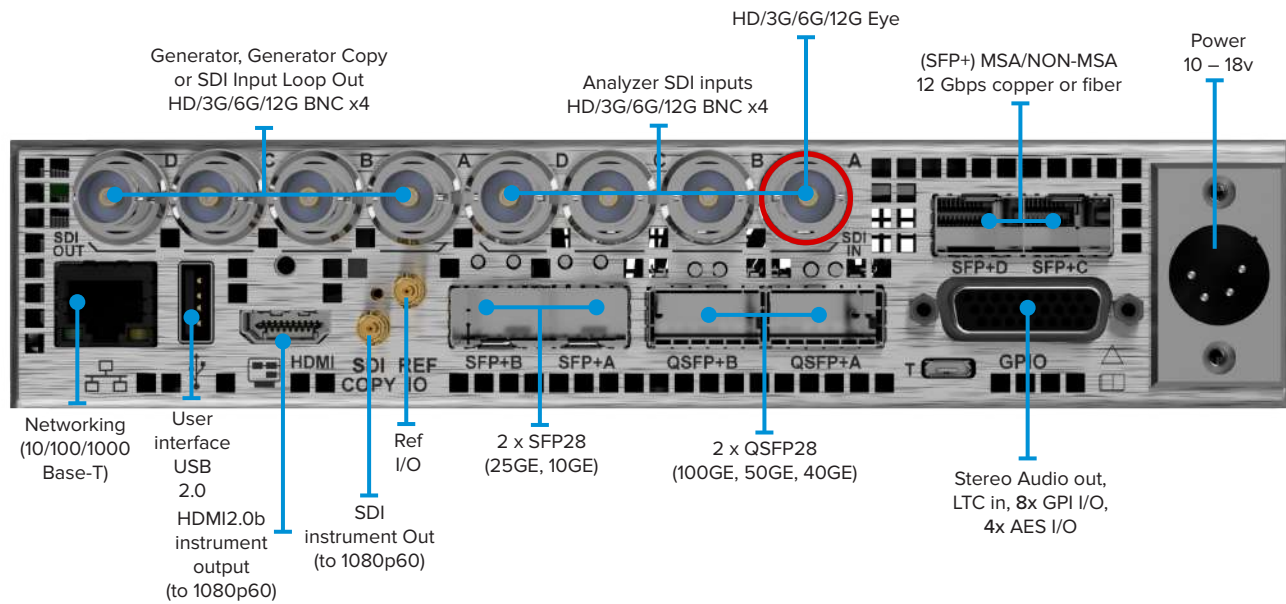

Supported 2K/HD Formats

The following SDI formats are standard on Qx and optional on QxL [PHQXL01-3G / PHQXL01E-3G]
 The following ST 2022-6 formats are optional on Qx [PHQXO-IP-STND] and standard on QxL.

SMPTE Stnds. Link (Content)	Interface	Resolution	Sampling Structure	Pixel Depth	Frame/Field Rate	HDR	SDI	2022-6
ST 292 (ST 296)	HD	1280 x 720	4:2:2 (YCbCr)	10	60p, 59.94p, 50p, 30p, 29.97p, 25p,	O	●	O
ST 292 (ST 274)	HD	1920 x 1080	4:2:2 (YCbCr)	10	60i, 59.94i, 50i	O	●	O
ST 292 (ST 274)	HD	1920 x 1080	4:2:2 (YCbCr)	10	30p, 29.97p, 25p, 24p, 23.98p	O	●	O
ST 292 (RP 211)	HD	1920 x 1080	4:2:2 (YCbCr)	10	30psF, 29.97psF, 25psF, 24psF, 23.98psF	O	●	O
ST 292 (ST 2048-2)	HD	2048 x 1080	4:2:2 (YCbCr)	10	30p, 29.97p, 25p, 24p, 23.98p, 30psF, 29.97psF, 25psF, 24psF, 23.98psF	O	●	O
ST 425-1 (ST 274)	3G Level A (I)	1920 x 1080	4:2:2 (YCbCr)	10	60p, 59.94p, 50p	O	●	O
ST 425-1 (ST 2048-2)	3G Level A (I)	2048 x 1080	4:2:2 (YCbCr)	10	60p, 59.94p, 50p, 48p, 47.95p	O	●	O
ST 425-1 (ST 296)	3G Level A (2)	1280 x 720	4:4:4 (YCbCr/RGB) 4:4:4:4 (YCbCrA/RGBA)	10	60p, 59.94p, 50p, 30p, 29.97p	O	●	O
ST 425-1 (ST 274)	3G Level A (2)	1920 x 1080	4:4:4 (YCbCr/RGB) 4:4:4:4 (YCbCrA/RGBA)	10	60i, 59.94i, 50i, 30p, 29.97p, 25p, 24p, 23.98p, 30psF, 29.97psF, 25psF, 24psF, 23.98psF	O	●	O
ST 425-1 (ST 2048-2)	3G Level A (2)	2048 x 1080	4:4:4 (YCbCr/RGB) 4:4:4:4 (YCbCrA/RGBA)	10	30p, 29.97p, 25p, 24p, 23.98p, 30psF, 29.97psF, 25psF, 24psF, 23.98psF	O	●	O
ST 425-1 (ST 274)	3G Level A (3)	1920 x 1080	4:4:4 (YCbCr/RGB)	12	60i, 59.94i, 50i, 30p, 29.97p, 25p, 24p, 23.98p	O	●	O
ST 425-1 (ST 2048-2)	3G Level A (3)	2048 x 1080	4:4:4 (YCbCr/RGB)	12	30p, 29.97p, 25p, 24p, 23.98p, 30psF, 29.97psF, 25psF, 24psF, 23.98psF	O	●	O
ST 425-1 (ST 274)	3G Level A (4)	1920 x 1080	4:2:2 (YCbCr)	12	60i, 59.94i, 50i, 30p, 29.97p, 25p, 24p, 23.98p, 30psF, 29.97psF, 25psF, 24psF, 23.98psF	O	●	O
ST 425-1 (ST 2048-2)	3G Level A (4)	2048 x 1080	4:2:2 (YCbCr) 4:2:2:4 (YCbCrA)	12	30p, 29.97p, 25p, 24p, 23.98p, 30psF, 29.97psF, 25psF, 24psF, 23.98psF	O	●	O
ST 425-1 (ST 274)	3G Level B-DL	1920 x 1080	4:2:2 (YCbCr)	10	60p, 59.94p, 50p	O	●	O
ST 425-1 (ST 2048-2)	3G Level B-DL	2048 x 1080	4:2:2 (YCbCr)	10	60p, 59.94p, 50p, 48p, 47.95p	O	●	O
ST 425-1 (ST 274)	3G Level B-DL (II)	1920 x 1080	4:4:4 (YCbCr/RGB) 4:4:4:4 (YCbCrA/RGBA)	10	30p, 29.97p, 25p, 24p, 23.98p	A	●A	A
ST 425-1 (ST 2048-2)	3G Level B-DL (II)	2048 x 1080	4:4:4 (YCbCr/RGB) 4:4:4:4 (YCbCrA/RGBA)	10	30p, 29.97p, 25p, 24p, 23.98p	A	●A	A
ST 425-1 (ST 274)	3G Level B-DL (III)	1920 x 1080	4:4:4 (YCbCr/RBG)	12	30p, 29.97p, 25p, 24p, 23.98p	A	●A	A
ST 425-1 (ST 2048-2)	3G Level B-DL (III)	2048 x 1080	4:4:4 (YCbCr/RBG)	12	30p, 29.97p, 25p, 24p, 23.98p	A	●A	A
ST 425-1 (ST 274)	3G Level B-DL (IV)	1920 x 1080	4:2:2 (YCbCr)	12	30p, 29.97p, 25p, 24p, 23.98p,	A	●A	A
ST 425-1 (ST 2048-2)	3G Level B-DL (IV)	2048 x 1080	4:2:2 (YCbCr)	12	30p, 29.97p, 25p, 24p, 23.98p	A	●A	A
ST 425-1 (ST 2048-2)	3G Level B-DL (IV)	2048 x 1080	4:2:2:4 (YCbCrA)	12	30p, 29.97p, 25p, 24p, 23.98p	A	●A	A

The following ST 2110 formats are optional on Qx [PHQXO-IP-STND] and standard on QxL.

Resolution	Sampling Structure	Pixel Depth	Frame/Field Rate	HDR	2110
1280 x 720	4:2:2 (YCbCr)	10	60p, 59.94p, 50p, 30p, 29.97p, 25p	O	O
1920 x 1080	4:2:2 (YCbCr)	10	60i, 59.94i, 50i	O	O
1920 x 1080	4:2:2 (YCbCr)	10	30p, 29.97p, 25p, 24p, 23.98p	O	O
1920 x 1080	4:2:2 (YCbCr)	10	30psF, 29.97psF, 25psF, 24psF, 23.98psF	O	O
2048 x 1080	4:2:2 (YCbCr)	10	30p, 29.97p, 25p, 24p, 23.98p, 30psF, 29.97psF, 25psF, 24psF, 23.98psF	O	O
1920 x 1080	4:2:2 (YCbCr)	10	60p, 59.94p, 50p	O	O
2048 x 1080	4:2:2 (YCbCr)	10	60p, 59.94p, 50p, 48p, 47.95p	O	O

KEY
 ● - Generator and Analyzer as Standard (Unless Standard for Analyzer Only)
 O - Optional
 A - Analyzer Only

Supported 4K/UHD Formats

The following SDI formats are optional on Qx [PHQXO-UHD] and on QxL [PHQXO-UHD + PHQXL01-3G / PHQXL01E-3G]

SMPTE Stnds. Link (Content)	Interface	Resolution	Sampling Structure	Pixel Depth	Frame/Field Rate	HDR	SDI
ST 425-3 Annex B.1 (ST 2036-1)	Quad-link HD-SQ	3840 x 2160	4:2:2 (YCbCr)	10	30p, 29.97p, 25p, 24p, 23.98p	O	O
ST 425-3 Annex B.1 (ST 2048-1)	Quad-link HD-SQ	4096 x 2160	4:2:2 (YCbCr)	10	30p, 29.97p, 25p, 24p, 23.98p	O	O
ST 2081-10 M1 (ST 2036-1)	6G-2SI	3840 x 2160	4:2:2 (YCbCr)	10	30p, 29.97p, 25p, 24p, 23.98p	O	O
ST 2081-10 M1 (ST 2048-1)	6G-2SI	4096 x 2160	4:2:2 (YCbCr)	10	30p, 29.97p, 25p, 24p, 23.98p	O	O
ST 425-5 (ST 2036-1)	Quad-link 3G-A (1) 2SI	3840 x 2160	4:2:2 (YCbCr)	10	60p, 59.94p, 50p	O	O
ST 425-5 (ST 2048-1)	Quad-link 3G-A (1) 2SI	4096 x 2160	4:2:2 (YCbCr)	10	60p, 59.94p, 50p, 48p, 47.95p	O	O
ST 425-5 (ST 2036-1)	Quad-link 3G-A, (1) 2SI	3840 x 2160	4:4:4 (YCbCr/RGB)	10	30p, 29.97p, 25p, 24p, 23.98p	O	O
ST 425-5 (ST 2036-1)	Quad-link 3G-A, (3) 2SI	3840 x 2160	4:4:4 (YCbCr/RGB)	12	30p, 29.97p, 25p, 24p, 23.98p	O	O
ST 425-5 (ST 2036-1)	Quad-link 3G-A, B (4) 2SI	3840 x 2160	4:2:2 (YCbCr)	12	30p, 29.97p, 25p, 24p, 23.98p	O	O
ST 425-5 (ST 2048-1)	Quad-link 3G-A (4) 2SI	4096 x 2160	4:2:2 (YCbCr) 4:2:2:4 (YCbCrA)	12	30p, 29.97p, 25p, 24p, 23.98p	O	O
ST 425-5 Annex B (ST 2036-1)	Quad-link 3G-A, B (1) SQ	3840 x 2160	4:2:2 (YCbCr)	10	60p, 59.94p, 50p	O	O
ST 425-5 Annex B (ST 2048-1)	Quad-link 3G-A, B (1) SQ	4096 x 2160	4:2:2 (YCbCr)	10	60p, 59.94p, 50p, 48p, 47.95p	O	O
ST 425-5 Annex B (ST 2036-1)	Quad-link 3G-A (2) SQ	3840 x 2160	4:4:4 (YCbCr/RGB)	10	30p, 29.97p, 25p, 24p, 23.98p	O	O
ST 425-5 Annex B (ST 2036-1)	Quad-link 3G-A (3) SQ	3840 x 2160	4:4:4 (YCbCr/RGB)	12	30p, 29.97p, 25p, 24p, 23.98p	O	O
ST 425-5 Annex B (ST 2036-1)	Quad-link 3G-A (4) SQ	3840 x 2160	4:2:2 (YCbCr)	12	30p, 29.97p, 25p, 24p, 23.98p	O	O
ST 425-5 Annex B (ST 2048-1)	Quad-link 3G-A (4) SQ	4096 x 2160	4:2:2 (YCbCr)	12	30p, 29.97p, 25p, 24p, 23.98p	O	O
ST 425-5 Annex B (ST 2048-1)	Quad-link 3G-A (4) SQ	4096 x 2160	4:2:2:4 (YCbCrA)	12	30p, 29.97p, 25p, 24p, 23.98p	O	O
ST 2081-11 M1, ST 425-5 (ST 2036-1)	Dual-link 6G-2SI (II)	3840 x 2160	4:4:4 (YCbCr/RGB)	10	30p, 29.97p, 25p, 24p, 23.98p	O	O
ST 2081-11 M1, ST 425-5 (ST 2048-1)	Dual-link 6G-2SI (II)	4096 x 2160	4:4:4 (YCbCr/RGB) 4:4:4:4 (YCbCrA/RGBA)	10	30p, 29.97p, 25p, 24p, 23.98p	O	O
ST 2081-11 M1 ST 425-5 (ST 2036-1)	Dual-link 6G-2SI (III)	3840 x 2160	4:4:4 (YCbCr/RGB)	12	30p, 29.97p, 25p, 24p, 23.98p	O	O
ST 2081-11 M1, ST 425-5 (ST 2048-1)	Dual-link 6G-2SI (III)	4096 x 2160	4:4:4 (YCbCr/RGB)	12	30p, 29.97p, 25p, 24p, 23.98p	O	O
ST 2081-11 M1 ST 425-5 (ST 2036-1)	Dual-link 6G-2SI (IV)	3840 x 2160	4:2:2 (YCbCr/RGB)	12	30p, 29.97p, 25p, 24p, 23.98p	O	O
ST 2081-11 M1 ST 425-5 (ST 2048-1)	Dual-link 6G-2SI (IV)	4096 x 2160	4:2:2 (YCbCr) 4:2:2:4 (YCbCrA)	12	30p, 29.97p, 25p, 24p, 23.98p	O	O
ST 2082-10 M1, ST 425-5 (ST 2036-1)	12G-2SI (I)	3840 x 2160	4:2:2 (YCbCr)	10	60p, 59.94p, 50p	O	O
ST 2082-10 M1, ST 425-5 (ST 2048-1)	12G-2SI (I)	4096 x 2160	4:2:2 (YCbCr)	10	60p, 59.94p, 50p, 48p, 47.95p	O	O
ST 2082-10 M1 ST 425-5 (ST 2036-1)	12G -2SI (II)	3840 x 2160	4:4:4 (YCbCr/RGB)	10	30p, 29.97p, 25p, 24p, 23.98p	O	O
ST 2082-10 M1 ST 425-5 (ST 2048-1)	12G -2SI (II)	4096 x 2160	4:4:4 (YCbCr/RGB) 4:4:4:4 (YCbCrA/RGBA)	10	30p, 29.97p, 25p, 24p, 23.98p	O	O
ST 2082-10 M1 ST 425-5 (ST 2036-1)	12G-2SI (III)	3840 x 2160	4:4:4 (YCbCr/RGB)	12	30p, 29.97p, 25p, 24p, 23.98p	O	O
ST 2082-10 M1 ST 425-5 (ST 2048-1)	12G-2SI (III)	4096 x 2160	4:4:4 (YCbCr/RGB)	12	30p, 29.97p, 25p, 24p, 23.98p	O	O
ST 2082-10 M1 ST 425-5 (ST 2036-1)	12G-2SI (IV)	3840 x 2160	4:2:2 (YCbCr)	12	30p, 29.97p, 25p, 24p, 23.98p	O	O
ST 2082-10 M1 ST 425-5 (ST 2048-1)	12G-2SI (IV)	4096 x 2160	4:2:2 (YCbCr) 4:2:2:4 (YCbCrA)	12	30p, 29.97p, 25p, 24p, 23.98p	O	O

The following ST 2110 formats are optional and can be added to QxL only [PHQXO-UHD]

Resolution	Sampling Structure	Pixel Depth	Frame/Field Rate	HDR	2110
3840 x 2160	4:2:2 (YCbCr)	10	60p, 59.94p, 50p, 30p, 29.97p, 25p, 24p, 23.98p	O	O
4096 x 2160	4:2:2 (YCbCr)	10	60p, 59.94p, 50p, 48p, 47.95p, 30p, 29.97p, 25p, 24p, 23.98p	O	O

KEY
O - Optional
A - Analyzer Only

Ordering Qx

Qx Chassis (includes PHQXO-SDI-STND)

PHQX01-3G	Qx 1U ½ rack HD/2K SDI Rasterizer, Analyzer only
PHQX01E-3G	Qx 1U ½ rack HD/2K SDI Rasterizer with Eye & Jitter, Analyzer only

Qx SDI Software Options

PHQXO-UHD	UHD/4K SDI license for PHQX01-3G or PHQX01E-3G (includes HD/2K extended mode formats)
PHQXO-SDI-STRESS	Advanced 12G-SDI Stress Testing Toolset (requires PHQX01E-3G, PHQXO-UHD and PHQXO-GEN)

Qx SDI/IP Software Options

PHQXO-GEN	Audio/Video Generator - SDI, ST 2022-6, ST 2110* (PHQXO-IP-STND required for ST 2022-6/2110)
PHQXO-DATA	Data View Analyzer with ANC inspector
PHQXO-HDR	HDR/WCG support, CIE 1931 chart, HDR Heatmap

Qx IP Options

PHQXO-IP-STND	IP license for ST 2022-6, ST 2110 Decap with ST 2022-7 and PTP
PHQXO-IP-MEAS	IP Network Traffic Measurement Toolset (requires PHQXO-IP-STND)
PHQXO-IP-NGT	ST 2022-6 Packet Interval Profile Generator (requires PHQXO-IP-STND, PHQXO-GEN)
PHSFP-10GE-SR	10GBASE-SR Ethernet short range SFP+ 850nm, 300m, multi-mode transceiver
PHSFP-10GE-LR	10GBASE-LR Ethernet long range SFP+ 1310nm, 10km, single mode transceiver

Qx Fitting Kits

PHQXK1	Qx 19" rack mount kit (1x Qx chassis)
PHQXK2	Qx 19" rack mount kit (2x Qx chassis)
PHQXK3	Qx Mounting kit – 9.5" rack (1x Qx chassis)

Qx Extended Warranty

PHQX-3YEAR	3 Year Warranty**
PHQX-5YEAR	5 Year Warranty**

Ordering QxL

QxL Chassis (includes PHQXO-IP-STND)

PHQXL	QxL 1U ½ rack HD/2K IP Rasterizer, Analyzer only
PHQXL01-3G	QxL 1U ½ rack HD/2K IP/SDI Rasterizer, Analyzer only
PHQXL01E-3G	QxL 1U ½ rack HD/2K IP/SDI Rasterizer with Eye & Jitter, Analyzer only

QxL SDI Software Options

PHQXO-SDI-STRESS	Advanced 12G-SDI Stress Testing Toolset (requires PHQXL01E-3G, PHQXO-UHD and PHQXO-GEN)
------------------	---

QxL SDI/IP Software Options

PHQXO-UHD	UHD/4K payload license (includes HD/2K extended mode formats)
PHQXO-GEN	Audio/Video Test Signal Generator - SDI, ST 2022-6, ST 2110* (PHQXL01-3G, PHQXL01E-3G required for SDI)
PHQXO-DATA	Data View Analyzer with ANC inspector
PHQXO-HDR	HDR/WCG support, CIE 1931 chart, HDR Heatmap

QxL IP Options

PHQXO-IP-25G	25G IP License
PHQXO-IP-MEAS	IP Network Traffic Measurement Toolset
PHQXO-IP-NGT	ST 2022-6 Packet Interval Profile Generator (requires PHQXO-GEN)
PHSFP-10GE-SR	10GBASE-SR Ethernet short range SFP+ 850nm, 300m, multi-mode transceiver
PHSFP-10GE-LR	10GBASE-LR Ethernet long range SFP+ 1310nm, 10km, single mode transceiver
PHSFP-25GE-SR	25GBASE-SR Ethernet short range SFP28 850nm, 100m, multi-mode transceiver
PHSFP-25GE-LR	25GBASE-LR Ethernet long range SFP28 1310nm, 10km, single mode transceiver

QxL Fitting Kits

PHQXK1	Qx 19" rack mount kit (1x Qx chassis)
PHQXK2	Qx 19" rack mount kit (2x Qx chassis)
PHQXK3	Qx Mounting kit – 9.5" rack (1x Qx chassis)

QxL Extended Warranty

PHQXL-3YEAR	3 Year Warranty**
PHQXL-5YEAR	5 Year Warranty**

* Upcoming software release

** One year warranty included as standard

Dimensions and Installation

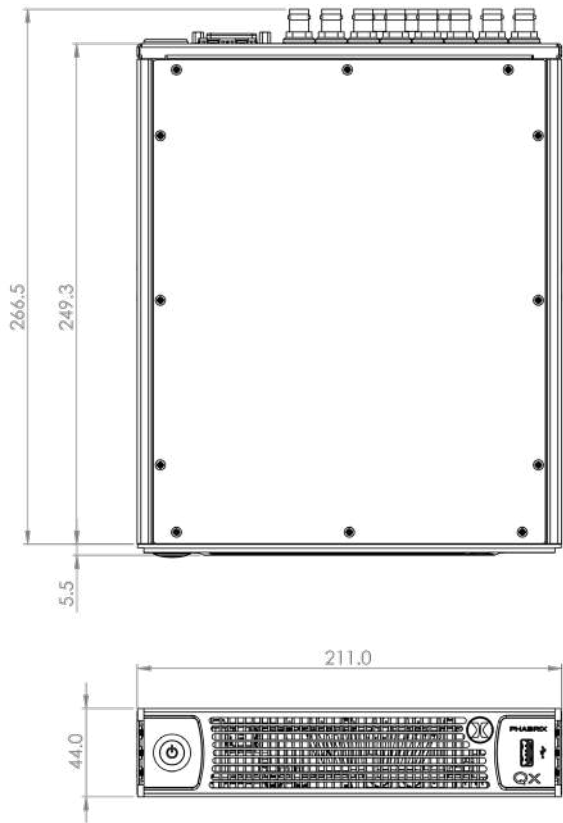

Desktop

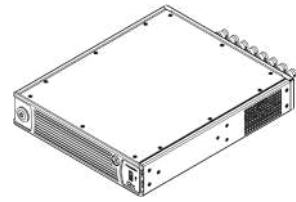

Single Rack mount tray with cover
PHQXK1

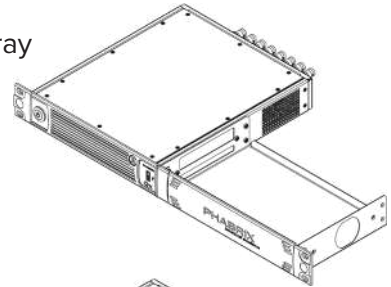

Dual Rack mount
PHQXK2

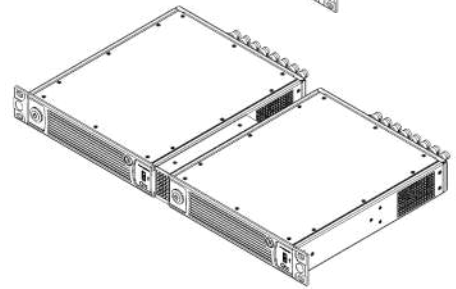



PHABRIX®

For more information about IP, SDI,
4K/UHD and HDR contact:

www.phabrix.com

