NI-9246

Specifications

2024-08-07



Contents

NI 9246 Datasheet	3
NI C Series Overview	4
CompactRIO	5
CompactDAQ	5
Software	6
NI 9246 Theory of Operation	7
Circuitry	7
DC Offset Currents	8
Performing Analysis with DC-Sensitive Algorithms	8
Correcting Faulty Measurements	9
Performing Indirect Current Measurements	9
Filtering	10
Passband	11
Stopband	11
Alias-Free Bandwidth	11
Data Rates	11
NI 9246 Specifications	12
Safety	21
Electromagnetic Compatibility	21
CE Compliance	22
Product Certifications and Declarations	22
Shock and Vibration	22
Environmental	23
Environmental Management	23
EU and UK Customers	24
电子信息产品污染控制管理办法（中国RoHS）	24
Calibration	24

NI 9246 Datasheet



- 3 isolated analog input channels, 50 kS/s per channel simultaneous sample rate
- 22 Arms continuous, ± 30 Apeak input range, 24-bit resolution (AC signals only)
- Designed for 1 A/5 A nominal CTs
- Up to 300 Vrms Channel-to-Earth and 480 Vrms Channel-to-Channel CAT III isolation
- Ring lug connectors for up to 10 AWG cables
- $-40\text{ }^{\circ}\text{C}$ to $70\text{ }^{\circ}\text{C}$ operating temperature, 5 g vibration, 50 g shock

The NI 9246 current input module is a three channel 22 Arms module designed to support direct ring lug connectivity to three-phase high-current measurements of 1A and 5A current transformers (CTs). The NI 9246 is optimized for power, energy, and industrial applications that require continuous AC measurements up to 22 Arms, ± 30 Apeak, and withstand over 1250 Arms for one cycle.

The safety features, certifications, input ranges, overvoltage ranges, and connectivity will help engineers with applications such as:

- Power quality monitoring and metering
- Utility pole-mounted smart switches
- Utility pole-mounted smart grid reclosers
- Substation merging units
- Industrial machine measurements
 - Health monitoring
 - Predictive maintenance and prognosis

- Phasor Measurement Units (PMUs)
- General purpose AC current testing

	<p>Kit Contents</p>	<ul style="list-style-type: none"> • NI 9246 • High Voltage Backshell • NI 9246 Getting Started Guide
	<p>Recommended Accessories</p>	<ul style="list-style-type: none"> • Ring Lugs (Quantity: 6)

C SERIES 9227, 9246, 9247 CURRENT INPUT MODULE COMPARISON								
Product Name	Channels	Input Coupling	Input Noise	Measurement Range		1 s Withstand	Isolation	Connectivity
				Continuous	Instantaneous			
NI 9227	4	DC	0.4 mArms	5 Arms	10 Arms ±14 Apeak	10 Arms	CAT II 250 Vrms Ch-Ch	Screw Terminal
NI 9246	3	AC	0.25 mArms	20 Arms	20 Arms ±30 Apeak	500 Arms	CAT III 480 Vrms Ch-Ch	Ring Lug
NI 9247	3	AC	2.250 mArms	50 Arms	100 Arms ±147 Apeak	500 Arms	CAT III 480 Vrms Ch-Ch	Ring Lug

© 2015 National Instruments Corporation. All rights reserved. Refer to the <National Instruments>_Legal Information directory for information about NI copyright, patents, trademarks, warranties, product warnings, and export compliance.

NI C Series Overview



NI provides more than 100 C Series modules for measurement, control, and communication applications. C Series modules can connect to any sensor or bus and allow for high-accuracy measurements that meet the demands of advanced data

acquisition and control applications.

- Measurement-specific signal conditioning that connects to an array of sensors and signals
- Isolation options such as bank-to-bank, channel-to-channel, and channel-to-earth ground
- -40 °C to 70 °C temperature range to meet a variety of application and environmental needs
- Hot-swappable

The majority of C Series modules are supported in both CompactRIO and CompactDAQ platforms and you can move modules from one platform to the other with no modification.

CompactRIO



CompactRIO combines an open-embedded architecture with small size, extreme ruggedness, and C Series modules in a platform powered by the NI LabVIEW reconfigurable I/O (RIO) architecture. Each system contains an FPGA for custom timing, triggering, and processing with a wide array of available modular I/O to meet any embedded application requirement.

CompactDAQ

CompactDAQ is a portable, rugged data acquisition platform that integrates connectivity, data acquisition, and signal conditioning into modular I/O for directly interfacing to any sensor or signal. Using CompactDAQ with LabVIEW, you can easily customize how you acquire, analyze, visualize, and manage your measurement data.



Software

LabVIEW Professional Development System for Windows



- Use advanced software tools for large project development
- Generate code automatically using DAQ Assistant and Instrument I/O Assistant
- Use advanced measurement analysis and digital signal processing
- Take advantage of open connectivity with DLLs, ActiveX, and .NET objects
- Build DLLs, executables, and MSI installers

NI LabVIEW FPGA Module



- Design FPGA applications for NI RIO hardware
- Program with the same graphical environment used for desktop and real-time applications
- Execute control algorithms with loop rates up to 300 MHz
- Implement custom timing and triggering logic, digital protocols, and DSP algorithms
- Incorporate existing HDL code and third-

NI LabVIEW FPGA Module

party IP including Xilinx IP generator functions

- Purchase as part of the LabVIEW Embedded Control and Monitoring Suite

NI LabVIEW Real-Time Module

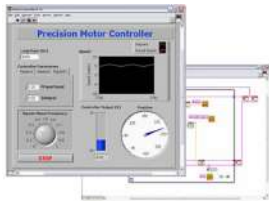

- Design deterministic real-time applications with LabVIEW graphical programming
- Download to dedicated NI or third-party hardware for reliable execution and a wide selection of I/O
- Take advantage of built-in PID control, signal processing, and analysis functions
- Automatically take advantage of multicore CPUs or set processor affinity manually
- Take advantage of real-time OS, development and debugging support, and board support
- Purchase individually or as part of a LabVIEW suite

NI 9246 Theory of Operation

The NI 9246 measures currents that flow into AI+ and out of AI- as positive polarity. A + or - symbol is molded into the plastic near the respective ring lug terminal for each channel. Each channel is independently isolated from other channels and earth ground. The isolation ratings of 300 Vrms to Earth and 480 Vrms between channels makes the inputs suitable for direct current measurements at line voltages up to 277 V/ 480 V Cat III three-phase service levels.

Circuitry

Each input signal of the NI 9246 is isolated, AC coupled, and then sampled by a single 24-bit ADC.

Figure 1. NI 9246 Input Circuitry

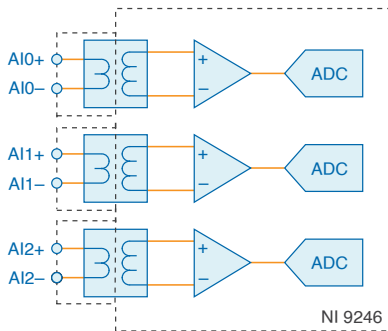

Note The NI 9246 does not measure DC currents.



Caution Connecting a DC current source to the NI 9246 outside of the input characteristics specifications may lead to invalid measurements.

The NI 9246 is suited for connection to the outputs of current transformers with 1 A or 5 A nominal ratings.

DC Offset Currents



Note The NI 9246 does not measure DC currents.

The NI 9246 inputs are AC coupled through an internal transformer. Refer to the [Input Characteristics](#) section for information about the residual DC offset error the NI 9246 measures.

The DC value is ignored when you make frequency-specific measurements, such as harmonic analysis, phasor measurements, or fundamental line frequency amplitude measurements using algorithms such as those included with the NI LabVIEW Electrical Power Suite.

Performing Analysis with DC-Sensitive Algorithms

If you perform analyses with DC-sensitive algorithms, such as instantaneous absolute peak detection or absolute value measurements, you should first remove the DC component of your measured waveforms by using a high-pass digital filter or by subtracting the average value of an integer number of power line cycles from your measurements.



Caution Connecting a DC current source to the NI 9246 outside of the specifications listed in the [Input Characteristics](#) section can lead to invalid measurements.

Correcting Faulty Measurements

Although the NI 9246 cannot measure DC inputs, excessive DC components in the input currents will saturate the internal transformer and cause erroneous measurements. Refer to the [Input Characteristics](#) section for the typical limits of DC current that are tolerated before saturation begins. DC currents can occur in specific situations, such as with direct current measurements of a load. The following figure illustrates how faulty full-wave rectifiers in a load can cause half-wave rectification of a load, resulting in a DC offset.

Figure 2. Half-wave Rectification of a Load, Resulting in DC Offset



With complete half-wave rectification, the DC component of the input current is $1/\pi$ x the peak current, and the RMS value is one half the peak current. In this scenario, the DC value must remain under the continuous allowed DC offset specification for correct measurements of the AC component of the waveform.

Performing Indirect Current Measurements

When you use the NI 9246 to indirectly measure current through a current transformer, the current transformer blocks continuous DC currents from reaching the inputs of the NI 9246. Temporary offsets of the AC signal can still occur. In a network modeled as a first order system with a reactance to resistance ration of X/R , short circuit faults result

in an offset current that decays with a time constant equal to $(X/R) \div 2\pi f_{\text{line}}$. For example, in a network with an X/R ratio of 32 and a line frequency of 50 Hz, the offset decays with a time constant of 100 ms. An X/R of 120 at 60 Hz decays with a time constant of 320 ms, as shown in the following figure. Refer to the [Input Characteristics](#) section for peak offset currents with first order decay limits. Peak offsets that exceed these limits can cause erroneous readings.

Figure 3. +5 A Input with +5 A Offset, Decaying at 320 ms

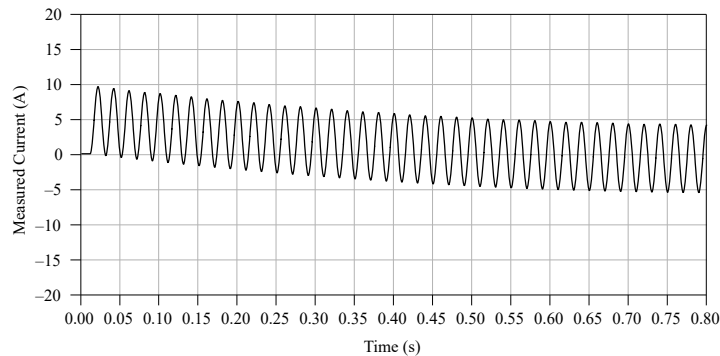

The following figure shows an excessive offset that causes saturation of the internal transformer and the resulting impact on measured current.

Figure 4. +10 A Input with +10 A Offset, Decaying at 320 ms

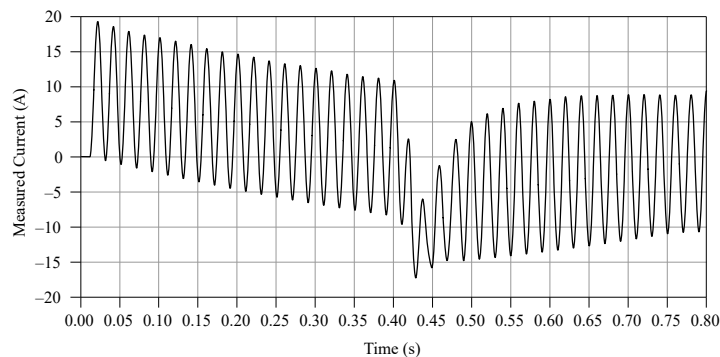

Filtering

The NI 9246 uses a combination of analog and digital filtering to provide an accurate representation of in-band signals and reject out-of-band signals. The filters discriminate between signals based on the frequency range, or bandwidth, of the signal. The three important bandwidths to consider are the passband, the stopband, and the anti-imaging bandwidth.

The NI 9246 represents signals within the passband, as quantified primarily by passband ripple and phase nonlinearity. All signals that appear in the alias-free bandwidth are either unaliased signals or signals that have been filtered by at least the amount of the stopband rejection.

Passband

The signals within the passband have frequency-dependent gain or attenuation. The small amount of variation in gain with respect to frequency is called the passband flatness. The digital filters of the NI 9246 adjust the frequency range of the passband to match the data rate. Therefore, the amount of gain or attenuation at a given frequency depends on the data rate.

Stopband

The filter significantly attenuates all signals above the stopband frequency. The primary goal of the filter is to prevent aliasing. Therefore, the stopband frequency scales precisely with the data rate. The stopband rejection is the minimum amount of attenuation applied by the filter to all signals with frequencies within the stopband.

Alias-Free Bandwidth

Any signals that appear in the alias-free bandwidth are not aliased artifacts of signals at a higher frequency. The alias-free bandwidth is defined by the ability of the filter to reject frequencies above the stopband frequency. The alias-free bandwidth is equal to the data rate minus the stopband frequency.

Data Rates

The frequency of a master timebase (f_M) controls the data rate (f_s) of the NI 9246. The NI 9246 includes an internal master timebase with a frequency of 12.8 MHz, but the module also can accept an external master timebase or export its own master timebase. To synchronize the data rate of an NI 9246 with other modules that use master timebases to control sampling, all of the modules must share a single master timebase source.

The following equation provides the available data rates of the NI 9246:

$$f_s = \frac{f_M \div 256}{n}$$

where n is any integer from 1 to 31.

However, the data rate must remain within the appropriate data rate range. When using the internal master timebase of 12.8 MHz, the result is data rates of 50 kS/s, 25 kS/s, 16.667 kS/s, and so on down to 1.613 kS/s depending on the value of n. When using an external timebase with a frequency other than 12.8 MHz, the NI 9246 has a different set of data rates.



Note The NI 9151 R Series Expansion chassis does not support sharing timebases between modules.

NI 9246 Specifications

The following specifications are typical for the range -40 °C to 70 °C unless otherwise noted.



Caution Do not operate the NI 9246 in a manner not specified in this document. Product misuse can result in a hazard. You can compromise the safety protection built into the product if the product is damaged in any way. If the product is damaged, return it to NI for repair.



Caution Le NI 9246 ne doit en aucun cas être utilisé d'une autre façon que celle spécifiée dans ce document. Une mauvaise utilisation du produit peut s'avérer dangereuse. Si le produit est endommagé de quelque manière que ce soit, la sécurité intégrée dans le produit risque d'en être compromise. Si le produit est endommagé, le renvoyer à NI pour réparation.

Input Characteristics

Number of channels	3 analog input channels	
ADC resolution	24 bits	
Type of ADC	Delta-Sigma (with analog prefiltering)	
Sampling mode	Simultaneous	
Instantaneous measuring range		
Minimum	±30.6 A	
Typical	±31.25 A	
Typical scaling coefficient	3.7253 $\mu\text{A}/\text{LSB}$	
Operating input rating	22 Arms	
Overcurrent withstand rating	50 Arms continuously; 100 Arms for 10 seconds, not to repeat more than once in 30 minutes; 500 Arms for 1 second, not to repeat more than once in 30 minutes; 1250 Arms for 1 cycle(20 ms), not to repeat more than once in a minute	

Input coupling	AC
Input impedance	0.2 mΩ
Internal master timebase (f_M)	
Frequency	12.8 MHz
Accuracy	±100 ppm max
Data rate range (f_S) using internal master timebase	
Minimum	1.613 kS/s
Maximum	50 kS/s
Data rate range (f_S) using external master timebase	
Minimum	390.625 S/s
Maximum	51.2 kS/s

Data rates (f_S)

$$\frac{f_M \div 256}{n}, n = 1, 2, \dots, 31 \quad \frac{f_M \div 256}{n}, n = 1, 2, \dots, 31$$

Passband frequency	10 Hz to 0.453 · f _S
--------------------	---------------------------------

Passband flatness ^[1]	
10 Hz to 6 kHz	±0.1% (±0.01 dB)
6 kHz to 22.5 kHz	±1.5% (±0.13 dB)
Alias-free bandwidth	$0.453 \cdot f_s$
Stopband frequency	$0.547 \cdot f_s$
Stopband attenuation	95 dB
Input noise	
1 Hz to 25 kHz bandwidth ($f_s = 50$ kS/s)	0.25 mArms
25 Hz to 75 Hz or 30 Hz to 90 Hz bandwidth ^[2]	0.035 mArms

Table 1. Amplitude Accuracy (Gain Error)

Measurement Conditions	Percent of Reading: 1 Arms to 15 Arms	Percent of Reading: 0 Arms to 20 Arms	
		10 Hz to 6 kHz	6 kHz to 22.5 kHz
Calibrated typical (23 °C, ±5 °C)	0.1%	0.2%	0.5%
Calibrated max (-40 °C to 70 °C)	0.5%	0.7%	2.0%
Uncalibrated ^[3] typical (23 °C, ±5 °C)	0.8%	0.9%	1.0%
Uncalibrated ³ max	2.0%	2.2%	3.5%

Measurement Conditions	Percent of Reading: 1 Arms to 15 Arms	Percent of Reading: 0 Arms to 20 Arms	
(-40 °C to 70 °C)			

Gain drift	±15 ppm/°C		
Gain mismatch between channels (with the same amplitude and frequency on each channel)			
10 Hz to 6 kHz	0.5% max		
6 kHz to 22.5 kHz	1.7% max		
Input delay	$(40 + [5/512])/f_s + 3.2 \mu s$		

Table 2. Phase Error (0 A to 15 A)

Measurement Conditions	Phase Error ^[4]	
	10 Hz to 40 Hz	40 Hz to 3500 Hz
Typical (23 °C, ±5 °C)	0.2°	0.04°
Max (-40 °C to 70 °C)	0.5°	0.13°

Phase error, 3500 Hz to 22.5 kHz	±0.07°/kHz	
Additional phase error above 15 A	±0.15°/A above 15 A	
Phase mismatch between channels (with the same frequency on each channel)		
10 Hz to 40 Hz	1.0° max	

40 Hz to 3500 Hz	0.25° max
3.5 kHz to 22.5 kHz	±0.07°/kHz max
DC offset error	
Calibrated	±0.04 A maximum
Uncalibrated	±0.1 A maximum



Note The NI 9246 has AC coupled inputs and does not measure the DC current of the input signal. The DC offset error specification refers to the maximum possible DC value returned by the NI 9246.

Allowable DC offset input	
Continuous	1.5 A
Exponentially decaying	
100 ms	12 A _{peak}
320 ms	5 A _{peak}



Note A 100 ms time constant corresponds to X/R impedance ratios of 32 for 50 Hz signals and 38 for 60 Hz signals. 320 ms corresponds to ratios of 100 for 50 Hz and 120 for 60 Hz.



Caution Input signals that contain DC offsets that exceed the listed values

can cause erroneous measurements.

Crosstalk	
(f_{in} = 50 Hz or 60 Hz)	0.001% (-100 dB)
(f_{in} = 1 kHz)	0.002% (-94 dB)
Common Mode Rejection Ratio (CMRR)	7.5 μ A/V/Hz (375 μ A/V at 50 Hz)
Total Harmonic Distortion (THD), (f_{in} = 50 Hz or 60 Hz)	
I_{in} < 15 A	0.01% (-80 dB)
I_{in} = 15 A to 20 A	0.1% (-60 dB)

Power Requirements

Power consumption from chassis	
Active mode	0.7 W max
Sleep mode	25 μ W max
Thermal dissipation (at 70 °C)	
Active mode	2.0 W max
Sleep mode	1.5 W max

Physical Characteristics

If you need to clean the module, wipe it with a dry towel.



Tip For two-dimensional drawings and three-dimensional models of the C Series module and connectors, visit ni.com/dimensions and search by module number.

Connector wiring	
Gauge	2.58 mm ² (10 AWG) stranded core wire with an insulated ring terminal
Screw specifications	
Screw size	6-32
Maximum screw length	5.08 mm (0.200 in.)
Ring/Spade terminal	
Maximum width	9.525 mm (0.375 in.) of ring lug
Recommended torque	1.4 N · m (12 lb · in.)
Weight	248 g (8.75 oz)

Safety Voltages

Connect only voltages that are within the following limits:

Maximum working voltage, channel-to-earth ground
--

Continuous	
Up to 2,000 m altitude	300 Vrms, Measurement Category III
Up to 5,000 m altitude	150 Vrms, Measurement Category III or 300 Vrms, Measurement Category II
Maximum working voltage, channel-to-channel	
Continuous	
Up to 2,000 m altitude	480 Vrms, Measurement Category III
Up to 5,000 m altitude	300 Vrms, Measurement Category III or 480 Vrms, Measurement Category II
Withstand	
Channel-to-channel	3510 Vrms, verified by a 5 s dielectric withstand test
Channel-to-earth ground	3510 Vrms, verified by a 5 s dielectric withstand test



Caution The NI 9246 ships with a connector backshell to ensure that the terminals are not accessible. Do not operate the device without first installing this backshell.

Figure 5. NI 9246 with Backshell

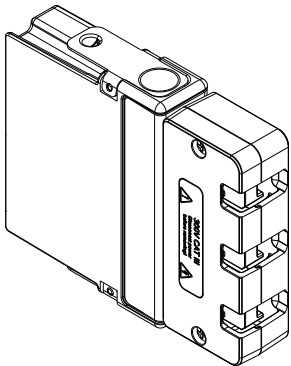

Safety

This product is designed to meet the requirements of the following electrical equipment safety standards for measurement, control, and laboratory use:

- IEC 61010-1, EN 61010-1
- UL 61010-1, CSA 61010-1



Note For UL and other safety certifications, refer to the product label or the [Online Product Certification](#) section.

Electromagnetic Compatibility

This product meets the requirements of the following EMC standards for electrical equipment for measurement, control, and laboratory use:

- EN 61326-1 (IEC 61326-1): Class A emissions; Industrial immunity
- EN 55011 (CISPR 11): Group 1, Class A emissions
- EN 55022 (CISPR 22): Class A emissions
- EN 55024 (CISPR 24): Immunity
- AS/NZS CISPR 11: Group 1, Class A emissions
- AS/NZS CISPR 22: Class A emissions
- FCC 47 CFR Part 15B: Class A emissions
- ICES-001: Class A emissions



Note In the United States (per FCC 47 CFR), Class A equipment is intended for use in commercial, light-industrial, and heavy-industrial locations. In Europe, Canada, Australia and New Zealand (per CISPR 11) Class A equipment is intended for use only in heavy-industrial locations.



Note Group 1 equipment (per CISPR 11) is any industrial, scientific, or medical equipment that does not intentionally generate radio frequency energy for the treatment of material or inspection/analysis purposes.



Note For EMC declarations and certifications, and additional information, refer to the [Online Product Certification](#) section.

CE Compliance

This product meets the essential requirements of applicable European Directives, as follows:

- 2014/35/EU; Low-Voltage Directive (safety)
- 2014/30/EU; Electromagnetic Compatibility Directive (EMC)

Product Certifications and Declarations

Refer to the product Declaration of Conformity (DoC) for additional regulatory compliance information. To obtain product certifications and the DoC for NI products, visit ni.com/product-certifications, search by model number, and click the appropriate link.

Shock and Vibration

To meet these specifications, you must panel mount the system.

Operating vibration	
Random (IEC 60068-2-64)	5 grms, 10 Hz to 500 Hz
Sinusoidal (IEC 60068-2-6)	5 g, 10 Hz to 500 Hz
Operating shock (IEC 60068-2-27)	30 g, 11 ms half sine; 50 g, 3 ms half sine; 18 shocks at 6 orientations

Environmental

Refer to the manual for the chassis you are using for more information about meeting these specifications.

Operating temperature (IEC 60068-2-1, IEC 60068-2-2)	-40 °C to 70 °C
Storage temperature (IEC 60068-2-1, IEC 60068-2-2)	-40 °C to 85 °C
Ingress protection (with power plug attached)	IP 40
Operating humidity (IEC 60068-2-78)	10% RH to 90% RH, noncondensing
Storage humidity (IEC 60068-2-78)	5% RH to 95% RH, noncondensing
Pollution Degree	2
Maximum altitude	5,000 m

Indoor use only.

Environmental Management

NI is committed to designing and manufacturing products in an environmentally responsible manner. NI recognizes that eliminating certain hazardous substances from our products is beneficial to the environment and to NI customers.

For additional environmental information, refer to the ***Engineering a Healthy***

Planet web page at ni.com/environment. This page contains the environmental regulations and directives with which NI complies, as well as other environmental information not included in this document.

EU and UK Customers

-  **Waste Electrical and Electronic Equipment (WEEE)**—At the end of the product life cycle, all NI products must be disposed of according to local laws and regulations. For more information about how to recycle NI products in your region, visit ni.com/environment/weee.

电子信息产品污染控制管理办法（中国RoHS）

-  **中国RoHS**—NI符合中国电子信息产品中限制使用某些有害物质指令 (RoHS)。关于NI中国RoHS合规性信息，请登录 ni.com/environment/rohs_china。(For information about China RoHS compliance, go to ni.com/environment/rohs_china.)

Calibration

You can obtain the calibration certificate and information about calibration services for the NI 9246 at ni.com/calibration.

Calibration interval	1 year
----------------------	--------