PXle-1083 Specifications

2023-03-15



Contents

PXIe-1083 Specifications..... 3

PXIe-1083 Specifications

This document contains specifications for the PXIe-1083 chassis.

Electrical

The following section provides information about the PXIe-1083 AC input and DC output.

AC Input

Input rating	100 VAC to 240 VAC, 50 Hz/60 Hz, 6 A to 3 A
Operating voltage range ¹	90 VAC to 264 VAC
Nominal input frequency	50 Hz/60 Hz
Operating frequency range ¹	47 Hz to 63 Hz
Efficiency	78% typical
Over-current protection	Internal fuse in line
Main power disconnect	The AC power cable provides main power disconnect. Do not position the equipment so that it is difficult to disconnect the power cord. The front-panel power switch causes the internal chassis power supply to provide DC power to the PXI Express backplane.



Caution Disconnect power cord to completely remove power.

DC Output

DC output characteristics of the PXIe-1083.

Voltage Rail	Maximum Current	Load Regulation	Maximum Ripple and Noise (20 MHz BW)
+5V_AUX	1.0 A	±5%	50 mVpp
+12 V	30.1 A	±5%	120 mVpp
+5 V	25.1 A	±5%	50 mVpp
+3.3 V	30.7 A	±5%	50 mVpp
-12 V	0.75 A	±5%	120 mVpp

Maximum total available power for the PXIe-1083 is 293 W.

The maximum combined power available on +3.3 V and +5 V is 180 W.

The maximum power available for each Thunderbolt port is 15 W (5 V/3 A).

Table 1. Backplane Slot Current Capacity

Slot	+5 V	V (I/O)	+3.3 V	+12 V	-12 V	5 V _{AUX}
Hybrid Peripheral Slot with PXI-5 Peripheral	-	-	3 A	6 A	-	1 A
Hybrid Peripheral Slot with PXI-1 Peripheral	6 A	5 A	6 A	1 A	1 A	-



Note PCI V(I/O) pins in Hybrid Peripheral Slots are connected to +5 V.



Note The maximum power dissipated in a peripheral slot should not exceed 58 W. Refer to the **Operating Environment** section for ambient temperature considerations at 58 W.

Over-current protection	All outputs are protected from short circuit and overload, they recover and return to regulation when the overload is removed and the power is cycled.
Over-voltage protection	+3.3 V clamped at 3.7 V to 4.3 V, +5 V clamped at 5.7 V to 6.5 V, +12 V clamped at 13.4 V to 15.6 V

Chassis Cooling

Module cooling	Forced air circulation (positive pressurization) through one 150 CFM fan
Module slot airflow direction	Bottom of module to top of module
Module intake	Bottom of chassis
Module exhaust	Top, right side of chassis
Slot cooling capacity	58 W; slot 6 supports 58 W cooling with high fan mode
Power supply cooling	Forced air circulation through integrated fans
Power supply intake	Front and left side chassis
Power supply exhaust	Rear of chassis
Minimum chassis cooling clearances	

Above	44.45 mm (1.75 in.)
Rear	44.45 mm (1.75 in.)
Sides	44.45 mm (1.75 in.)
Below	
Rack	44.45 mm (1.75 in.)
Desktop	25.4 mm (1.00 in.)

Environmental

Maximum altitude	2,000 m (6,560 ft.), 800 mbar (at 25 °C ambient, high fan mode)
Pollution Degree	2

Indoor use only.

Operating Environment

Ambient temperature range	
When all peripheral modules require ≤ 38 W cooling capacity per slot	0 °C to 50 °C (IEC 60068-2-1 and IEC 60068-2-2.) ² Meets MIL-PRF-28800F Class 3 low temperature limit and high temperature limit.
When any peripheral module requires > 38 W cooling capacity per slot	0 °C to 40 °C (IEC 60068-2-1 and IEC 60068-2-2.) ² Meets MIL-PRF-28800F Class 3 low temperature limit and MIL-PRF-28800F Class 4 high temperature limit.

Relative humidity range	20% to 80%, noncondensing
-------------------------	---------------------------

Storage Environment

Ambient temperature range	-40 °C to 71 °C (IEC-60068-2-1 and IEC-60068-2-2.) ^[3] Meets MIL-PRF-28800F Class 3 limits.
Relative humidity range	10% to 95%, noncondensing

Shock and Vibration

Operational shock	30 g peak, half-sine, 11 ms pulse (IEC-60068-2-27.) ³ Meets MIL-PRF-28800F Class 2 limits.
Operational random vibration	5 to 500 Hz, 0.3 g _{rms}
Non-operating vibration	5 to 500 Hz, 2.4 g _{rms} (IEC 60068-2-64.) ³ Non-operating test profile exceeds the requirements of MIL-PRF-28800F, Class 3.

Acoustic Emissions

Sound Pressure Level (at Operator Position)

(Tested in accordance with ISO 7779. Meets MIL-PRF-28800F requirements.)

38 W Profile	
Auto fan (up to 30 °C ambient)	33.7 dBA

High fan	50.8 dBA
----------	----------

58 W Profile

Auto fan (up to 30 °C ambient)	54.7 dBA
High fan	55.3 dBA

Sound Power Level

38 W Profile

Auto fan (up to 30 °C ambient)	44.9 dBA
High fan	60.3 dBA

58 W Profile

Auto fan (up to 30 °C ambient)	63.4 dBA
High fan	64.2 dBA



Note The protection provided by the PXIe-1083 can be impaired if it is used in a manner not described in this document.

Safety Compliance Standards

This product is designed to meet the requirements of the following electrical equipment safety standards for measurement, control, and laboratory use:

- IEC 61010-1, EN 61010-1
- UL 61010-1, CSA C22.2 No. 61010-1



Note For safety certifications, refer to the product label or the [Product Certifications and Declarations](#) section.

EMC Guidelines

This product was tested and complies with the regulatory requirements and limits for electromagnetic compatibility (EMC) stated in the product specifications. These requirements and limits provide reasonable protection against harmful interference when the product is operated in the intended operational electromagnetic environment.

This product is intended for use in industrial locations. However, harmful interference may occur in some installations, when the product is connected to a peripheral device or test object, or if the product is used in residential areas. To minimize interference with radio and television reception and prevent unacceptable performance degradation, install and use this product in strict accordance with the instructions in the product documentation.

Furthermore, any changes or modifications to the product not expressly approved by NI could void your authority to operate it under your local regulatory rules.

EMC Notices

Refer to the following notices for cables, accessories, and prevention measures necessary to ensure the specified EMC performance.



Notice

For EMC declarations and certifications, and additional information, refer to the [Product Certifications and Declarations](#) section.



Notice Changes or modifications to the product not expressly approved by NI could void your authority to operate the product under your local regulatory rules.



Notice Operate this product only with shielded cables and accessories.

Electromagnetic Compatibility Standards

This product meets the requirements of the following EMC standards for electrical equipment for measurement, control, and laboratory use:

- EN 61326-1 (IEC 61326-1): Class A emissions; Basic immunity
- EN 55011 (CISPR 11): Group 1, Class A emissions
- AS/NZS CISPR 11: Group 1, Class A emissions



Note Group 1 equipment (per CISPR 11) is any industrial, scientific, or medical equipment that does not intentionally generate radio frequency energy for the treatment of material or inspection/analysis purposes.



Note In Europe, Canada, Australia, and New Zealand (per CISPR 11) Class A equipment is intended for use in nonresidential locations.

CE Compliance

This product meets the essential requirements of applicable European Directives, as follows:

- 2014/35/EU; Low-Voltage Directive (safety)
- 2014/30/EU; Electromagnetic Compatibility Directive (EMC)
- 2011/65/EU; Restriction of Hazardous Substances (RoHS)

Product Certifications and Declarations

Refer to the product Declaration of Conformity (DoC) for additional regulatory compliance information. To obtain product certifications and the DoC for NI products, visit ni.com/product-certifications, search by model number, and click the appropriate link.

Environmental Management

NI is committed to designing and manufacturing products in an environmentally responsible manner. NI recognizes that eliminating certain hazardous substances from our products is beneficial to the environment and to NI customers.

For additional environmental information, refer to the **Engineering a Healthy Planet** web page at ni.com/environment. This page contains the environmental regulations and directives with which NI complies, as well as other environmental information not included in this document.

EU and UK Customers

-  **Waste Electrical and Electronic Equipment (WEEE)**—At the end of the product life cycle, all NI products must be disposed of according to local laws and regulations. For more information about how to recycle NI products in your region, visit ni.com/environment/weee.

电子信息产品污染控制管理办法（中国 RoHS）

-  **中国 RoHS**—NI 符合中国电子信息产品中限制使用某些有害物质指令(RoHS)。关于 NI 中国 RoHS 合规性信息，请登录 ni.com/environment/rohs_china。(For information about China RoHS compliance, go to ni.com/environment/rohs_china.)

Backplane

Size	3U-sized; 5 peripheral slots. Compliant with IEEE 1101.10 mechanical packaging. PXI Express Specification compliant. Accepts both PXI Express and CompactPCI (PICMG 2.0 R 3.0) 3U modules.
Backplane bare-board material	UL 94 V-0 Recognized
Backplane connectors	Conforms to IEC 917 and IEC 1076-4-101, UL 94 V-0 rated

System Synchronization Clocks

10 MHz System Reference Clock: PXI_CLK10

Maximum slot-to-slot skew	250 ps
Accuracy	± 25 ppm max (guaranteed over the operating temperature range)
Maximum jitter	5 ps RMS phase-jitter (10 Hz–1 MHz range)
Duty-factor	45% to 55%
Unloaded signal swing	3.3 V \pm 0.3 V



Note For other specifications, refer to the **PXI-1 Hardware Specification**.

100 MHz System Reference Clock: PXIe_CLK100 and PXIe_SYNC100

Maximum slot-to-slot skew	100 ps
Accuracy	±25 ppm max (guaranteed over the operating temperature range)
Maximum jitter	3 ps RMS phase-jitter (10 Hz to 12 kHz range), 2 ps RMS phase-jitter (12 kHz to 20 MHz range)
Duty-factor for PXIe_CLK100	45% to 55%
Absolute differential voltage (When terminated with a 50 Ω load to 1.30 V or Thévenin equivalent)	400 mV to 1000 mV



Note For other specifications, refer to the **PXI-5 PXI Express Hardware Specification**.

Mechanical

Standard chassis dimensions	
Height	177.1 mm (6.97 in.)
Width	257.1 mm (10.12 in.)
Depth	214.2 mm (8.43 in.)
Weight	6.7 kg (14.8 lb)

Chassis materials	Extruded Aluminum (6063-T5, 6060-T6), Cold Rolled Steel/Stainless Steel, Santoprene, Urethane Foam, PC-ABS, Nylon, Polyethylene
Finish	Conductive Clear Iridite on Aluminum, Electroplated Nickel on Cold Rolled Steel, Electroplated Zinc on Cold Rolled Steel

The following figures show the PXIe-1083 chassis dimensions. The holes shown are for installing the optional rack mount kits.

Figure 1. PXIe-1083 Chassis Dimensions (Front)

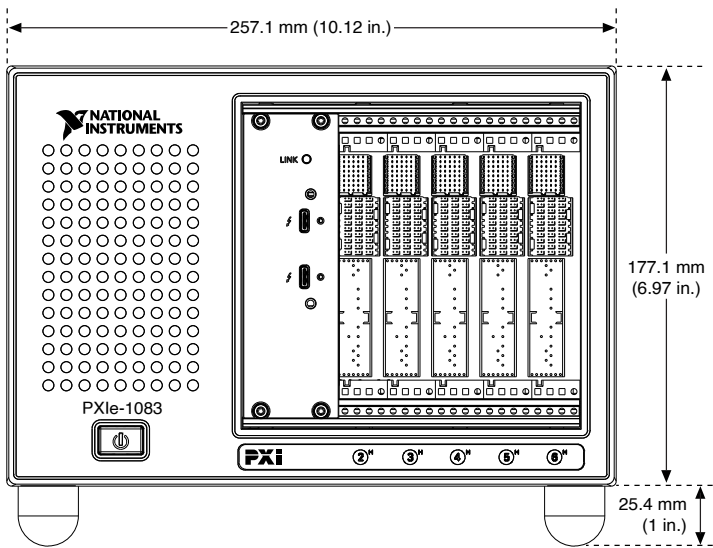

Figure 2. PXIe-1083 Chassis Dimensions (Side)

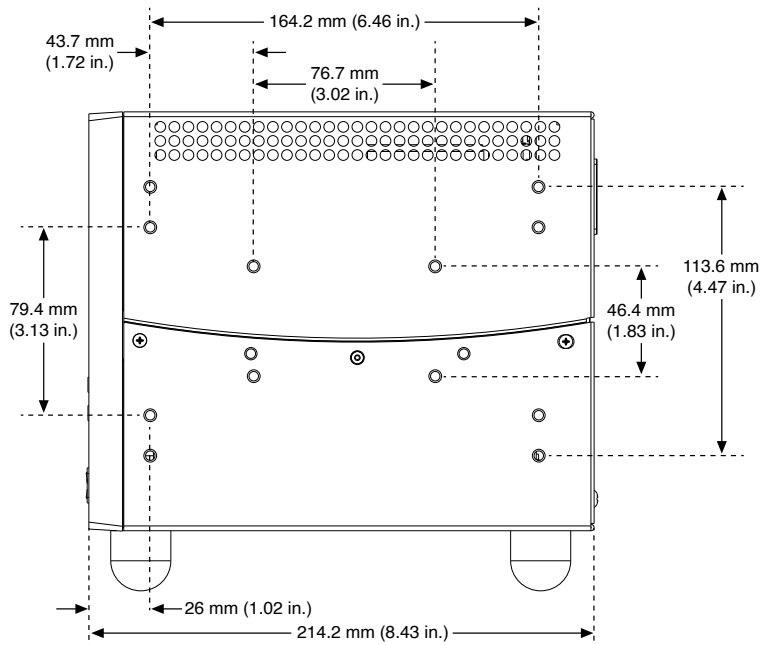
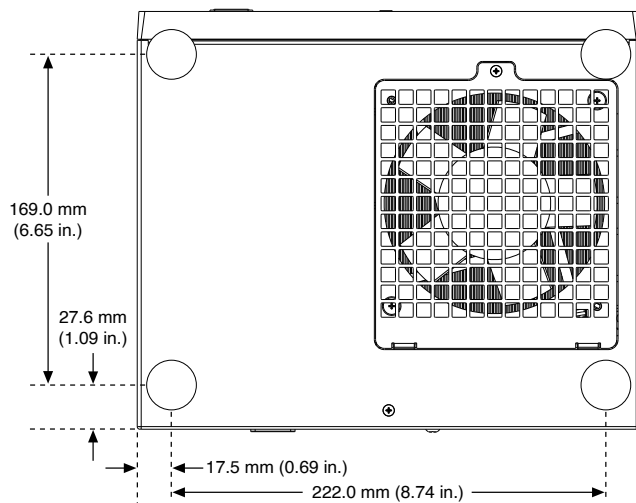

Figure 3. PXIe-1083 Chassis Dimensions (Bottom)



- ¹ The operating range is guaranteed by design.
- ² This product meets the requirements of the environmental standards for electrical equipment for measurement, control, and laboratory use.
- ³ This product meets the requirements of the environmental standards for electrical equipment for measurement, control, and laboratory use.